



VNN3NV04, VNS3NV04 VND3NV04, VND3NV04-1

OMNIFET II
fully autoprotected Power MOSFET

Features

Type	$R_{DS(on)}$	I_{lim}	V_{clamp}
VNN3NV04 VNS3NV04 VND3NV04 VND3NV04-1	120 m Ω	3.5 A	40 V

- Linear current limitation
- Thermal shutdown
- Short circuit protection
- Integrated clamp
- Low current drawn from input pin
- Diagnostic feedback through input pin
- ESD protection
- Direct access to the gate of the Power MOSFET (analog driving)
- Compatible with standard Power MOSFET in compliance with the 2002/95/EC European Directive



Description

The VNN3NV04, VNS3NV04, VND3NV04, VND3NV04-1, are monolithic devices designed in STMicroelectronics™ VIPower™ M0-3 Technology, intended for replacement of standard Power MOSFETs from DC up to 50 kHz applications. Built in thermal shutdown, linear current limitation and overvoltage clamp protect the chip in harsh environments.

Fault feedback can be detected by monitoring the voltage at the input pin.

Table 1. Device summary

Package	Order codes			
	Tube	Tube (lead-free)	Tape and reel	Tape and reel (lead-free)
SOT-223	VNN3NV04	-	VNN3NV0413TR	-
SO-8	VNS3NV04	-	VNS3NV0413TR	-
TO-252	VND3NV04	VND3NV04-E	VND3NV0413TR	VND3NV04TR-E
TO-251	VND3NV04-1	VND3NV04-1-E	-	-

Contents

1	Block diagram and pin description	5
2	Electrical specifications	6
2.1	Absolute maximum ratings	6
2.2	Thermal data	7
2.3	Electrical characteristics	7
3	Protection features	9
3.1	Electrical characteristics curves	12
4	Package and packing information	16
4.1	ECOPACK [®]	16
4.2	TO-251 (IPAK) mechanical data	16
4.3	TO-252 (DPAK) mechanical data	17
4.4	SOT-223 mechanical data	18
4.5	SO-8 mechanical data	19
4.6	SOT-223 packing information	21
4.7	SO-8 packing information	22
4.8	DPAK packing information	23
4.9	IPAK packing information	24
5	Revision history	25

List of tables

Table 1.	Device summary	1
Table 2.	Absolute maximum ratings	6
Table 3.	Thermal data	7
Table 4.	Electrical characteristics	7
Table 5.	TO-251 (IPAK) mechanical data	16
Table 6.	TO-252 (DPAK) mechanical data	17
Table 7.	SOT-223 mechanical data	18
Table 8.	SO-8 mechanical data	19
Table 9.	Document revision history	25

List of figures

Figure 1.	Block diagram	5
Figure 2.	Configuration diagram (top view)	5
Figure 3.	Current and voltage conventions	6
Figure 4.	Switching time test circuit for resistive load	10
Figure 5.	Test circuit for diode recovery times	10
Figure 6.	Unclamped inductive load test circuits	11
Figure 7.	Input charge test circuit.	11
Figure 8.	Unclamped inductive waveforms	11
Figure 9.	Thermal impedance for DPAK/IPAK.	12
Figure 10.	Thermal impedance for SOT-223	12
Figure 11.	Derating curve	12
Figure 12.	Transconductance	12
Figure 13.	Static drain-source on resistance vs input voltage (part 1/2)	12
Figure 14.	Static drain-source on resistance vs input voltage (part 2/2)	12
Figure 15.	Source-drain diode forward characteristics	13
Figure 16.	Static drain source on resistance	13
Figure 17.	Turn-on current slope (part 1/2)	13
Figure 18.	Turn-on current slope (part 2/2)	13
Figure 19.	Transfer characteristics	13
Figure 20.	Static drain-source on resistance vs I_d	13
Figure 21.	Input voltage vs input charge	14
Figure 22.	Turn-off drain source voltage slope (part 1/2).	14
Figure 23.	Turn-off drain source voltage slope (part 2/2).	14
Figure 24.	Capacitance variations	14
Figure 25.	Output characteristics	14
Figure 26.	Normalized on resistance vs temperature	14
Figure 27.	Switching time resistive load (part 1/2)	15
Figure 28.	Switching time resistive load (part 2/2)	15
Figure 29.	Normalized input threshold voltage vs temperature	15
Figure 30.	Normalized current limit vs junction temperature	15
Figure 31.	Step response current limit.	15
Figure 32.	TO-251 (IPAK) package dimensions	17
Figure 33.	TO-252 (DPAK) package dimensions.	18
Figure 34.	SOT-223 package dimensions	19
Figure 35.	SO-8 package dimensions	20
Figure 36.	SOT-223 tape and reel shipment (suffix "TR")	21
Figure 37.	SO-8 tube shipment (no suffix)	22
Figure 38.	SO-8 tape and reel shipment (suffix "TR")	22
Figure 39.	DPAK footprint and tube shipment (no suffix).	23
Figure 40.	DPAK tape and reel shipment (suffix "TR")	23
Figure 41.	IPAK tube shipment (no suffix)	24

1 Block diagram and pin description

Figure 1. Block diagram

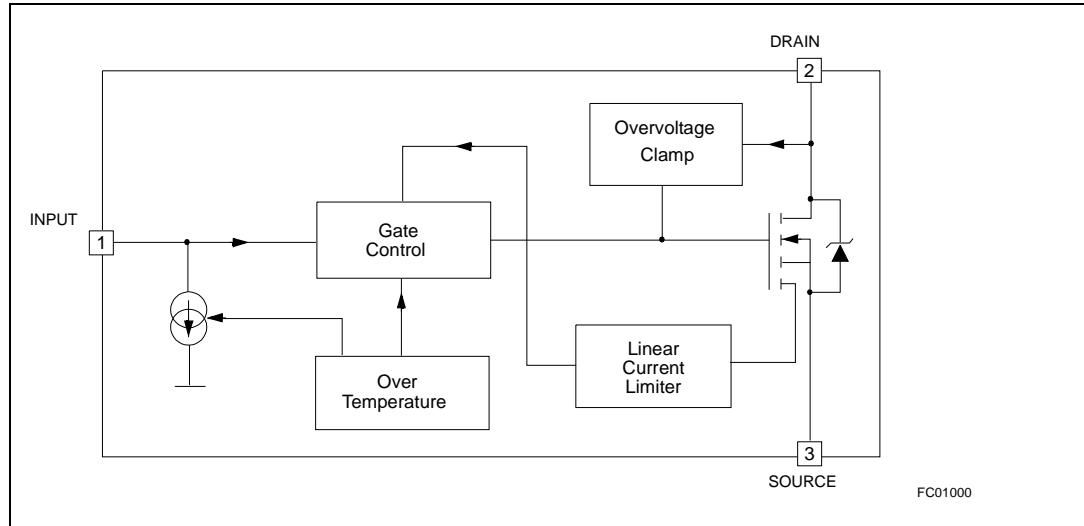
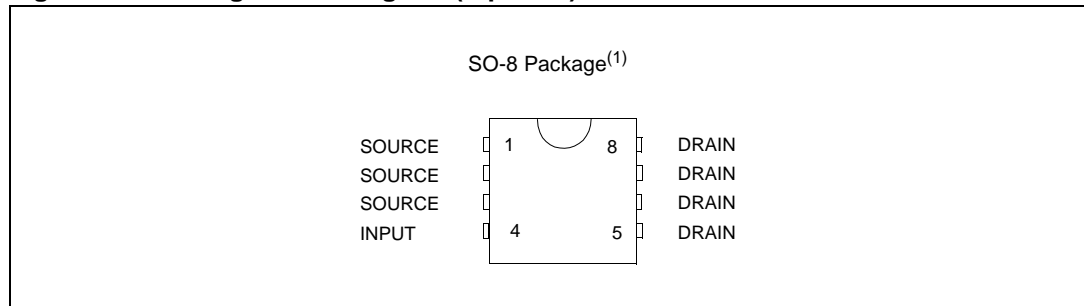

Figure 2. Configuration diagram (top view)



1. For the pins configuration related to SOT-223, DPAK, IPAK see outlines at page 1.

2 Electrical specifications

Figure 3. Current and voltage conventions



2.1 Absolute maximum ratings

Table 2. Absolute maximum ratings

Symbol	Parameter	Value			Unit
		SOT-223	SO-8	DPAK/IPAK	
V_{DS}	Drain-source voltage ($V_{IN}=0$ V)	Internally clamped			V
V_{IN}	Input voltage	Internally clamped			V
I_{IN}	Input current	+/-20			mA
$R_{IN\ MIN}$	Minimum input series impedance	220			Ω
I_D	Drain current	Internally limited			A
I_R	Reverse DC output current	-5.5			A
V_{ESD1}	Electrostatic discharge (R=1.5 K Ω , C=100 pF)	4000			V
V_{ESD2}	Electrostatic discharge on output pin only (R=330 Ω , C=150 pF)	16500			V
P_{tot}	Total dissipation at $T_c=25$ °C	7	8.3	35	W
T_j	Operating junction temperature	Internally limited			°C
T_c	Case operating temperature	Internally limited			°C
T_{stg}	Storage temperature	-55 to 150			°C

2.2 Thermal data

Table 3. Thermal data

Symbol	Parameter	Value				Unit
		SOT-223	SO-8	DPAK	IPAK	
$R_{thj-case}$	Thermal resistance junction-case max	18		3.5	3.5	°C/W
$R_{thj-lead}$	Thermal resistance junction-lead max		15			°C/W
$R_{thj-amb}$	Thermal resistance junction-ambient max	70 ⁽¹⁾	65 ⁽¹⁾	54 ⁽¹⁾	100	°C/W

1. When mounted on a standard single-sided FR4 board with 50 mm² of Cu (at least 35 mm thick) connected to all DRAIN pins.

2.3 Electrical characteristics

-40 °C < T_j < 150 °C, unless otherwise specified.

Table 4. Electrical characteristics

Symbol	Parameter	Test conditions	Min	Typ	Max	Unit
Off						
V_{CLAMP}	Drain-source clamp voltage	$V_{IN}=0$ V; $I_D=1.5$ A	40	45	55	V
V_{CLTH}	Drain-source clamp threshold voltage	$V_{IN}=0$ V; $I_D=2$ mA	36			V
V_{INTH}	Input threshold voltage	$V_{DS}=V_{IN}$; $I_D=1$ mA	0.5		2.5	V
I_{ISS}	Supply current from input pin	$V_{DS}=0$ V; $V_{IN}=5$ V		100	150	μA
V_{INCL}	Input-source clamp voltage	$I_{IN}=1$ mA $I_{IN}=-1$ mA	6 -1.0	6.8	8 -0.3	V
I_{DSS}	Zero input voltage drain current ($V_{IN}=0$ V)	$V_{DS}=13$ V; $V_{IN}=0$ V; $T_j=25$ °C $V_{DS}=25$ V; $V_{IN}=0$ V			30 75	μA
On						
$R_{DS(on)}$	Static drain-source on resistance	$V_{IN}=5$ V; $I_D=1.5$ A; $T_j=25$ °C $V_{IN}=5$ V; $I_D=1.5$ A			120 240	mΩ
Dynamic ($T_j=25$ °C, unless otherwise specified)						
$g_{fs}^{(1)}$	Forward transconductance	$V_{DD}=13$ V; $I_D=1.5$ A		5.0		S
C_{OSS}	Output capacitance	$V_{DS}=13$ V; $f=1$ MHz; $V_{IN}=0$ V		150		pF
Switching ($T_j=25$ °C, unless otherwise specified)						

Table 4. Electrical characteristics (continued)

Symbol	Parameter	Test conditions	Min	Typ	Max	Unit
$t_{d(on)}$	Turn-on delay time	$V_{DD}=15\text{ V}; I_D=1.5\text{ A}$ $V_{gen}=5\text{ V}; R_{gen}=R_{IN\text{ MIN}}=220\ \Omega$ (see figure Figure 4.)		90	300	ns
t_r	Rise time			250	750	ns
$t_{d(off)}$	Turn-off delay time			450	1350	ns
t_f	Fall time			250	750	ns
$t_{d(on)}$	Turn-on delay time	$V_{DD}=15\text{ V}; I_D=1.5\text{ A}$ $V_{gen}=5\text{ V}; R_{gen}=2.2\text{ K}\Omega$ (see figure Figure 4.)		0.45	1.35	μs
t_r	Rise time			2.5	7.5	μs
$t_{d(off)}$	Turn-off delay time			3.3	10.0	μs
t_f	Fall time			2.0	6.0	μs
$(dl/dt)_{on}$	Turn-on current slope	$V_{DD}=15\text{ V}; I_D=1.5\text{ A}$ $V_{gen}=5\text{ V}; R_{gen}=R_{IN\text{ MIN}}=220\ \Omega$		4.7		$\text{A}/\mu\text{s}$
Q_i	Total input charge	$V_{DD}=12\text{ V}; I_D=1.5\text{ A}; V_{IN}=5\text{ V}$ $I_{gen}=2.13\text{ mA}$ (see figure Figure 7.)		8.5		nC
Source drain diode ($T_j=25\text{ }^\circ\text{C}$, unless otherwise specified)						
$V_{SD}^{(1)}$	Forward on voltage	$I_{SD}=1.5\text{ A}; V_{IN}=0\text{ V}$		0.8		V
t_{rr}	Reverse recovery time	$I_{SD}=1.5\text{ A}; dl/dt=12\text{ A}/\mu\text{s}$		107		ns
Q_{rr}	Reverse recovery charge	$V_{DD}=30\text{ V}; L=200\ \mu\text{H}$		37		μC
I_{RRM}	Reverse recovery current	(see test circuit, figure Figure 5.)		0.7		A
Protections ($-40\text{ }^\circ\text{C} < T_j < 150\text{ }^\circ\text{C}$, unless otherwise specified)						
I_{lim}	Drain current limit	$V_{IN}=5\text{ V}; V_{DS}=13\text{ V}$	3.5	5	7	A
t_{dlim}	Step response current limit	$V_{IN}=5\text{ V}; V_{DS}=13\text{ V}$		10		μs
T_{jsh}	Over temperature shutdown		150	175	200	$^\circ\text{C}$
T_{jrs}	Over temperature reset		135			$^\circ\text{C}$
I_{gf}	Fault sink current	$V_{IN}=5\text{ V}; V_{DS}=13\text{ V}; T_j=T_{jsh}$	10	15	20	mA
E_{as}	Single pulse avalanche energy	starting $T_j=25\mu^\circ\text{C}$; $V_{DD}=24\text{ V}$ $V_{IN}=5\text{ V}; R_{gen}=R_{IN\text{ MIN}}=220\ \Omega; L=24\text{ mH}$ (see figures Figure 6. & Figure 8.)	100			mJ

1. Pulsed: Pulse duration = 300 μs , duty cycle 1.5 %

3 Protection features

During normal operation, the input pin is electrically connected to the gate of the internal Power MOSFET through a low impedance path.

The device then behaves like a standard Power MOSFET and can be used as a switch from DC up to 50 kHz. The only difference from the user's standpoint is that a small DC current I_{SS} (typ. 100 μ A) flows into the input pin in order to supply the internal circuitry.

The device integrates:

- Overvoltage clamp protection: internally set at 45 V, along with the rugged avalanche characteristics of the Power MOSFET stage give this device unrivalled ruggedness and energy handling capability. This feature is mainly important when driving inductive loads.
- Linear current limiter circuit: limits the drain current I_D to I_{lim} whatever the input pin voltages. When the current limiter is active, the device operates in the linear region, so power dissipation may exceed the capability of the heatsink. Both case and junction temperatures increase, and if this phase lasts long enough, junction temperature may reach the over temperature threshold T_{jsh} .
- Over temperature and short circuit protection: these are based on sensing the chip temperature and are not dependent on the input voltage. The location of the sensing element on the chip in the power stage area ensures fast, accurate detection of the junction temperature. Over temperature cutout occurs in the range 150 to 190 °C, a typical value being 170 °C. The device is automatically restarted when the chip temperature falls of about 15 °C below shutdown temperature.
- Status feedback: in the case of an over temperature fault condition ($T_j > T_{jsh}$), the device tries to sink a diagnostic current I_{gf} through the input pin in order to indicate fault condition. If driven from a low impedance source, this current may be used in order to warn the control circuit of a device shutdown. If the drive impedance is high enough so that the input pin driver is not able to supply the current I_{gf} , the input pin will fall to 0 V. This will not however affect the device operation: no requirement is put on the current capability of the input pin driver except to be able to supply the normal operation drive current I_{SS} .

Additional features of this device are ESD protection according to the Human Body model and the ability to be driven from a TTL logic circuit.

Figure 4. Switching time test circuit for resistive load

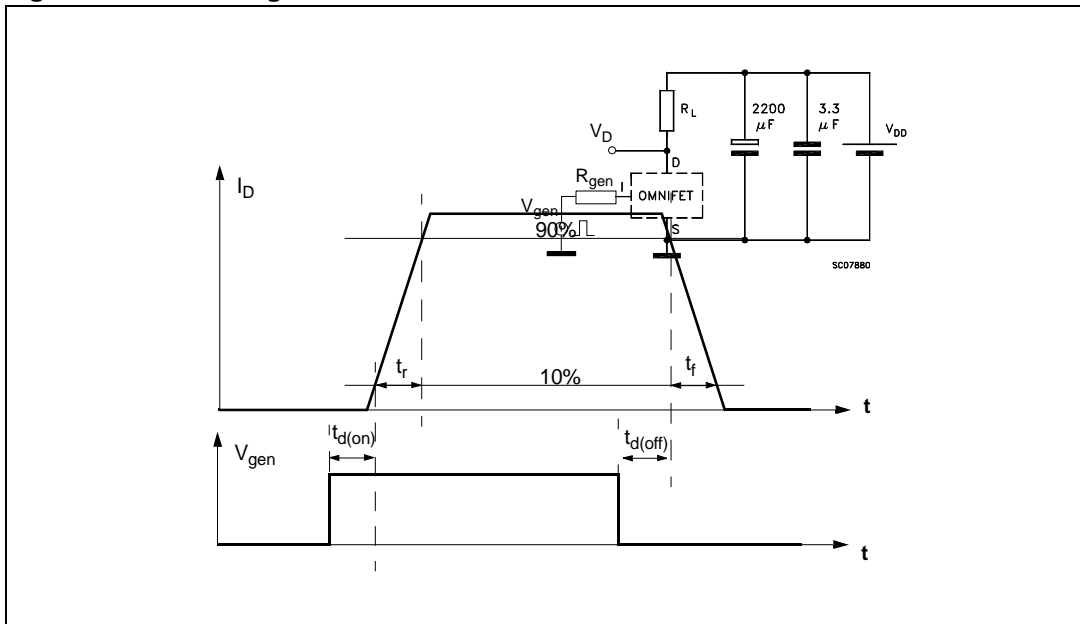

Figure 5. Test circuit for diode recovery times

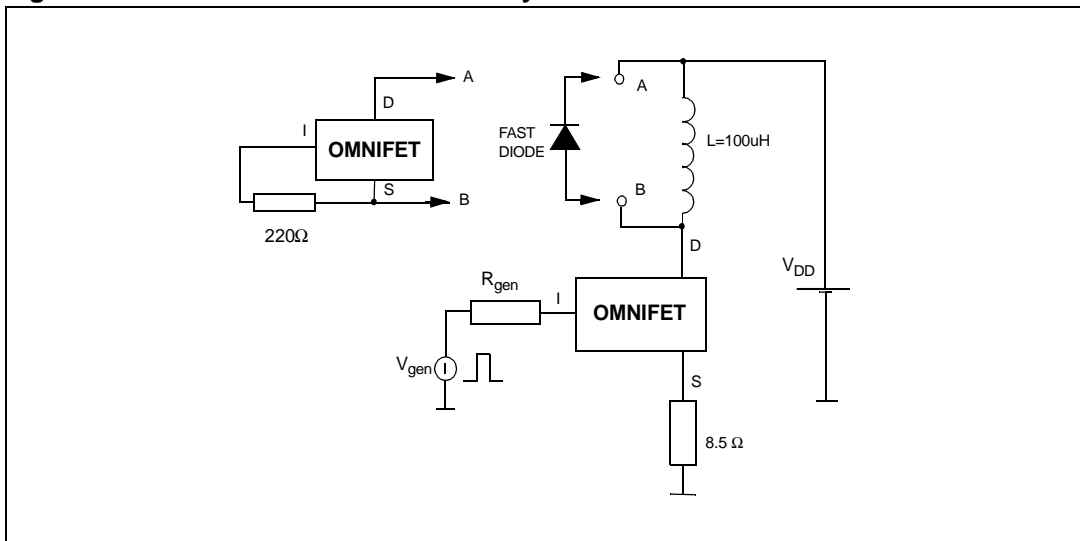

Figure 6. Unclamped inductive load test circuits



Figure 7. Input charge test circuit

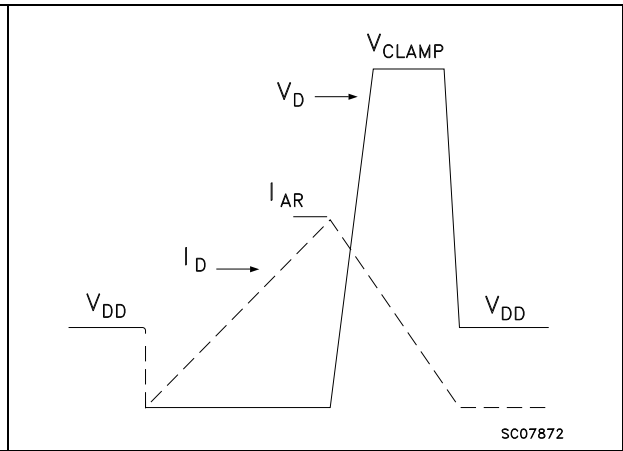

Figure 8. Unclamped inductive waveforms



3.1 Electrical characteristics curves

Figure 9. Thermal impedance for DPAK/IPAK Figure 10. Thermal impedance for SOT-223

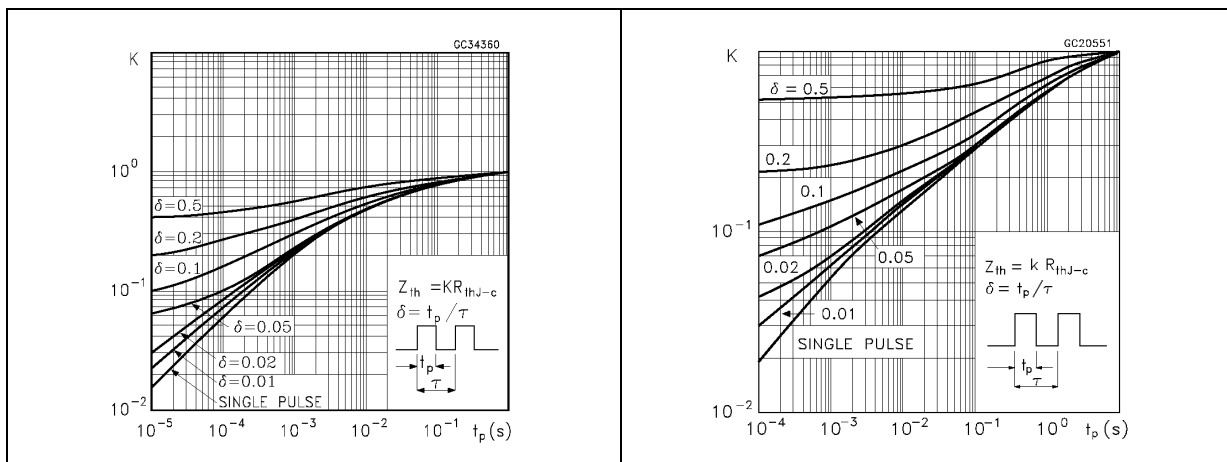

Figure 11. Derating curve

Figure 12. Transconductance

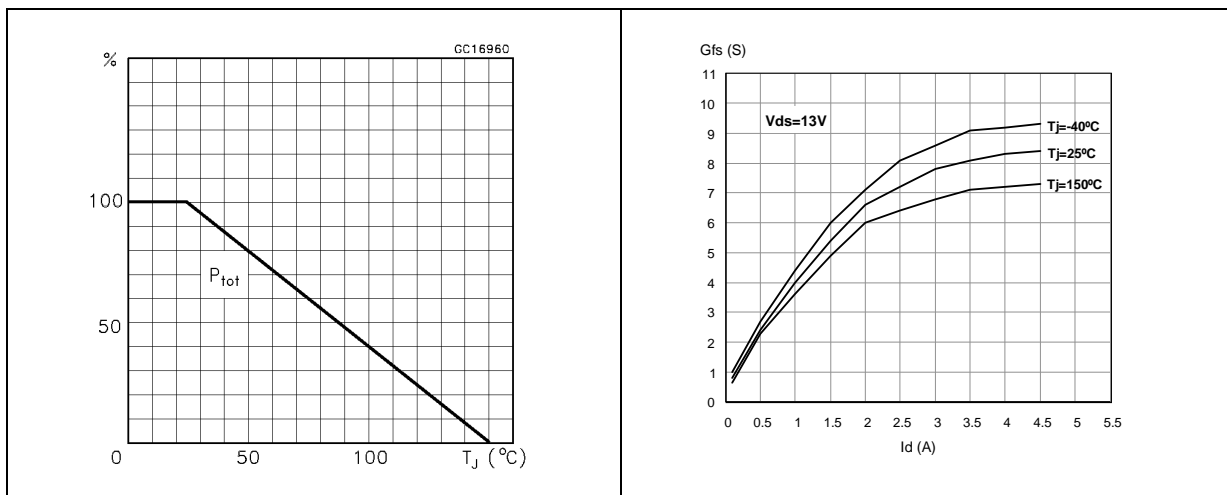

Figure 13. Static drain-source on resistance vs input voltage (part 1/2)

Figure 14. Static drain-source on resistance vs input voltage (part 2/2)

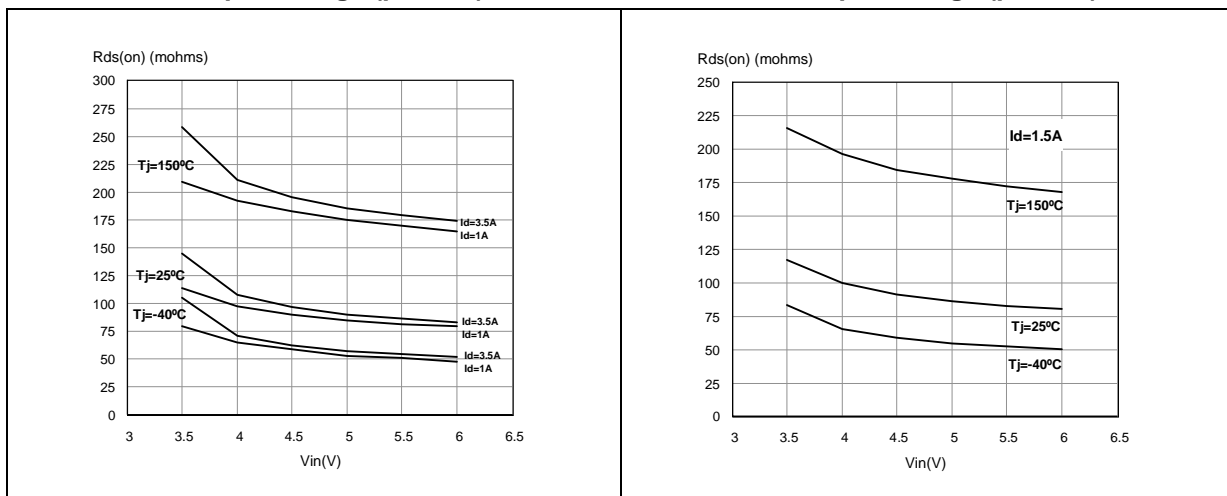

Figure 15. Source-drain diode forward characteristics

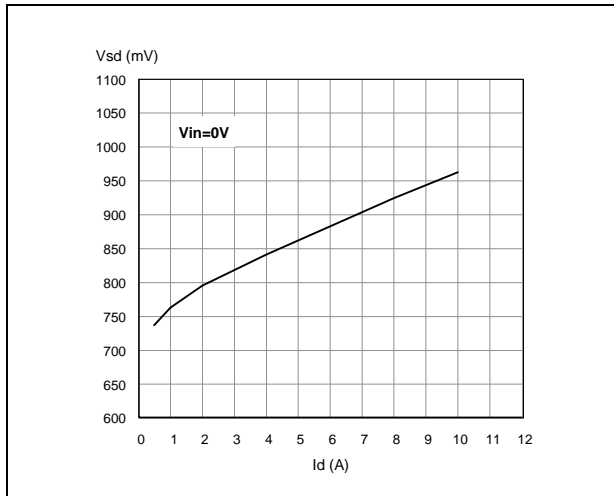

Figure 16. Static drain source on resistance

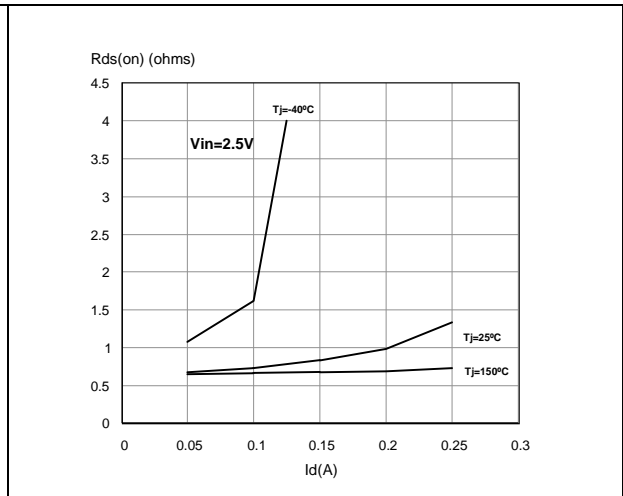

Figure 17. Turn-on current slope (part 1/2)

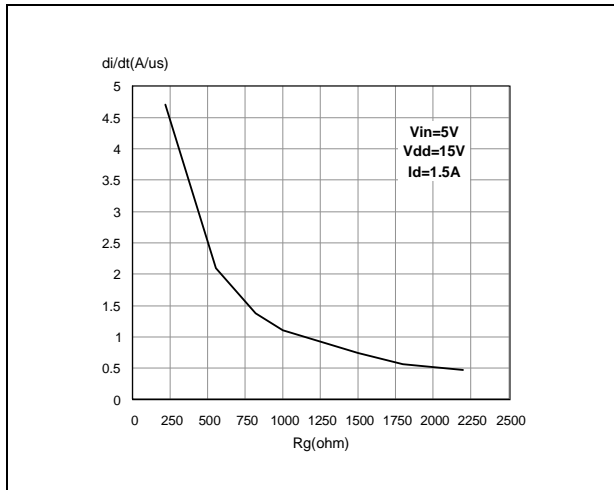

Figure 18. Turn-on current slope (part 2/2)

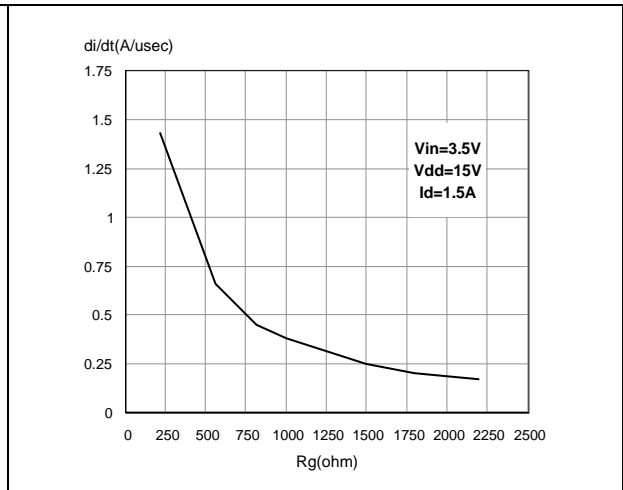

Figure 19. Transfer characteristics

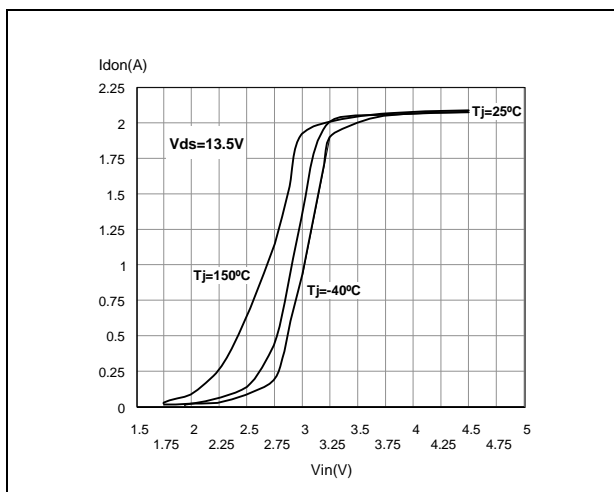

Figure 20. Static drain-source on resistance vs Id

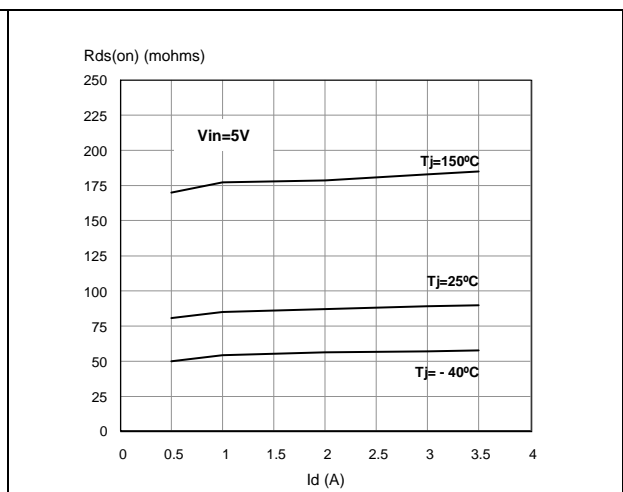

Figure 21. Input voltage vs input charge

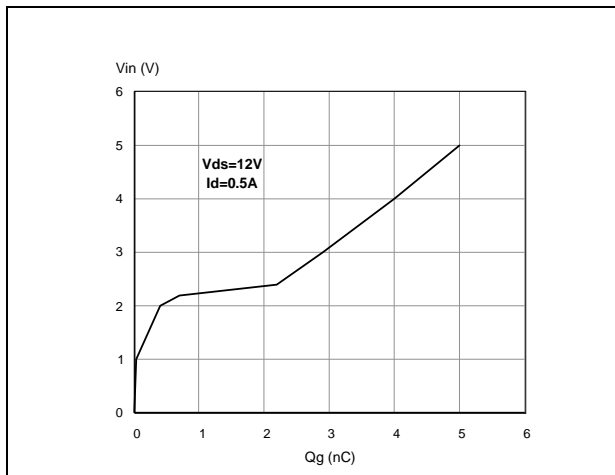

Figure 22. Turn-off drain source voltage slope (part 1/2)

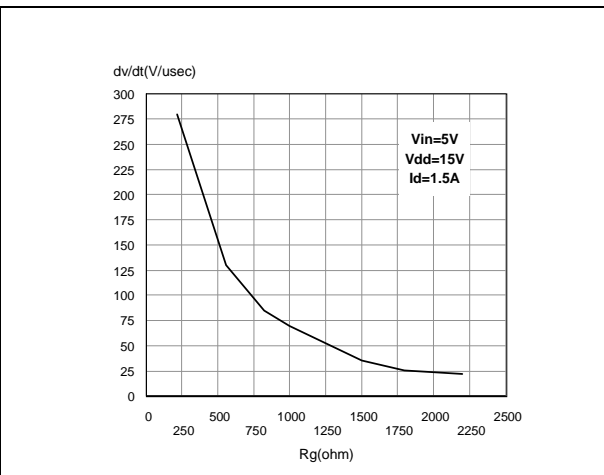

Figure 23. Turn-off drain source voltage slope (part 2/2)

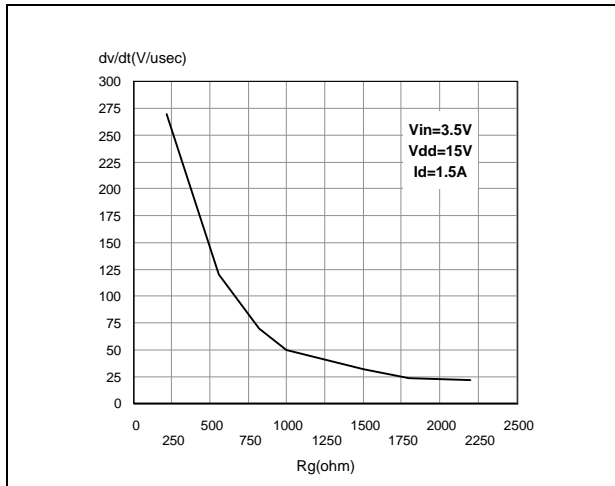

Figure 24. Capacitance variations

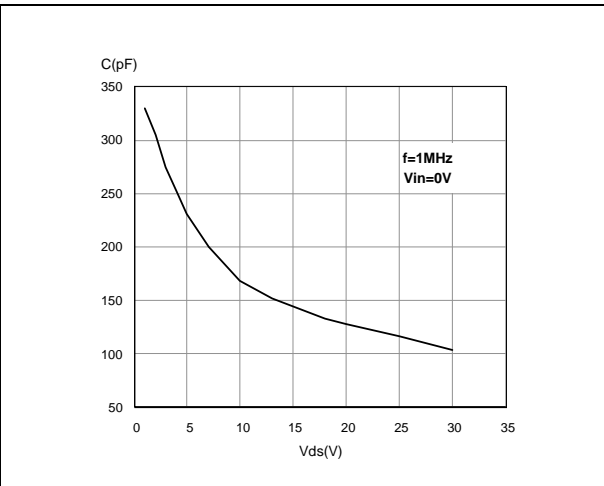

Figure 25. Output characteristics

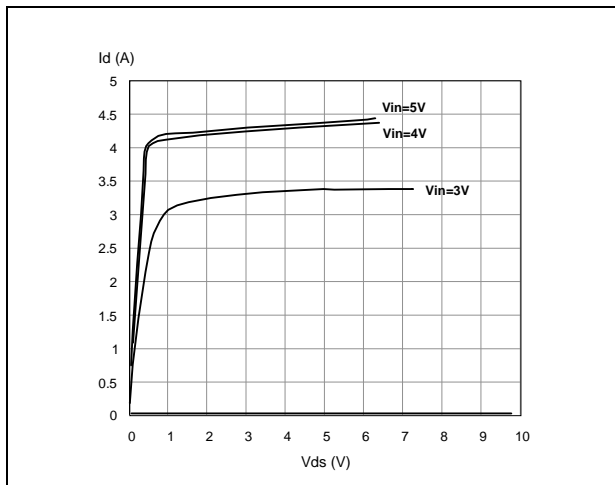

Figure 26. Normalized on resistance vs temperature

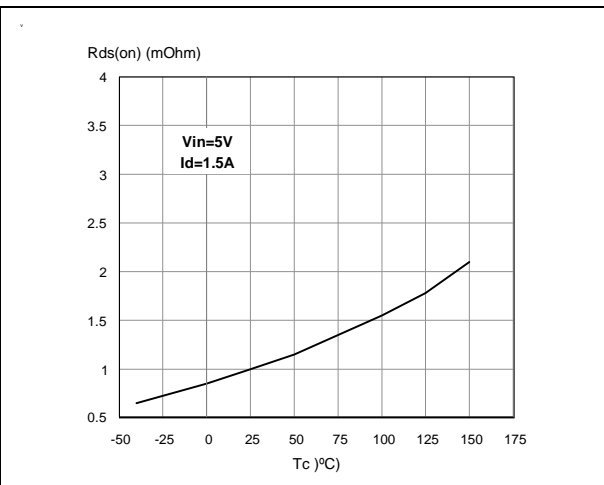

Figure 27. Switching time resistive load (part 1/2)

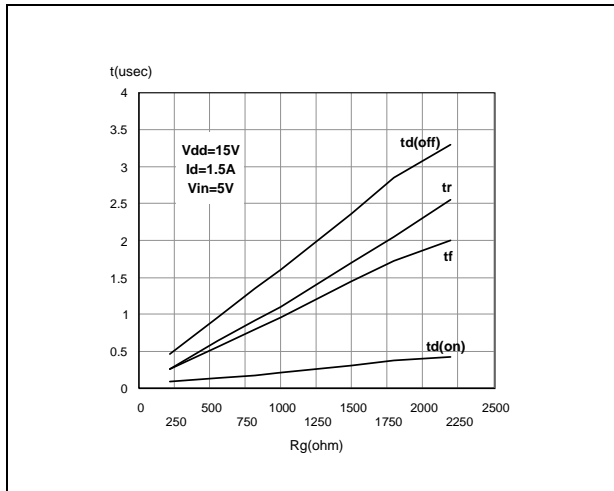

Figure 28. Switching time resistive load (part 2/2)

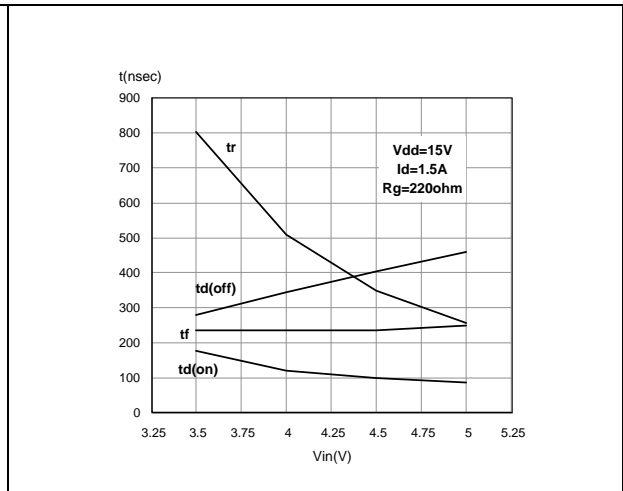

Figure 29. Normalized input threshold voltage vs temperature

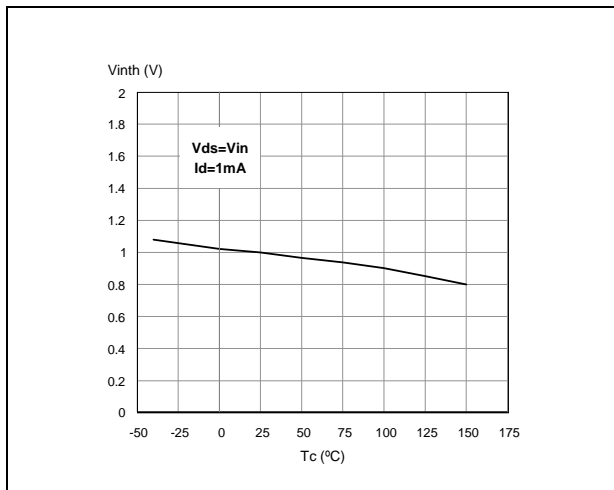

Figure 30. Normalized current limit vs junction temperature

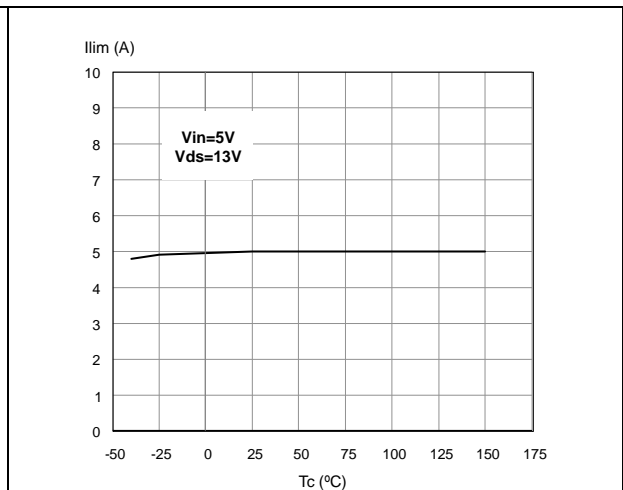
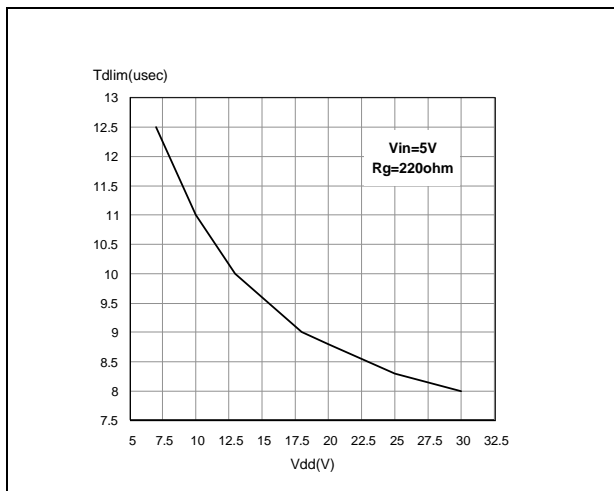

Figure 31. Step response current limit



4 Package and packing information

4.1 ECOPACK®

In order to meet environmental requirements, ST offers these devices in different grades of ECOPACK® packages, depending on their level of environmental compliance. ECOPACK® specifications, grade definitions and product status are available at: www.st.com.

ECOPACK® is an ST trademark.

4.2 TO-251 (IPAK) mechanical data

Table 5. TO-251 (IPAK) mechanical data

Symbol	millimeters		
	Min.	Typ.	Max.
A	2.2		2.4
A1	0.9		1.1
A3	0.7		1.3
B	0.64		0.9
B2	5.2		5.4
B3			0.85
B5		0.3	
B6			0.95
C	0.45		0.6
C2	0.48		0.6
D	6		6.2
E	6.4		6.6
G	4.4		4.6
H	15.9		16.3
L	9		9.4
L1	0.8		1.2
L2		0.8	1

Figure 32. TO-251 (IPAK) package dimensions

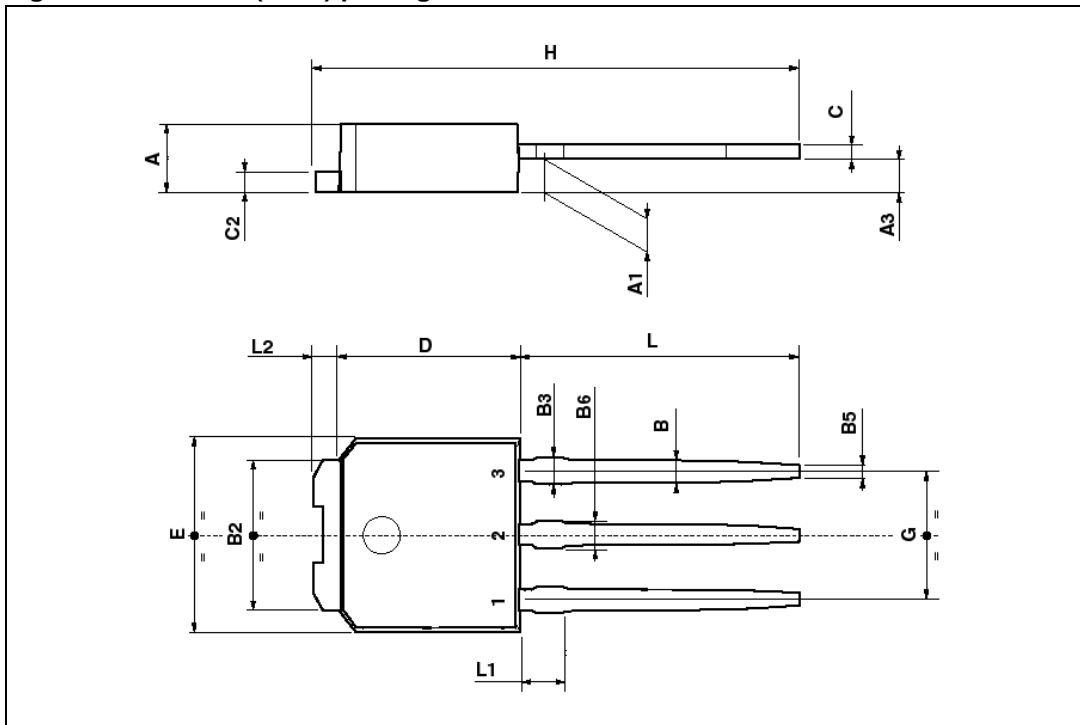

4.3 TO-252 (DPAK) mechanical data

Table 6. TO-252 (DPAK) mechanical data

Symbol	millimeters		
	Min.	Typ.	Max.
A	2.20		2.40
A1	0.90		1.10
A2	0.03		0.23
B	0.64		0.90
B2	5.20		5.40
C	0.45		0.60
C2	0.48		0.60
D	6.00		6.20
D1		5.1	
E	6.40		6.60
E1		4.7	
e		2.28	
G	4.40		4.60
H	9.35		10.10

Table 6. TO-252 (DPAK) mechanical data (continued)

Symbol	millimeters		
	Min.	Typ.	Max.
L2		0.8	
L4	0.60		1.00
R		0.2	
V2	0°	8°	
Package Weight	Gr. 0.29		

Figure 33. TO-252 (DPAK) package dimensions

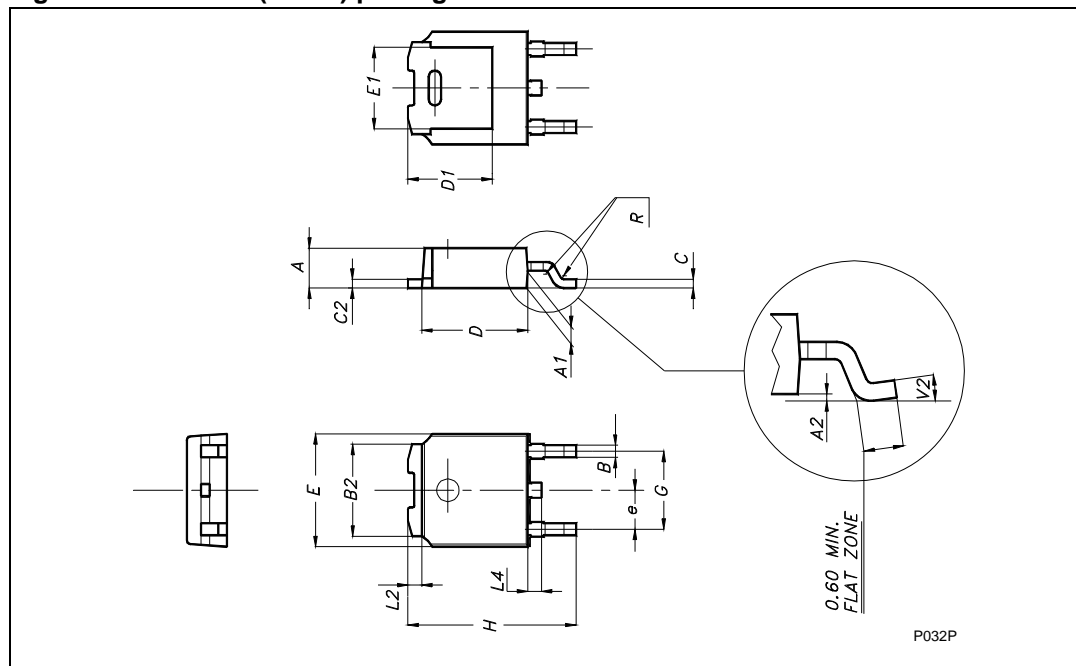

4.4 SOT-223 mechanical data

Table 7. SOT-223 mechanical data

Symbol	millimeters		
	Min.	Typ.	Max.
A			1.8
B	0.6	0.7	0.85
B1	2.9	3	3.15
c	0.24	0.26	0.35
D	6.3	6.5	6.7
e		2.3	

Table 7. SOT-223 mechanical data (continued)

Symbol	millimeters		
	Min.	Typ.	Max.
e1		4.6	
E	3.3	3.5	3.7
H	6.7	7	7.3
V	10 (max)		
A1	0.02		0.1

Figure 34. SOT-223 package dimensions

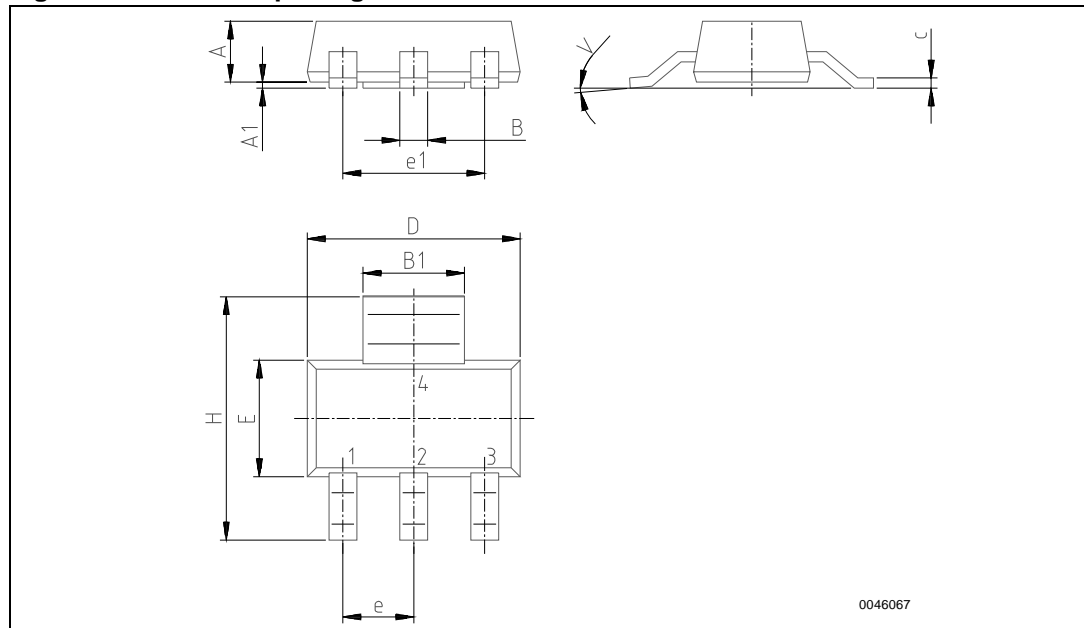

4.5 SO-8 mechanical data

Table 8. SO-8 mechanical data

Symbol	millimeters		
	Min	Typ	Max
A			1.75
a1	0.1		0.25
a2			1.65
a3	0.65		0.85
b	0.35		0.48
A			1.75
A1	0.10		0.25

Table 8. SO-8 mechanical data (continued)

Symbol	millimeters		
	Min	Typ	Max
A2	1.25		
b	0.28		0.48
c	0.17		0.23
D ⁽¹⁾	4.80	4.90	5.00
E	5.80	6.00	6.20
E1 ⁽²⁾	3.80	3.90	4.00
e		1.27	
h	0.25		0.50
L	0.40		1.27
L1		1.04	
k	0°		8°
ccc			0.10

1. Dimension "D" does not include mold flash, protrusions or gate burrs. Mold flash, protrusions or gate burrs shall not exceed 0.15 mm in total (both side).
2. Dimension "E1" does not include interlead flash or protrusions. Interlead flash or protrusions shall not exceed 0.25 mm per side.

Figure 35. SO-8 package dimensions

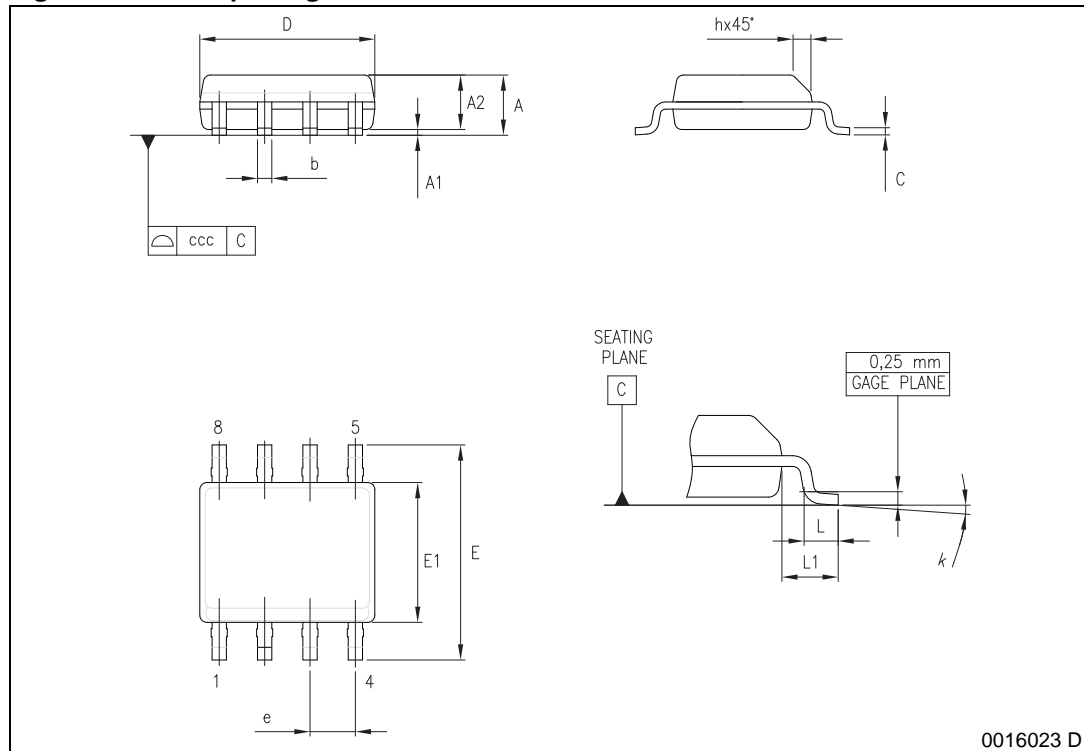

0016023 D

4.6 SOT-223 packing information

Figure 36. SOT-223 tape and reel shipment (suffix "TR")

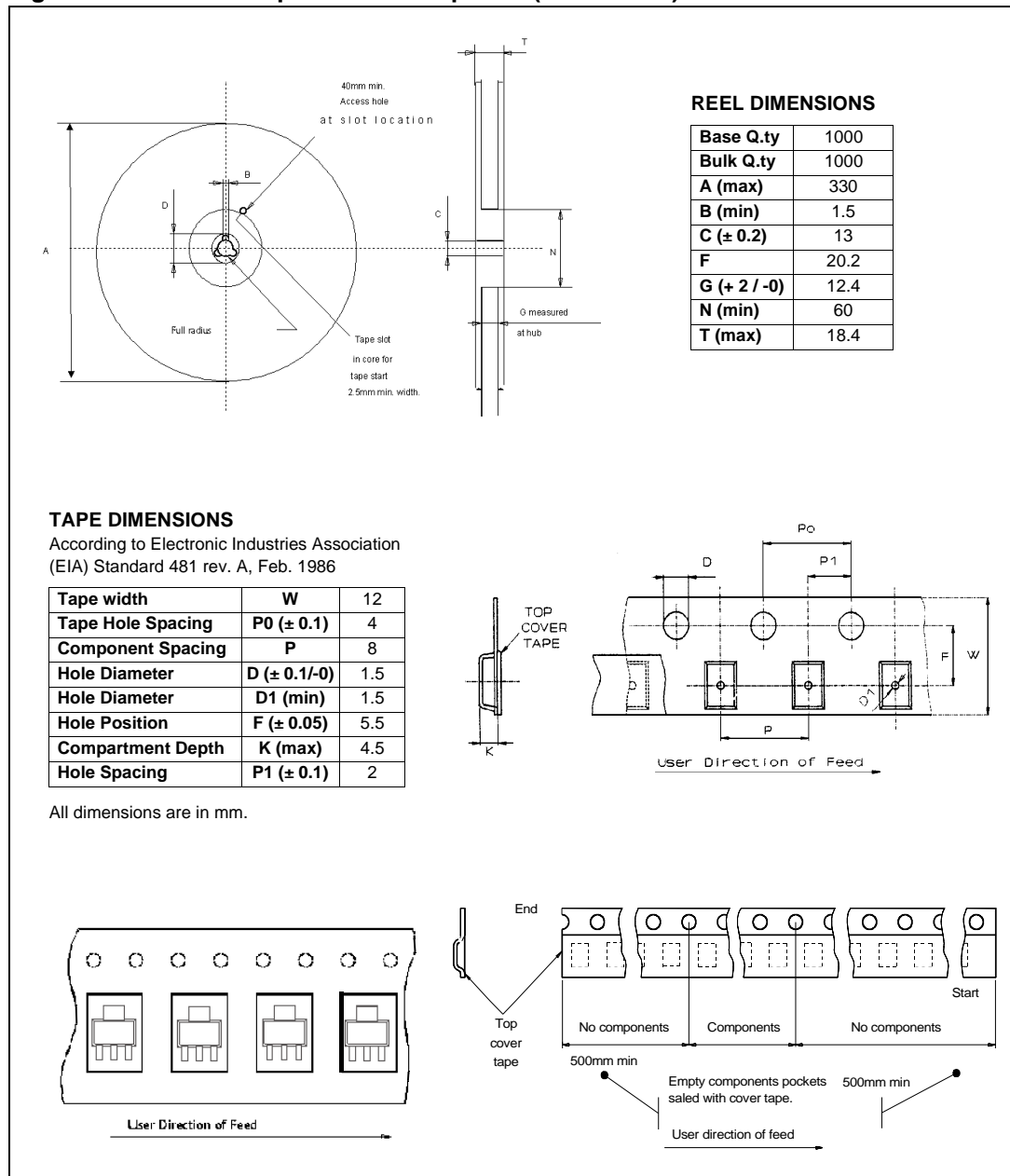

4.7 SO-8 packing information

Figure 37. SO-8 tube shipment (no suffix)

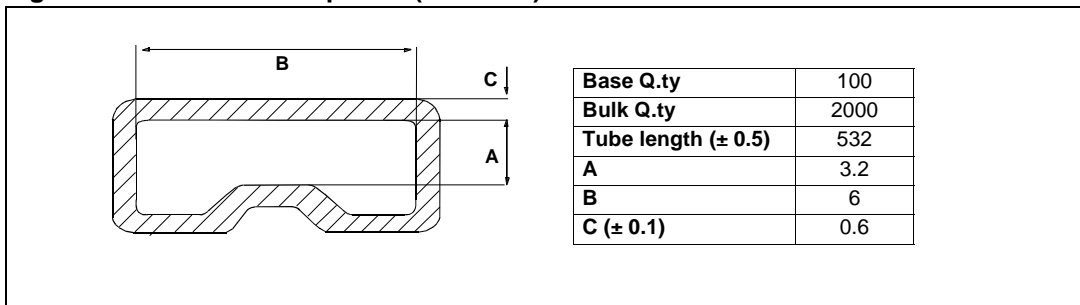
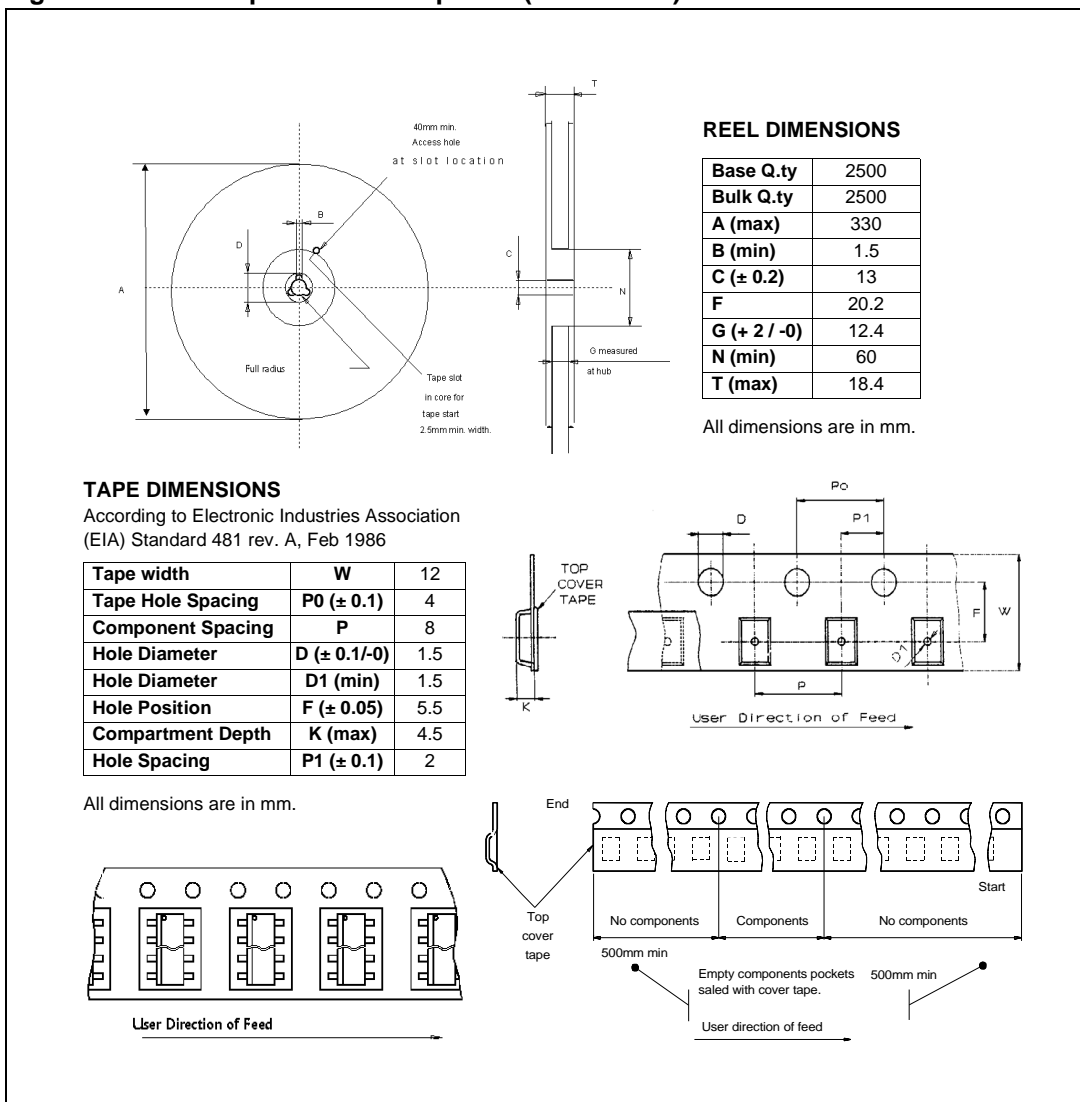

Figure 38. SO-8 tape and reel shipment (suffix "TR")



4.8 DPAK packing information

Figure 39. DPAK footprint and tube shipment (no suffix)

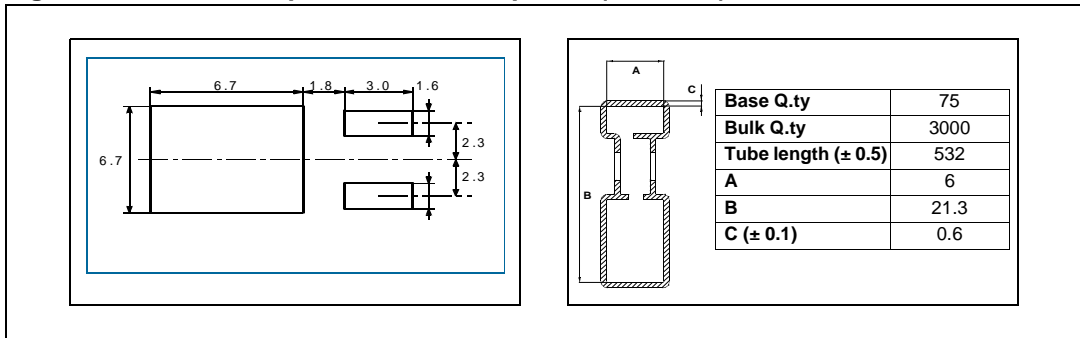
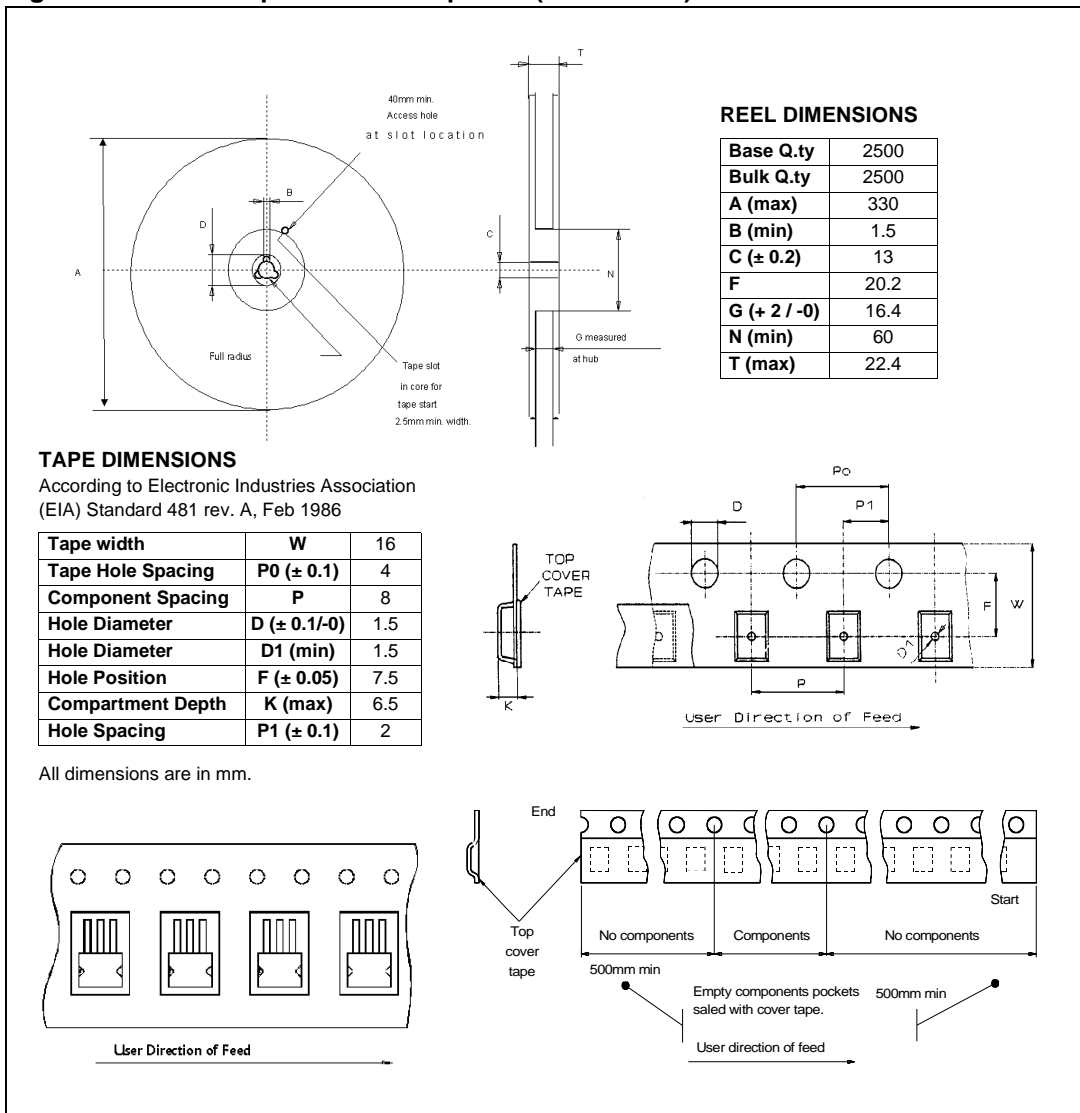
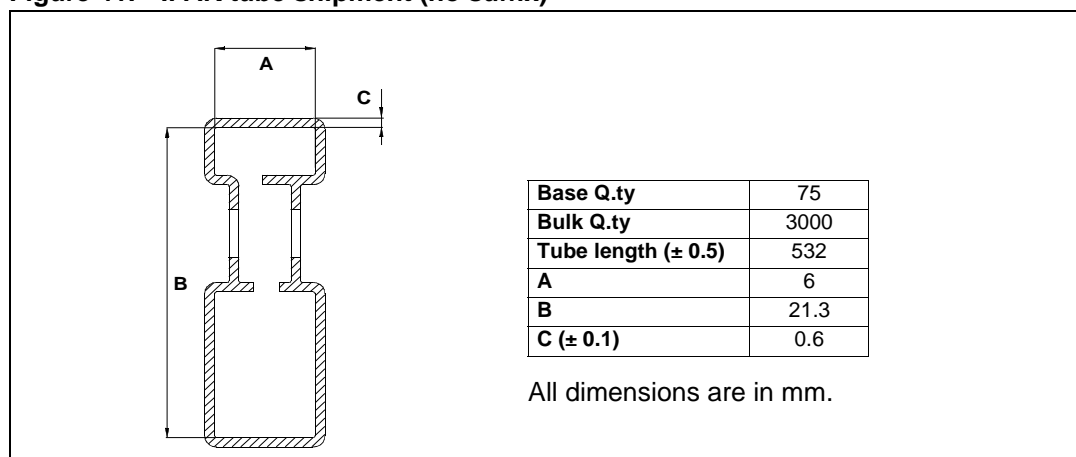

Figure 40. DPAK tape and reel shipment (suffix "TR")



4.9 IPAK packing information

Figure 41. IPAK tube shipment (no suffix)



5 Revision history

Table 9. Document revision history

Date	Revision	Changes
01-Feb-2003	1	Initial Release
27-Apr-2009	2	Added Table 1: Device summary on page 1 Updated Table 4: Package and packing information on page 16
05-Apr-2011	3	Table 2: Absolute maximum ratings: – R _{IN MIN} : changed unit from W to Ω Inserted Section 4.1: ECOPACK®
20-Sep-2013	4	Updated Disclaimer.

Please Read Carefully:

Information in this document is provided solely in connection with ST products. STMicroelectronics NV and its subsidiaries ("ST") reserve the right to make changes, corrections, modifications or improvements, to this document, and the products and services described herein at any time, without notice.

All ST products are sold pursuant to ST's terms and conditions of sale.

Purchasers are solely responsible for the choice, selection and use of the ST products and services described herein, and ST assumes no liability whatsoever relating to the choice, selection or use of the ST products and services described herein.

No license, express or implied, by estoppel or otherwise, to any intellectual property rights is granted under this document. If any part of this document refers to any third party products or services it shall not be deemed a license grant by ST for the use of such third party products or services, or any intellectual property contained therein or considered as a warranty covering the use in any manner whatsoever of such third party products or services or any intellectual property contained therein.

UNLESS OTHERWISE SET FORTH IN ST'S TERMS AND CONDITIONS OF SALE ST DISCLAIMS ANY EXPRESS OR IMPLIED WARRANTY WITH RESPECT TO THE USE AND/OR SALE OF ST PRODUCTS INCLUDING WITHOUT LIMITATION IMPLIED WARRANTIES OF MERCHANTABILITY, FITNESS FOR A PARTICULAR PURPOSE (AND THEIR EQUIVALENTS UNDER THE LAWS OF ANY JURISDICTION), OR INFRINGEMENT OF ANY PATENT, COPYRIGHT OR OTHER INTELLECTUAL PROPERTY RIGHT.

ST PRODUCTS ARE NOT DESIGNED OR AUTHORIZED FOR USE IN: (A) SAFETY CRITICAL APPLICATIONS SUCH AS LIFE SUPPORTING, ACTIVE IMPLANTED DEVICES OR SYSTEMS WITH PRODUCT FUNCTIONAL SAFETY REQUIREMENTS; (B) AERONAUTIC APPLICATIONS; (C) AUTOMOTIVE APPLICATIONS OR ENVIRONMENTS, AND/OR (D) AEROSPACE APPLICATIONS OR ENVIRONMENTS. WHERE ST PRODUCTS ARE NOT DESIGNED FOR SUCH USE, THE PURCHASER SHALL USE PRODUCTS AT PURCHASER'S SOLE RISK, EVEN IF ST HAS BEEN INFORMED IN WRITING OF SUCH USAGE, UNLESS A PRODUCT IS EXPRESSLY DESIGNATED BY ST AS BEING INTENDED FOR "AUTOMOTIVE, AUTOMOTIVE SAFETY OR MEDICAL" INDUSTRY DOMAINS ACCORDING TO ST PRODUCT DESIGN SPECIFICATIONS. PRODUCTS FORMALLY ESCC, QML OR JAN QUALIFIED ARE DEEMED SUITABLE FOR USE IN AEROSPACE BY THE CORRESPONDING GOVERNMENTAL AGENCY.

Resale of ST products with provisions different from the statements and/or technical features set forth in this document shall immediately void any warranty granted by ST for the ST product or service described herein and shall not create or extend in any manner whatsoever, any liability of ST.

ST and the ST logo are trademarks or registered trademarks of ST in various countries.

Information in this document supersedes and replaces all information previously supplied.

The ST logo is a registered trademark of STMicroelectronics. All other names are the property of their respective owners.

© 2013 STMicroelectronics - All rights reserved

STMicroelectronics group of companies

Australia - Belgium - Brazil - Canada - China - Czech Republic - Finland - France - Germany - Hong Kong - India - Israel - Italy - Japan - Malaysia - Malta - Morocco - Philippines - Singapore - Spain - Sweden - Switzerland - United Kingdom - United States of America

www.st.com