

- Internal TTL MSI IC with Latch, Decoder, and Driver
- 0.300-Inch (7,62-mm) Character Height
- Wide Viewing Angle
- High Brightness
- Left-and-Right-Hand Decimals
- Constant-Current Drive for Hexadecimal Characters
- Separate LED and Logic Power Supplies May Be Used
- Operates from 5-V Supply
- Easy System Interface

**PACKAGE P
14-LEAD PDIP
(BOTTOM VIEW)**

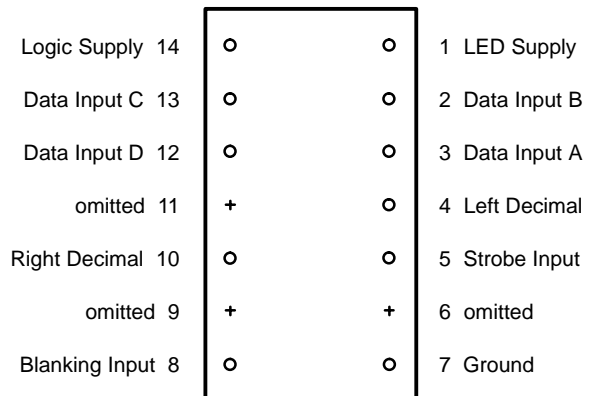

Description

The TIL311 is a single-digit LED hexadecimal display with internal four-bit latch, decoder, and constant-current LED drivers in a 14-pin dual-in-line-package. Hexadecimal characters are formed by a 4 × 7 array of red light-emitting-diodes that are illuminated in a modified seven-segment configuration. The device includes right-hand and left-hand externally driven decimal points.

Functional Block Diagram

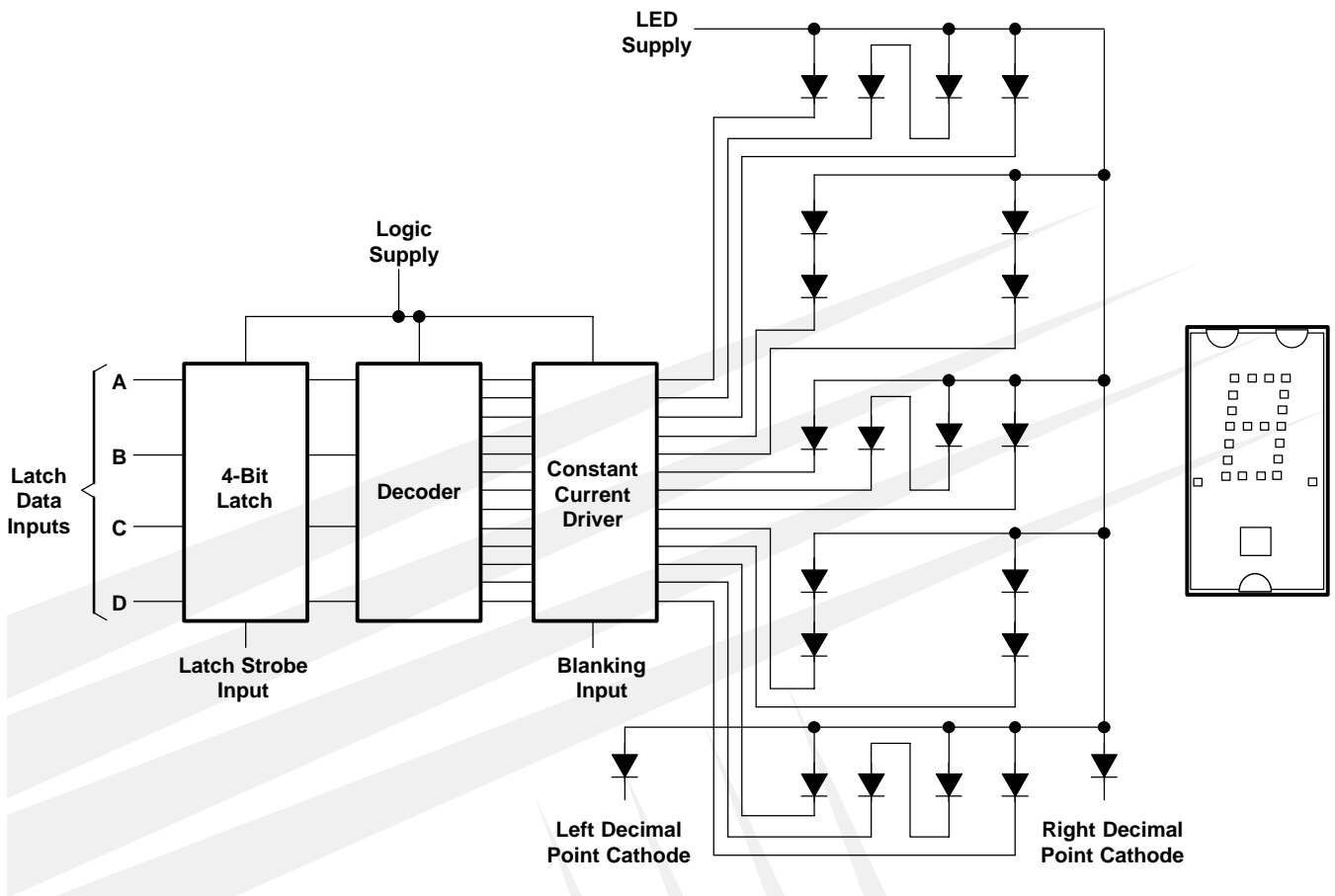

TIL311 HEXADECIMAL DISPLAY WITH LOGIC

TAOS058 – JANUARY 2004

Terminal Functions

| TERMINAL NAME | NO. | TYPE | DESCRIPTION |
|----------------|----------|------|---|
| Blanking Input | 8 | I | Blanking Input. When high, the display is blanked regardless of the levels of the other inputs. When low, a character is displayed as determined by the data in the latches. The blanking input may be pulsed for intensity modulation. |
| Data Input A | 3 | I | Latch Data Input A. Data on this input is entered into the latch when the Latch Strobe Input is low. The binary weight of this input is 1. |
| Data Input B | 2 | I | Latch Data Input B. Data on this input is entered into the latch when the Latch Strobe Input is low. The binary weight of this input is 2. |
| Data Input C | 13 | I | Latch Data Input C. Data on this input is entered into the latch when the Latch Strobe Input is low. The binary weight of this input is 4. |
| Data Input D | 12 | I | Latch Data Input D. Data on this input is entered into the latch when the Latch Strobe Input is low. The binary weight of this input is 8. |
| Ground | 7 | | Common Ground. This is the negative terminal for all logic and LED currents except for the decimal points. |
| LED Supply | 1 | | LED Supply (V_{CC}). This terminal permits the user to save on regulated V_{CC} current by using a separate LED supply, or it may be externally connected to the logic supply (V_{CC}). |
| Left Decimal | 4 | | Left Decimal Point Cathode. This LED is not connected to the logic chip. If a decimal point is used, an external resistor or other current-limiting mechanism must be connected in series with it. |
| Logic Supply | 14 | | Logic Supply (V_{CC}). Separate V_{CC} terminal for the logic chip. |
| omitted | 6, 9, 11 | | There is no pin at this location. |
| Right Decimal | 10 | | Right Decimal Point Cathode. This LED is not connected to the logic chip. If a decimal point is used, an external resistor or other current-limiting mechanism must be connected in series with it. |
| Strobe Input | 5 | I | Latch Strobe Input. When low, the data in the latches follow the data on the latch data inputs. When high, the data in the latches does not change. If the display is blanked and then restored while this input is high, the previously displayed character will again be displayed. |

Absolute Maximum Ratings over operating free-air temperature range (unless otherwise noted)†

| | |
|--|---------------|
| Supply voltage, logic, V_{CC} (see Note 1) | 7 V |
| Supply voltage, LED, V_{CC} (see Note 1) | 7 V |
| Input voltage (pins 2, 3, 5, 8, 12, 13), V_I | 5.5 V |
| Decimal point current | 20 mA |
| Operating case temperature range, T_C (see Note 2) | 0°C to 85°C |
| Storage temperature range, T_{stg} | -25°C to 85°C |

† Stresses beyond those listed under “absolute maximum ratings” may cause permanent damage to the device. These are stress ratings only, and functional operation of the device at these or any other conditions beyond those indicated under “recommended operating conditions” is not implied. Exposure to absolute-maximum-rated conditions for extended periods may affect device reliability.



NOTES: 1. All voltages are with respect to the Common Ground terminal.
2. Case temperature is the surface temperature of the plastic measured directly over the integrated circuit. Forced-air cooling may be required to maintain this temperature.

Recommended Operating Conditions

| | MIN | NOM | MAX | UNIT |
|--------------------------------------|-----|-----|-----|------|
| Supply voltage, logic, V_{CC} | 4.5 | 5 | 5.5 | V |
| Supply voltage, LED, V_{LED} | 4 | 5 | 5.5 | V |
| Decimal point current, $I_{F(DP)}$ | | 5 | | mA |
| Pulse duration, t_w , latch strobe | 40 | | | ns |
| Setup time, t_{su} | 50 | | | ns |
| Hold time, t_h | 40 | | | ns |

Electrical Characteristics at $T_A = 25^\circ\text{C}$

| PARAMETER | | TEST CONDITIONS | MIN | TYP | MAX | UNIT |
|-----------------|---------------------------------|--|-----|-----|------|----------------|
| I_V | Luminous intensity (see Note 3) | Average per character LED $V_{CC} = 5\text{ V}, V_{LED} = 5\text{ V},$ See Note 4 | 35 | 100 | | μcd |
| | | Each decimal $I_{F(DP)} = 5\text{ mA}$ | 35 | 100 | | μcd |
| λ_p | Wavelength at peak emission | $V_{CC} = 5\text{ V}, V_{LED} = 5\text{ V},$ $I_{F(DP)} = 5\text{ mA},$ See Note 5 | | 660 | | nm |
| $\Delta\lambda$ | Spectral bandwidth | | | 20 | | nm |
| V_{IH} | High-level input voltage | | 2 | | | V |
| V_{IL} | Low-level input voltage | | | | 0.8 | V |
| V_{IK} | Input clamp voltage | $V_{CC} = 4.75\text{ V}, I_I = -12\text{ mA}$ | | | -1.5 | V |
| I_I | Input current | $V_{CC} = 5.5\text{ V}, V_I = 5.5\text{ V}$ | | | 1 | mA |
| I_{IH} | High-level input current | $V_{CC} = 5.5\text{ V}, V_I = 2.4\text{ V}$ | | | 40 | μA |
| I_{IL} | Low-level input current | $V_{CC} = 5.5\text{ V}, V_I = 0.4\text{ V}$ | | | -1.6 | mA |
| I_{CC} | Supply current, logic | $V_{CC} = 5.5\text{ V}, V_{LED} = 5.5\text{ V},$ $I_{F(DP)} = 5\text{ mA},$ All inputs at 0 V | | 60 | 90 | mA |
| I_{LED} | Supply current, LED | | | 45 | 90 | mA |

- NOTES: 3. Luminous intensity is measured with a light sensor and filter combination that approximates the CIE (International Commission on Illumination) eye-response curve.
4. This parameter is measured with  displayed, then again with  displayed.
5. These parameters are measured with  displayed.

TYPICAL CHARACTERISTICS

RELATIVE SPECTRAL CHARACTERISTIC

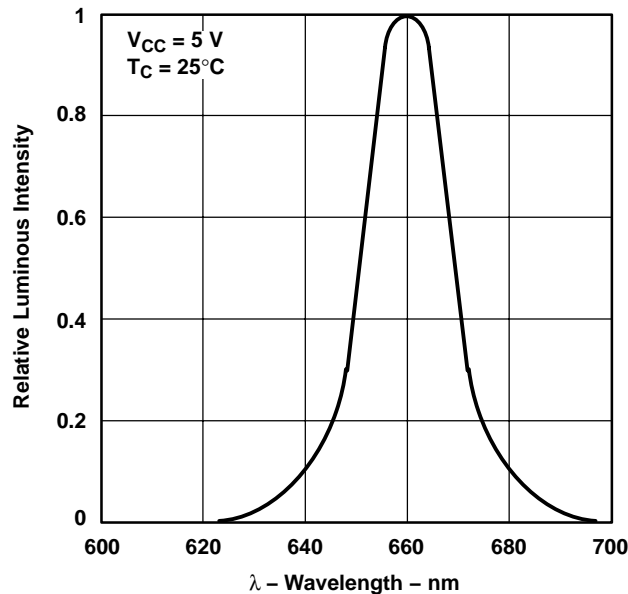

Figure 1

TYPICAL CHARACTERISTICS

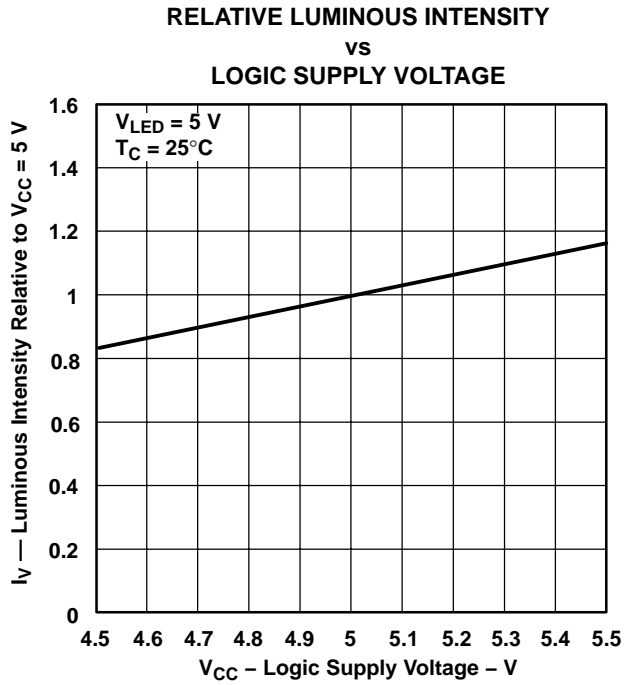

Figure 2

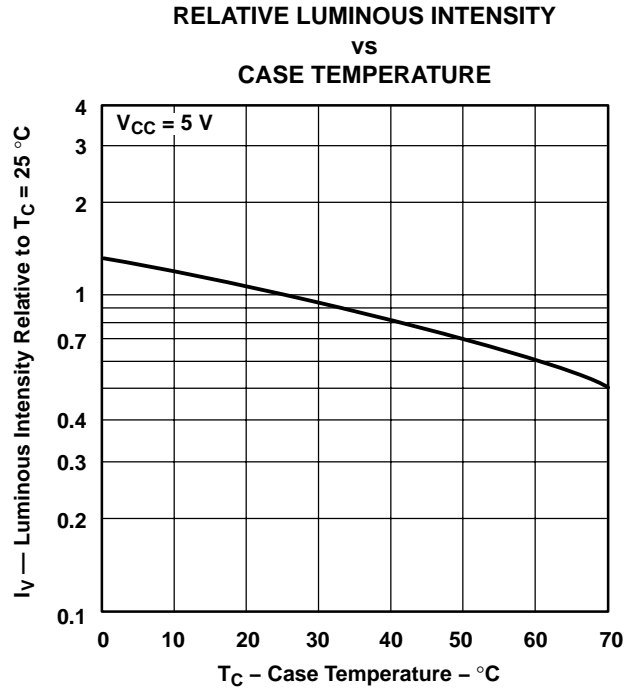

Figure 3

PRINCIPLES OF OPERATION

TTL-level four-bit binary data is applied to Latch Data Inputs A through D. As long as the Latch Strobe Input is low, latch output follows the input data. Latch output data is decoded and sent to the display LEDs to form the corresponding characters. When the Latch Strobe Input goes high, input data is stored in the latch and the display does not change.

The resulting character displays for the values of the binary data in the latch are shown in Figure 4.

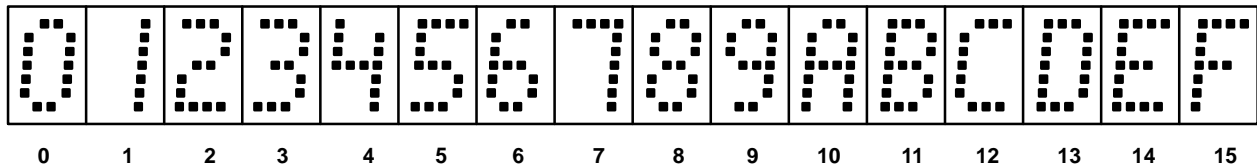

Figure 4. Display Character Configurations

While the Blanking Input is held low, the display shows the character corresponding to the data at the latch output. When the Blanking Input goes high, drive to the character display LEDs is removed and the display is blanked (except for the decimal points, which are independent and externally driven). Data in the latch and operation of the device logic elements are not affected by blanking the display. A repetitive variable-width pulse can be applied to the Blanking Input to adjust the apparent brightness of the display.

The LED driver outputs are designed to maintain a relatively constant on-level current of approximately 5 mA through each LED that forms the hexadecimal character. This current is virtually independent of the LED supply voltage within the recommended operating conditions. Drive current varies slightly with changes in the logic supply voltage, resulting in a change in luminous intensity as shown in Figure 2. This change is not noticeable to the eye.

The decimal point anodes are connected to the LED supply; the cathodes are connected to external pins. Since there is no current limiting built into the decimal point circuits, current limiting must be provided externally if the decimal points are used.

TIL311 HEXADECIMAL DISPLAY WITH LOGIC

TAOS058 – JANUARY 2004

MECHANICAL DATA

These assemblies consist of LED chips and a TTL MSI logic chip mounted on a header with a red molded plastic body. Multiple displays may be mounted on 0.450-inch (11,43-mm) centers.

PACKAGE P

PLASTIC DUAL-IN-LINE

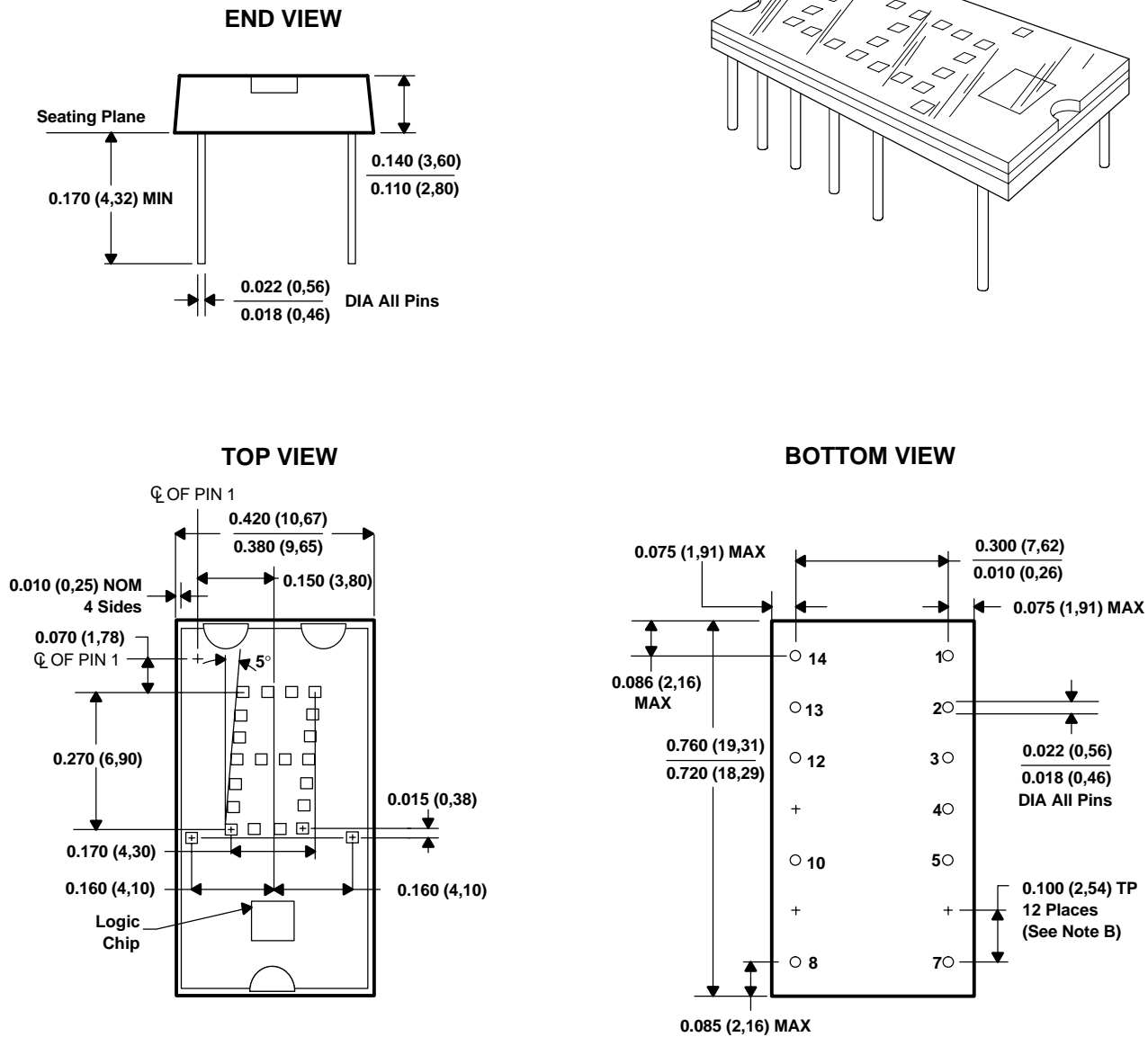

- NOTES: A. All linear dimensions are in inches and (parenthetically) in millimeters.
 B. The true-position pin spacing is 0.100 (2,54) between centerlines. Each centerline is located within 0.010 (0,26) of its true longitudinal position relative to pins 1 and 14.
 C. Associated centerlines of character segments and decimal point dimensions are nominal.
 D. This drawing is subject to change without notice.

Figure 5. Package P — Plastic Dual-In-Line Packaging Configuration

PRODUCTION DATA — information in this document is current at publication date. Products conform to specifications in accordance with the terms of Texas Advanced Optoelectronic Solutions, Inc. standard warranty. Production processing does not necessarily include testing of all parameters.

NOTICE

Texas Advanced Optoelectronic Solutions, Inc. (TAOS) reserves the right to make changes to the products contained in this document to improve performance or for any other purpose, or to discontinue them without notice. Customers are advised to contact TAOS to obtain the latest product information before placing orders or designing TAOS products into systems.

TAOS assumes no responsibility for the use of any products or circuits described in this document or customer product design, conveys no license, either expressed or implied, under any patent or other right, and makes no representation that the circuits are free of patent infringement. TAOS further makes no claim as to the suitability of its products for any particular purpose, nor does TAOS assume any liability arising out of the use of any product or circuit, and specifically disclaims any and all liability, including without limitation consequential or incidental damages.

TEXAS ADVANCED OPTOELECTRONIC SOLUTIONS, INC. PRODUCTS ARE NOT DESIGNED OR INTENDED FOR USE IN CRITICAL APPLICATIONS IN WHICH THE FAILURE OR MALFUNCTION OF THE TAOS PRODUCT MAY RESULT IN PERSONAL INJURY OR DEATH. USE OF TAOS PRODUCTS IN LIFE SUPPORT SYSTEMS IS EXPRESSLY UNAUTHORIZED AND ANY SUCH USE BY A CUSTOMER IS COMPLETELY AT THE CUSTOMER'S RISK.

LUMENOLOGY, TAOS, the TAOS logo, and Texas Advanced Optoelectronic Solutions are registered trademarks of Texas Advanced Optoelectronic Solutions Incorporated.

TIL311 HEXADECIMAL DISPLAY WITH LOGIC

TAOS058 – JANUARY 2004
