

# TCP-3068H

## Advance Information

# 6.8 pF Passive Tunable Integrated Circuits (PTIC)

### Introduction

ON Semiconductor's PTICs have excellent RF performance and power consumption, making them suitable for any mobile handset or radio application. The fundamental building block of our PTIC product line is a tunable material called ParaScan™, based on Barium Strontium Titanate (BST). PTICs have the ability to change their capacitance from a supplied bias voltage generated by the Control IC. The 6.8 pF PTICs are available as wafer-level chip scale packages (WLCSP) and in QFN packages for easy mounting directly on printed circuit boards.

### Key Features

- High Tuning Range and Operation up to 20 V
- Usable Frequency Range: from 700 MHz to 2.7 GHz
- High Quality Factor (Q) for Low Loss
- High Power Handling Capability
- Compatible with PTIC Control IC TCC-103
- WLCSP Package: 0.722 x 1.179 x 0.611 mm (12 pillar)
- QFN Package: 1.200 x 1.600 x 0.950 mm
- QFN: MSL-2 Moisture Sensitivity Level (per J-STD-020)
- Pb-Free and RoHS Compliant

### Typical Applications

- Multi-band, Multi-standard, Advanced and Simple Mobile Phones
- Tunable Antenna Matching Networks
- Tunable RF Filters
- Active Antennas

This document contains information on a new product. Specifications and information herein are subject to change without notice.



ON Semiconductor®

<http://onsemi.com>

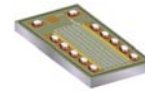

WLCSP  
12 pillar  
CASE TBD



QFN  
6 pin  
CASE TBD

### QFN MARKING DIAGRAM

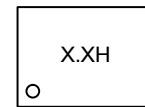

X.X = 6.8  
H = High Tuning

### FUNCTIONAL BLOCK DIAGRAM

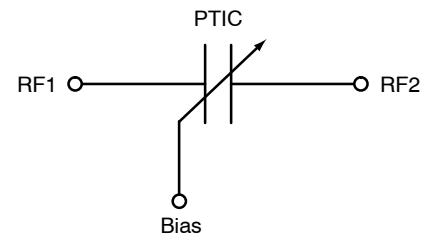

Figure 1. PTIC Functional Block Diagram

### ORDERING INFORMATION

Device	Package	Shipping
TCP-3068H-DT	WLCSP (Pb-Free)	4000 Units / 7" Reel
TCP-3068H-QT	QFN (Pb-Free)	8000 Units / 13" Reel

For detailed ordering information, including part number definition and capacitance (pF) see the package dimensions section on page 7 of this datasheet.

# TCP-3068H

## TYPICAL SPECIFICATIONS

### Representative Performance Data at 25°C

**Table 1. PERFORMANCE DATA**

Parameter	Min	Typ	Max	Units
Operating Bias Voltage	2.0		20	V
Capacitance ( $V_{bias} = 2\text{ V}$ )	6.12	6.80	7.48	pF
Capacitance ( $V_{bias} = 20\text{ V}$ )	1.70	1.79	1.88	pF
Tuning Range (2 V - 20 V)	3.40	3.80	4.20	
Tuning Range (20 V - 2 V)		3.60		
Leakage Current (WLCSP)			2.0	$\mu\text{A}$
Operating Frequency	700		2700	MHz
Quality Factor @ 700 MHz, 10 V		100		
Quality Factor @ 2.4 GHz, 10 V		75		
IP3 ( $V_{bias} = 2\text{ V}$ ) [1,3]		70		dBm
IP3 ( $V_{bias} = 20\text{ V}$ ) [1,3]		85		dBm
2nd Harmonic ( $V_{bias} = 2\text{ V}$ ) [2,3]		-70		dBm
2nd Harmonic ( $V_{bias} = 20\text{ V}$ ) [2,3]		-80		dBm
3rd Harmonic ( $V_{bias} = 2\text{ V}$ ) [2,3]		-40		dBm
3rd Harmonic ( $V_{bias} = 20\text{ V}$ ) [2,3]		-70		dBm
Transition Time (Cmin $\rightarrow$ Cmax) [4]		80		$\mu\text{s}$
Transition Time (Cmax $\rightarrow$ Cmin) [4]		70		$\mu\text{s}$

1.  $f_1 = 850\text{ MHz}$ ,  $f_2 = 860\text{ MHz}$ , Pin 25 dBm/Tone
2. 850 MHz, Pin +34 dBm
3. IP3 and Harmonics are measured in the shunt configuration in a 50  $\Omega$  environment
4. RF<sub>IN</sub> and RF<sub>OUT</sub> are both connected to DC ground

# TCP-3068H

## Representative performance data at 25°C for 6.8 pF WLCSP Package

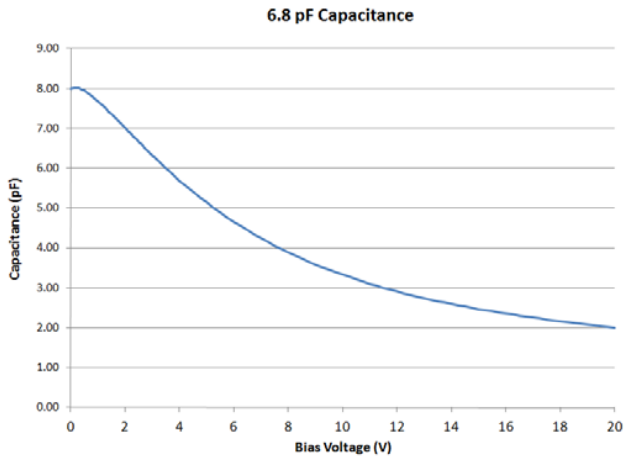

Figure 2. Capacitance

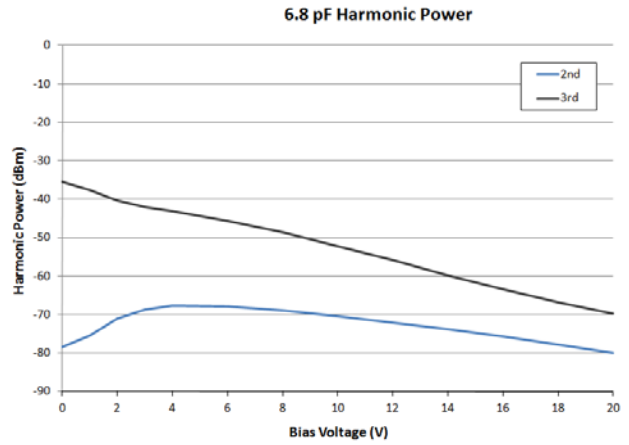

Figure 3. Harmonic Power\*

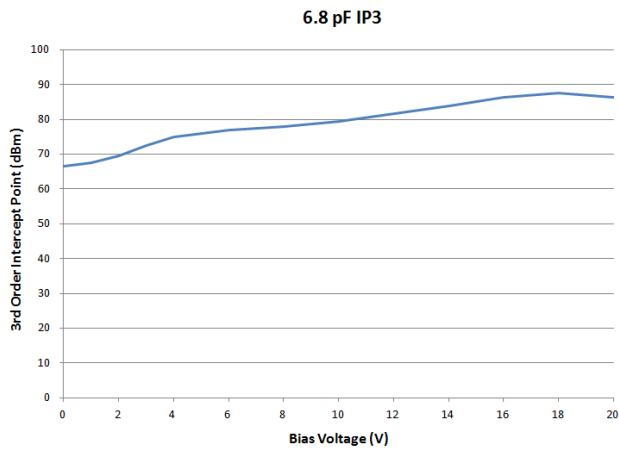

Figure 4. IP3\*

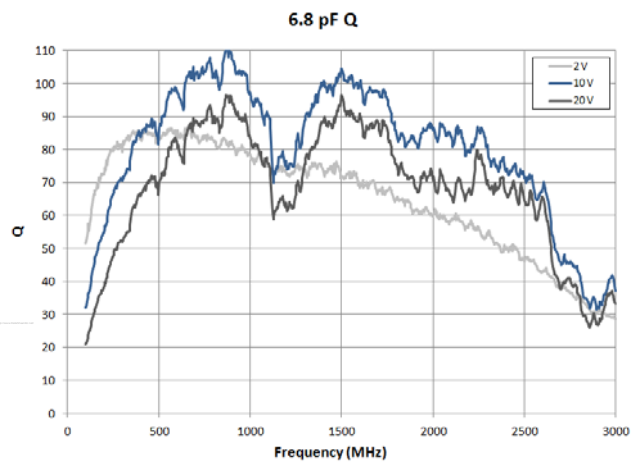

Figure 5. Q\*

\*The data shown is based on the TCP-3068N device performance, for reference only. The TCP-3068H performance data will be available in the Production Datasheet.

Table 2. ABSOLUTE MAXIMUM RATINGS

Parameter	Rating	Units
Input Power	+40	dBm
Bias Voltage	+25 (Note 5)	V
Operating Temperature Range	-30 to +85	°C
Storage Temperature Range	-55 to +125	°C
ESD – Human Body Model	Class 1A JEDEC HBM Standard (Note 6)	

Stresses exceeding Maximum Ratings may damage the device. Maximum Ratings are stress ratings only. Functional operation above the Recommended Operating Conditions is not implied. Extended exposure to stresses above the Recommended Operating Conditions may affect device reliability.

5. WLCSP: Recommended Bias Voltage not to exceed 20 V

6. Class 1A defined as passing 250 V, but may fail after exposure to 500 V ESD pulse

# TCP-3068H

## PACKAGE INFORMATION

### QFN Package Layout and Dimensional Information

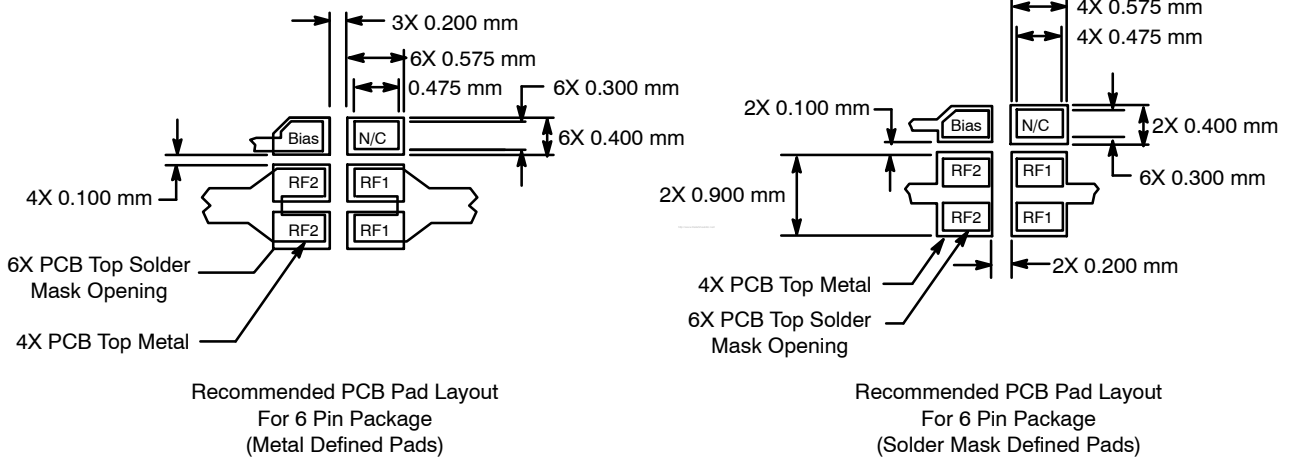
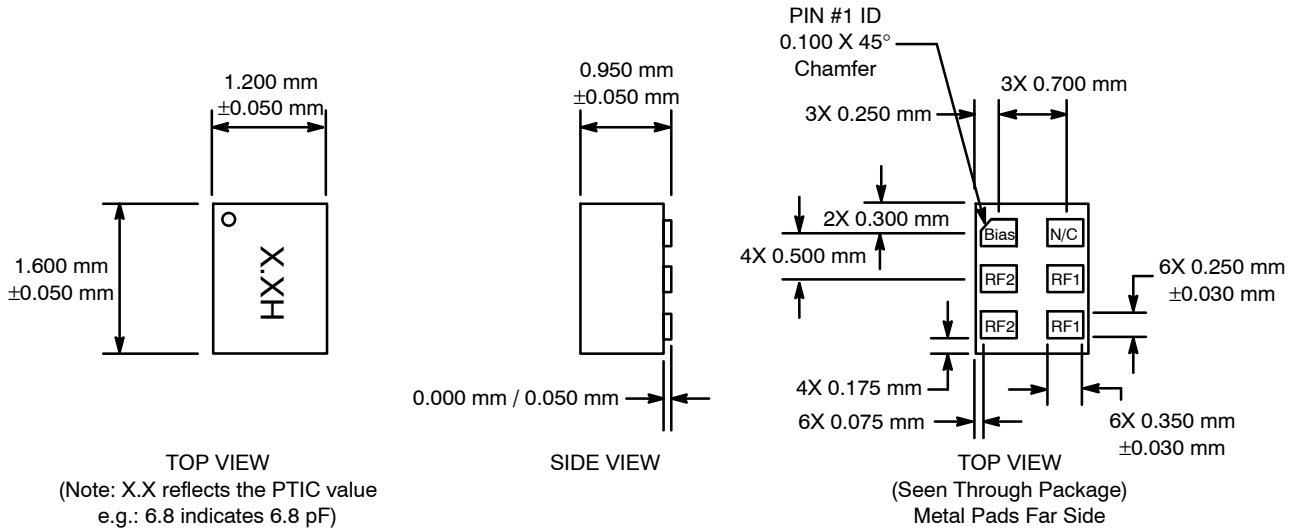

Note:  
 2X means 2 sites with the specific value  
 3X means 3 sites with the specific value  
 4X means 4 sites with the specific value  
 0.9 mm pad layout is standard for all products. Shorter pad layouts can be considered for smaller products.

**Figure 6. QFN Pin Markers and Dimensions**

# TCP-3068H

## Wafer Level Chip Scale Package (WLCSP) Layout and Dimensional Information

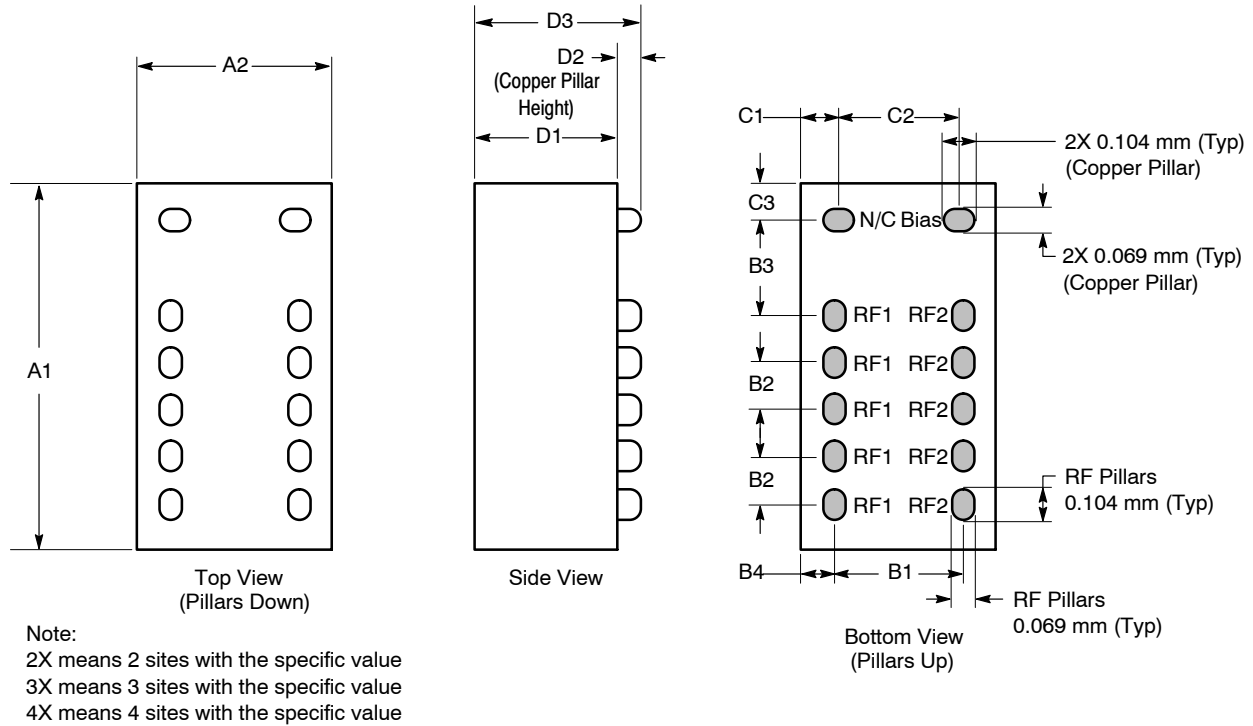

Figure 7. WLCSP Pin Markers and Dimensions

Table 3. PACKAGE DIMENSIONS

(All dimensions are in millimeters)

WLCSP *	DIM	Nominal	Max	Device
8P	A1	0.879		1.2, 2.7 pF
10P	A1	1.029		3.3, 3.9 pF
12P	A1	1.179		4.7, 5.6, 6.8, 8.2 pF
14P	A1	1.329		
ALL	A2	0.722		
ALL	B1	0.460		
ALL	B2	0.150		
ALL	B3	0.300		
ALL	B4	0.130		
ALL	C1	0.148		
ALL	C2	0.425		
ALL	C3	0.130		
ALL	D1	0.530		
ALL	D2	0.081		

\*Total number of pillars

Top View Recommended PCB Pad Layout (Metal Defined Pad)

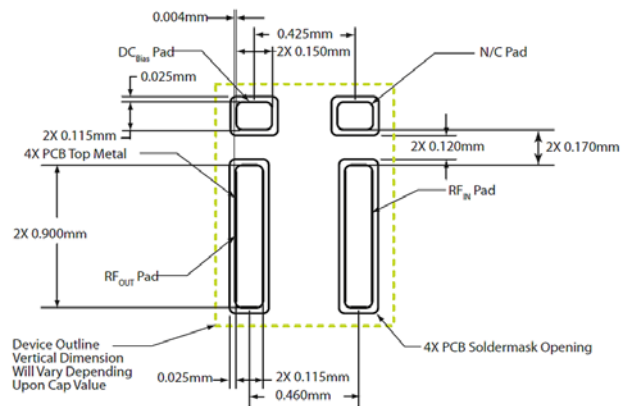

Note:  
 0.9 mm pad layout is standard for all products. Shorter pad layouts can be considered for smaller products.

Figure 8. Recommended Pad Layout

**ASSEMBLY CONSIDERATIONS AND REFLOW PROFILE**

The following assembly considerations should be observed:

**Cleanliness**

These chips should be handled in a clean environment.

**Electro-static Sensitivity**

ON Semiconductor’s PTICs are ESD Class 1A sensitive. The proper ESD handling procedures should be used.

**Mounting**

The WLCSP PTIC is fabricated for Flip Chip solder mounting. Connectivity to the RF and Bias terminations on the PTIC die is established through copper pillar posts (53 μm nominal height) topped with lead-free SAC351 solder caps (28 μm nominal height). The PTIC die is RoHS-compliant and compatible with lead-free soldering profile.

**Post-reflow Cleaning**

Use of ultrasonic cleaning is not recommended for pillared devices as it may lead to premature fatigue failure of the pillars.

**Molding**

The PTIC die is compatible for over-molding or under-fill.

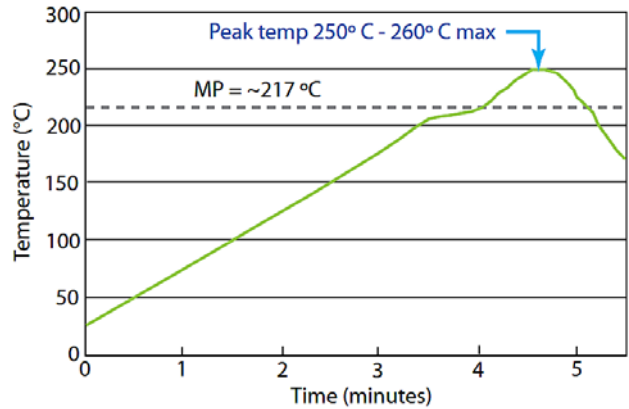

*This reflow profile is a guideline for Pb-free solder materials. Adjustments to this profile are necessary based on specific process requirements and board size, thickness and density. Not to exceed 260° C for 5 seconds.*

**Figure 9. Reflow Profile**

**ORIENTATION OF THE PTIC FOR OPTIMUM LOSSES**

When configuring the PTIC in your specific circuit design, at least one of the RF terminals must be connected to DC ground. If minimum transition times are required, DC ground on both RF terminals is recommended. To minimize losses, the PTIC should be oriented such that RF2 is at the lower RF impedance of the two RF nodes. A shunt PTIC, for example, should have RF2 connected to RF ground.

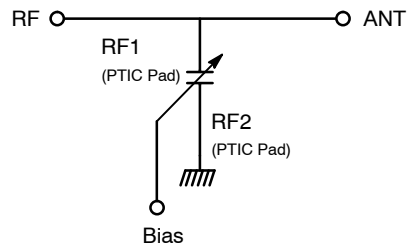

**Figure 10. PTIC Orientation Functional Block Diagram**

# TCP-3068H

## PART NUMBER DEFINITION

Example: TCP-3068H-DT

TCP		-	30	68	H	-	D	T
<u>Product Family</u>	<u>Process Status</u>		<u>Process Generation</u>	<u>Capacitor Value</u>	<u>Tuning</u>		<u>Package / Format</u>	<u>Packing</u>
TCP	"blank" = Production X = Pilot Production S = Special/Custom P = Prototype		10= Gen 1.0 30= Gen 3.0	12 = 1.2pF 27 = 2.7pF 33 = 3.3pF 39 = 3.9pF 47 = 4.7pF 56 = 5.6pF 68 = 6.8pF 82 = 8.2pF	N = Normal H = High		D = WLCSP Q = QFN	T = T&R

**Table 4. PART NUMBERS**

Part Number	Capacitance		Package*
	2 V	20 V	
TCP-3068H-DT	6.80	1.79	12-Pillar WLCSP
TCP-3068H-QT	6.80	1.79	6-Pin QFN

\*See PTIC package dimensions on page 5

# TCP-3068H

## TAPE & REEL DIMENSIONS

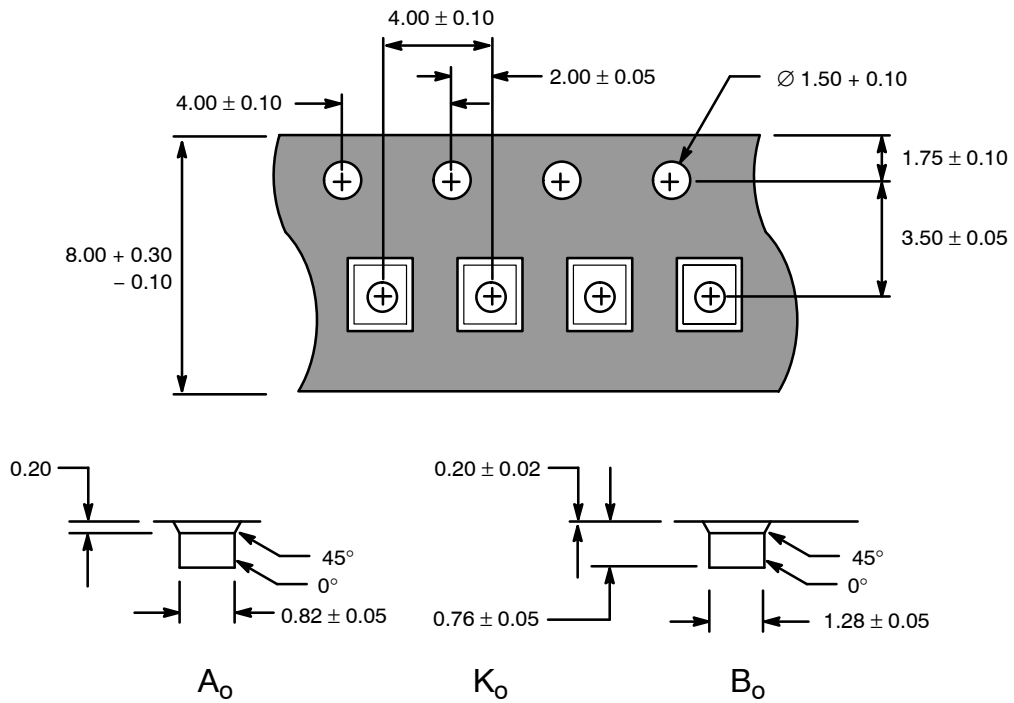

Note: The reel size is 7"  
Pocket may have a hole  $0.2 \text{ mm to } 0.4 \text{ mm} \pm 0.05 \text{ mm}$

Figure 11. 12 Pillar WLCSP Carrier Tape Drawing



# TCP-3068H

## TAPE & REEL DIMENSIONS (Cont'd)

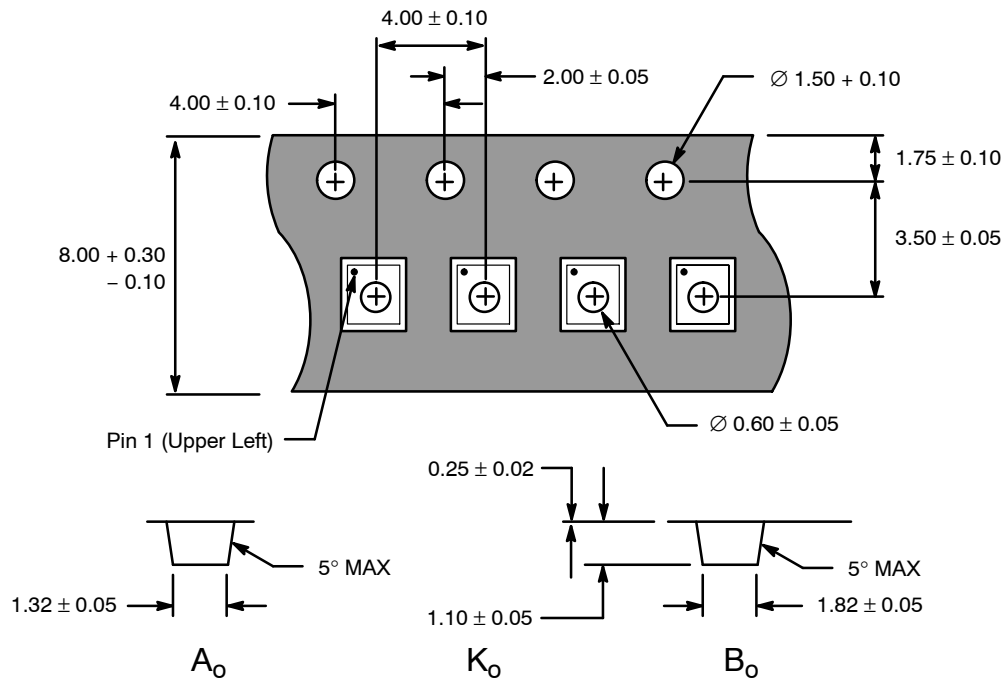

Figure 12. QFN Carrier Tape Drawing

### POCKET DIMENSION

Pocket Dimension (mm)				Unit Dimension (mm)			
	Spec	Max	Min		Spec	Max	Min
Ao	1.32 ± 0.05	1.37	1.27	A	1.2 ± 0.05	1.25	1.15
Bo	1.82 ± 0.05	1.87	1.77	B	1.6 ± 0.05	1.65	1.55
Ko	1.1 ± 0.05	1.15	1.05	K	0.95 ± 0.05	1.00	0.90

NOTE: The reel size is 13"

ParaScan is a trademark of Paratek Microwave, Inc.

**ON Semiconductor** and **ON** are registered trademarks of Semiconductor Components Industries, LLC (SCILLC). SCILLC owns the rights to a number of patents, trademarks, copyrights, trade secrets, and other intellectual property. A listing of SCILLC's product/patent coverage may be accessed at [www.onsemi.com/site/pdf/Patent-Marking.pdf](http://www.onsemi.com/site/pdf/Patent-Marking.pdf). SCILLC reserves the right to make changes without further notice to any products herein. SCILLC makes no warranty, representation or guarantee regarding the suitability of its products for any particular purpose, nor does SCILLC assume any liability arising out of the application or use of any product or circuit, and specifically disclaims any and all liability, including without limitation special, consequential or incidental damages. "Typical" parameters which may be provided in SCILLC data sheets and/or specifications can and do vary in different applications and actual performance may vary over time. All operating parameters, including "Typicals" must be validated for each customer application by customer's technical experts. SCILLC does not convey any license under its patent rights nor the rights of others. SCILLC products are not designed, intended, or authorized for use as components in systems intended for surgical implant into the body, or other applications intended to support or sustain life, or for any other application in which the failure of the SCILLC product could create a situation where personal injury or death may occur. Should Buyer purchase or use SCILLC products for any such unintended or unauthorized application, Buyer shall indemnify and hold SCILLC and its officers, employees, subsidiaries, affiliates, and distributors harmless against all claims, costs, damages, and expenses, and reasonable attorney fees arising out of, directly or indirectly, any claim of personal injury or death associated with such unintended or unauthorized use, even if such claim alleges that SCILLC was negligent regarding the design or manufacture of the part. SCILLC is an Equal Opportunity/Affirmative Action Employer. This literature is subject to all applicable copyright laws and is not for resale in any manner.

### PUBLICATION ORDERING INFORMATION

**LITERATURE FULFILLMENT:**  
Literature Distribution Center for ON Semiconductor  
P.O. Box 5163, Denver, Colorado 80217 USA  
**Phone:** 303-675-2175 or 800-344-3860 Toll Free USA/Canada  
**Fax:** 303-675-2176 or 800-344-3867 Toll Free USA/Canada  
**Email:** [orderlit@onsemi.com](mailto:orderlit@onsemi.com)

**N. American Technical Support:** 800-282-9855 Toll Free  
USA/Canada  
**Europe, Middle East and Africa Technical Support:**  
Phone: 421 33 790 2910  
**Japan Customer Focus Center**  
Phone: 81-3-5817-1050

**ON Semiconductor Website:** [www.onsemi.com](http://www.onsemi.com)  
**Order Literature:** <http://www.onsemi.com/orderlit>  
For additional information, please contact your local Sales Representative