

SM520AF-E thru SM5100AF-E

Schottky Barrier Rectifiers

Reverse Voltage 20 to 100V Forward Current 5.0A

FEATURES

- * Plastic package has Underwriters Laboratory Flammability Classification 94V-0
- * Low power loss, high efficiency
- * For use in low voltage high frequency inverters, free wheeling, and polarity protection applications
- * Guardring for over voltage protection
- * High temperature soldering guaranteed: 260°C/10 seconds at terminals
- * IEC61000-4-2 ESD Air Contact ≥ 15 KV

Mechanical Data

Case: JEDEC SMA-FL,

molded plastic over SKY body

Terminals: Plated leads, solderable per

MIL-STD-750, Method 2026

Polarity: Color band denotes cathode end

Mounting Position: Any

Weight: 0.0327 g

Handling precaution: None

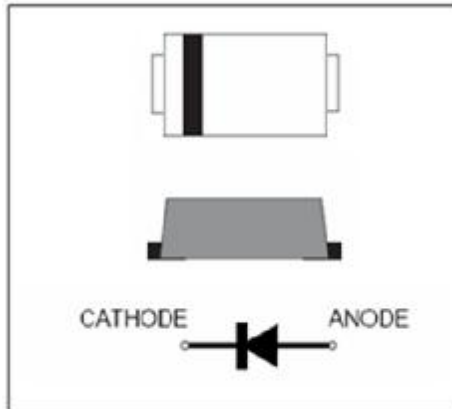

We declare that the material of product is Halogen free (green epoxy compound)

1. Electrical Characteristic

Maximum & Thermal Characteristics Ratings at 25°C ambient temperature unless otherwise specified.

Parameter Symbol	symbol	SM520A F-E	SM530A F-E	SM540A F-E	SM550A F-E	SM560A F-E	SM580A F-E	SM5100 AF-E	Unit
device marking code		S52 •	S53 •	S54 •	S55 •	S56 •	S58 •	S510 •	
Maximum repetitive peak reverse voltage	V_{RRM}	20	30	40	50	60	80	100	V
Maximum RSM voltage	V_{RSM}	14	21	28	35	42	56	70	V
Maximum DC blocking voltage	V_{DC}	20	30	40	50	60	80	100	V
Maximum average forward rectified current at TC = 80°C	IF(AV)	5.0							A
Peak forward surge current 8.3ms single half sine-wave superimposed on rated load (JEDEC Method)	I_{FSM}	100							A
Typical thermal resistance (Note 1)	R θ JA	150							°C/W
Operating junction and storage temperature range	TJ, TSTG	-40 to +150							°C

Electrical Characteristics Ratings at 25°C ambient temperature unless otherwise specified.

Parameter Symbol	symbol	SM520A F-E	SM530A F-E	SM540A F-E	SM550A F-E	SM560A F-E	SM580A F-E	SM5100 AF-E	Unit	
Maximum instantaneous forward voltage at 5.0A	V_F	0.50			0.70		0.85		V	
Maximum DC reverse current TA = 25°C at rated DC blocking voltage TJ = 125°C	IR	0.1				10.0				mA
Typical junction capacitance at 4.0V, 1MHz	CJ	110								PF

NOTES:

1. 8.0mm² (.013mm thick) land areas

SM520AF-E thru SM5100AF-E

2. Ratings and Characteristic Curves (TA = 25°C unless otherwise noted)

Fig. 1 - Forward Current Derating Curve

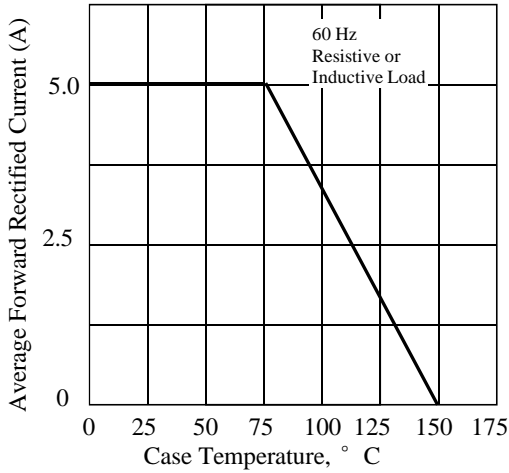

Fig. 2 - Maximum Non-repetitive Peak Forward Surge Current

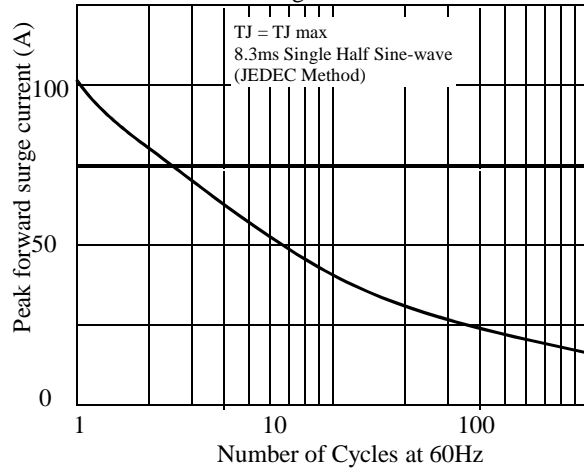

Fig 3. - Typical Instantaneous Forward Characteristics

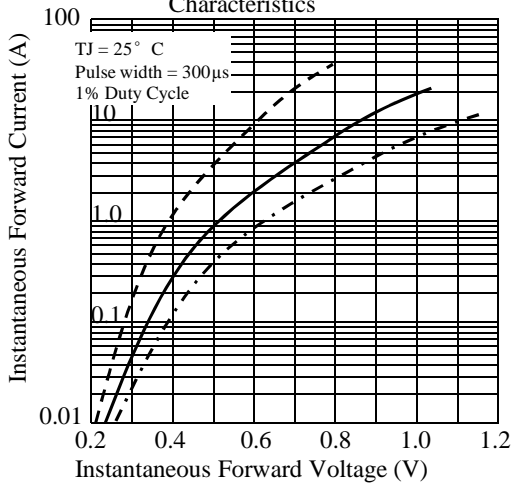

Fig 4. - Typical Reverse Characteristics

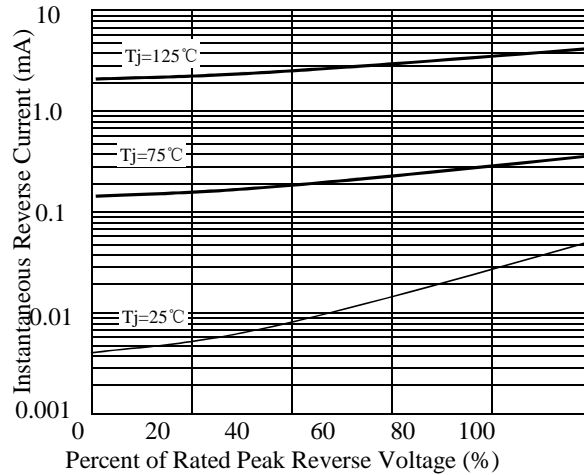

Fig 5. - typical transient thermal impedance

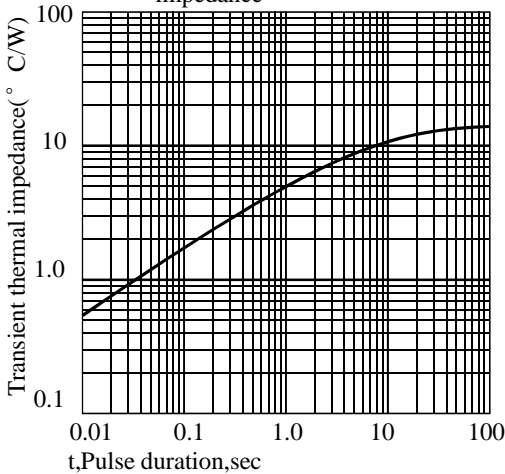
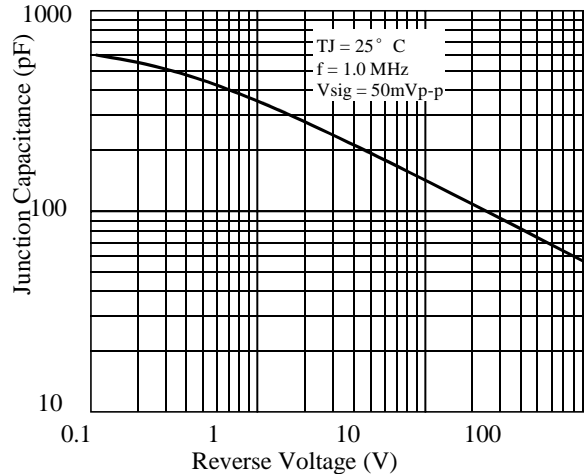

Fig 6. - Typical Junction Capacitance



SM520AF-E thru SM5100AF-E

3. dimension:

SMA-FL

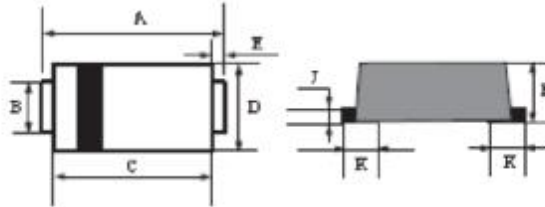

DIM	MILLIMETERS		INCHES	
	MIN	MAX	MIN	MAX
A	4.4	4.8	0.173	0.189
B	1.3	1.5	0.051	0.059
C	3.3	3.7	0.130	0.146
D	2.3	2.7	0.091	0.106
E	0.90Typ		0.035Typ	
H	0.9	1.2	0.036	0.047
J	0.11	0.21	0.005	0.009

Suggested solder pad layout

Mounting Pad Layout

SMA-FL

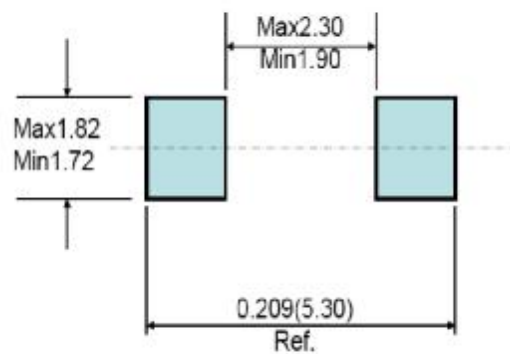

SM540AF-E: "S"--肖特基产品; "M"--表面贴装; "5"--正向电流5A; "40"---VB为40V; 封装;
 "AF"--SMA-FL封装; 无卤环氧; "E"--满足ESD大于15KV.

5.1 、 SMD Packing Reel Spec & Packing Quantity

5.1.1 Reel Packing

A. Reel Spec



unit: mm

SPEC	A	B	C	W	Quantity/Reel
SMA-FL 7" reel	177.0±2.0	54.0±0.5	13.0±0.5	13.2±0.2	3K
TO277 13" reel	330.0±2.0	75.0±0.5	13.0±0.5	13.2±0.2	5K
SOD123FL 7" reel	177.0±2.0	50.0±0.5	13.0±0.5	9.4±1.5	3K
SOD323HE 7" reel	177.0±2.0	50.0±0.5	13.0±0.5	9.4±1.5	3K
SMB-FL 13" reel	330.0±2.0	75.0±0.5	13.0±0.5	13.2±0.2	5K

B. 13" reel packing box



unit: mm

size	A	B	C
	335±5.0	335±2.0	40±1.0

as per above packing

Spec	Q' ty/Box
TO277 13" reel	10K
SMB-FL 13" reel	10K

C. 7" reel packing box

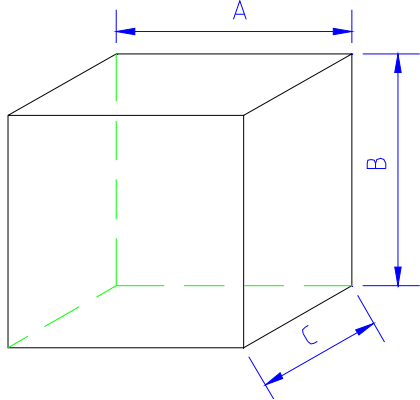

unit: mm

	A	B	C
SMA-FL SOD123FL SOD323HE	186±2.0	139±2.0	185±2.0

as per above packing

	Q' ty/Box
SMA-FL	30K
SOD123FL	30K
SOD323HE	30K

D. reel packing carton

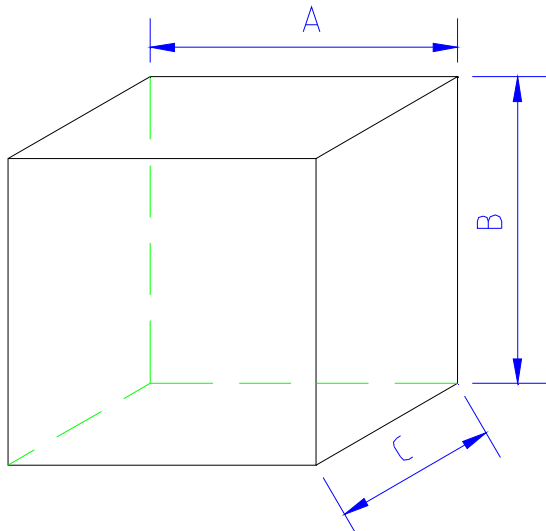

unit: mm

	A	B	C
size	350±2.0	340±2.0	350±2.0

as per above packing

Spec	Q' ty/Carton
TO277 13" reel	80K
SMB-FL 13" reel	80K

unit: mm

	A	B	C
SMA-FL SOD123FL SOD323HE	455±2.0	400±2.0	410±2.0

as per above packing

Spec	Q' ty/Carton
SMA-FL 7" reel	360K
SOD123-FL 7" reel	360K
SOD323HE 7" reel	360K

5.1.2 Tape Spec

A. Cover Tape

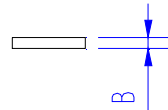

unit: mm

	A	B
SMA-FL SMB-FL TO277	9.5±0.10	0.062±0.007
SOD123FL SOD323HE	5.4±0.10	

B. Carrier Tape

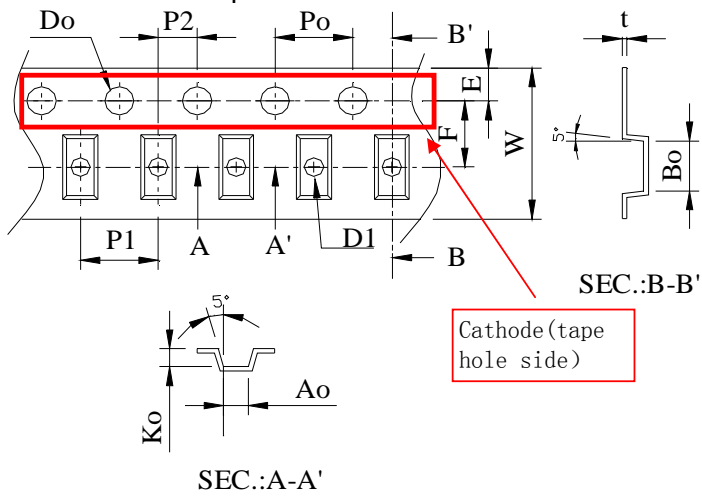

Item	SOD323HE	SOD123FL	SMA-FL	SMB-FL	TO277
W	8±0.3	8±0.3	12±0.3	12±0.3	12±0.3
P1	4±0.1	4±0.1	4±0.1	8±0.1	8±0.1
E	1.75±0.1	1.75±0.1	1.75±0.1	1.75±0.1	1.75±0.1
F	3.5±0.05	3.5±0.05	5.5±0.05	5.5±0.05	5.5±0.05
D0	1.55±0.05	1.55±0.05	1.55±0.05	1.55±0.05	1.55±0.05
D1	1.1±0.1	1.1±0.1	1.5±0.1	1.55±0.05	1.5±0.1
P0	4±0.1	4±0.1	4±0.1	4±0.1	4±0.1
P2	2±0.05	2±0.05	2±0.05	2±0.05	2±0.05
10P0	40±0.2	40±0.2	40±0.2	40±0.2	40±0.2
A0	1.45±0.1	1.95±0.1	2.83±0.1	3.8±0.1	4.3±0.1
B0	2.75±0.1	3.95±0.1	4.75±0.1	5.75±0.1	6.8±0.1
K0	0.80±0.1	1.30±0.1	1.42±0.1	1.4±0.1	1.35±0.1
T	0.25±0.05	0.25±0.05	0.25±0.05	0.25±0.05	0.25±0.05

5.2、SMD Power Diode General Packing Spec

A. 7" reel all labels will be at cathode side of reel ;

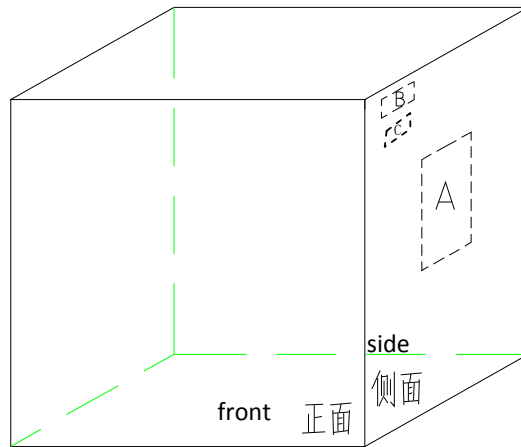
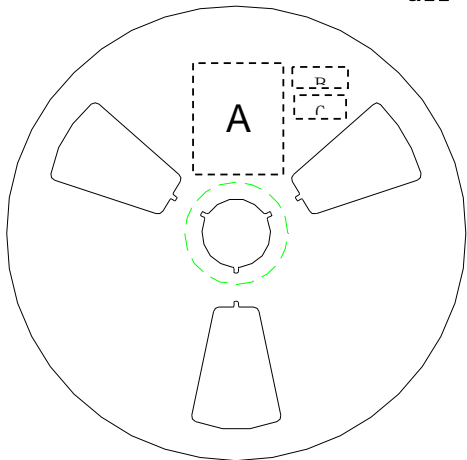

A:LRC label; B:Environment Label C:Halide free label

B. 13" reel

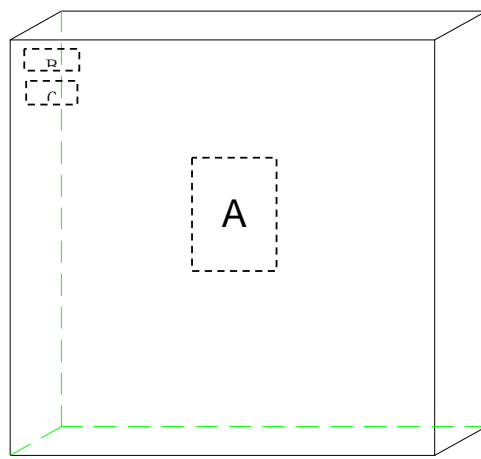
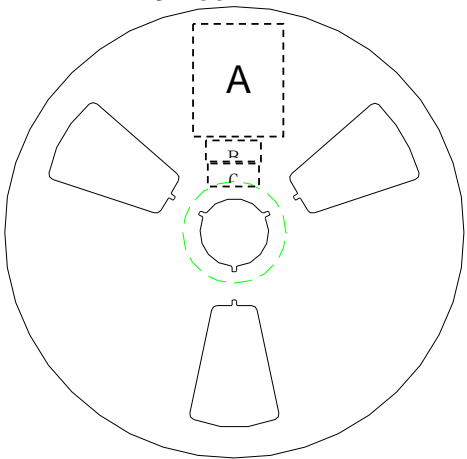

A:LRC label; B:Environment Labe C:Halide free label

C. Tape lead: face anode side of the reel, upper side is the tape lead position. All labels are at cathode side of the reel.



标题: Power Diode SMD Package Packing Spec	DOC NO.: WI-258
	Version: 5 Modification: 0
	Page: 6

C. Label Content :
LRC Label

P/N → (1P) LPN: SM140A
 Lot No. → (1T) LOT: 140106049X
 Date code → (9D) DTE: 1403
 Quantity → (Q) QTY: 10000

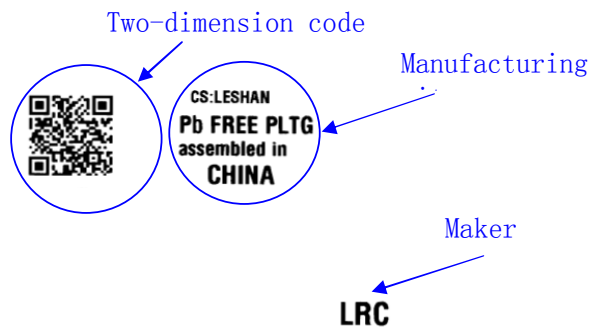

lot: 140106049X: 140106---2014/1/6; 049----lot number:49; X: product code

Environment Label



Halide-free Label



SM520AF-E thru SM5100AF-E

4. Update Record

版次	更新记录	更新作者	更新日期
1	第一版	周杰	2014/4/25