

## N-Channel Enhancement Mode MOSFET

### Features

- 30V/65A,  
 $R_{DS(ON)} = 5.3m\Omega$  (Max.) @  $V_{GS} = 10V$   
 $R_{DS(ON)} = 7.5m\Omega$  (Max.) @  $V_{GS} = 4.5V$
- Reliable and Rugged
- ESD Protection
- Lead Free and Green Devices Available  
 (RoHS Compliant)



### Applications

- Power Management in Desktop Computer or DC/DC Converters.

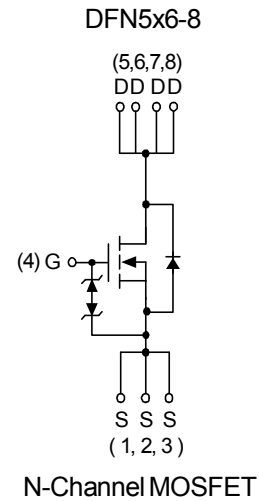
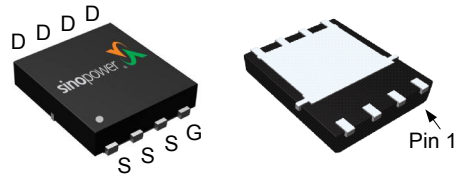
### Pin Description

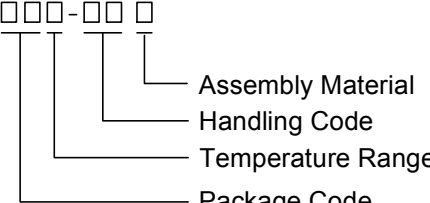

### Ordering and Marking Information

<p>SM4336NS <span style="font-family: monospace;">□□□-□□□</span></p>  <p style="margin-left: 150px;">             Assembly Material              Handling Code              Temperature Range              Package Code         </p>	<p>Package Code              KP : DFN5x6-8              Operating Junction Temperature Range              C : -55 to 150 °C              Handling Code              TR : Tape &amp; Reel (2500ea/reel)              Assembly Material              G : Halogen and Lead Free Device</p>
<p>SM4336NS KP : <span style="border: 1px solid black; padding: 2px; display: inline-block; text-align: center;">                   SM4336                  XXXXX             </span></p>	<p>XXXXX - Lot Code</p>

Note : SINOPOWER lead-free products contain molding compounds/die attach materials and 100% matte tin plate termination finish; which are fully compliant with RoHS. SINOPOWER lead-free products meet or exceed the lead-free requirements of IPC/JEDEC J-STD-020D for MSL classification at lead-free peak reflow temperature. SINOPOWER defines "Green" to mean lead-free (RoHS compliant) and halogen free (Br or Cl does not exceed 900ppm by weight in homogeneous material and total of Br and Cl does not exceed 1500ppm by weight).

SINOPOWER reserves the right to make changes to improve reliability or manufacturability without notice, and advise customers to obtain the latest version of relevant information to verify before placing orders.

## Absolute Maximum Ratings (T<sub>A</sub> = 25°C Unless Otherwise Noted)

Symbol	Parameter	Rating	Unit	
<b>Common Ratings</b>				
V <sub>DSS</sub>	Drain-Source Voltage	30	V	
V <sub>GSS</sub>	Gate-Source Voltage	±20		
T <sub>J</sub>	Maximum Junction Temperature	150	°C	
T <sub>STG</sub>	Storage Temperature Range	-55 to 150		
I <sub>S</sub>	Diode Continuous Forward Current	T <sub>C</sub> =25°C	65	A
I <sub>D</sub>	Continuous Drain Current	T <sub>C</sub> =25°C	65	
		T <sub>C</sub> =100°C	40	
I <sub>DM</sub> <sup>a</sup>	Pulsed Drain Current	T <sub>C</sub> =25°C	160	A
P <sub>D</sub>	Maximum Power Dissipation	T <sub>C</sub> =25°C	36.7	W
		T <sub>C</sub> =100°C	14.7	
R <sub>θJC</sub>	Thermal Resistance-Junction to Case	Steady State	3.4	°C/W
I <sub>D</sub>	Continuous Drain Current	T <sub>A</sub> =25°C	18	A
		T <sub>A</sub> =70°C	15	A
P <sub>D</sub>	Maximum Power Dissipation	T <sub>A</sub> =25°C	3.1	W
		T <sub>A</sub> =70°C	2	
R <sub>θJA</sub>	Thermal Resistance-Junction to Ambient	t ≤ 10s	20	°C/W
		Steady State	40	
I <sub>AS</sub> <sup>b</sup>	Avalanche Current, Single pulse (L=0.1mH)		33	A
E <sub>AS</sub> <sup>b</sup>	Avalanche Energy, Single pulse (L=0.1mH)		54	mJ

Note a: Pulse width limited by maximum junction temperature.

Note b: UIS tested and pulse width limited by maximum junction temperature 150°C (initial temperature T<sub>J</sub>=25°C)

## Electrical Characteristics ( $T_A = 25^\circ\text{C}$ unless otherwise noted)

Symbol	Parameter	Test Conditions	Min.	Typ.	Max.	Unit
<b>Static Characteristics</b>						
$BV_{DSS}$	Drain-Source Breakdown Voltage	$V_{GS}=0V, I_{DS}=250\mu A$	30	-	-	V
$BV_{DSst}$	Drain-Source Breakdown Voltage (transient)	$V_{GS}=0V, I_{D(av)}=15A$ $T_{case}=25^\circ\text{C}, t_{transient}=100ns$	34	-	-	V
$I_{DSS}$	Zero Gate Voltage Drain Current	$V_{DS}=24V, V_{GS}=0V$	-	-	1	$\mu A$
		$T_J=125^\circ\text{C}$	-	-	30	
$V_{GS(th)}$	Gate Threshold Voltage	$V_{DS}=V_{GS}, I_{DS}=250\mu A$	1.5	1.8	2.5	V
$I_{GSS}$	Gate Leakage Current	$V_{GS}=\pm 20V, V_{DS}=0V$	-	-	$\pm 10$	$\mu A$
$R_{DS(ON)}^c$	Drain-Source On-state Resistance	$V_{GS}=10V, I_{DS}=30A$	-	4.4	5.3	$m\Omega$
	Drain-Source On-state Resistance	$V_{GS}=4.5V, I_{DS}=20A$	-	5.7	7.5	$m\Omega$
Gfs	Forward Transconductance	$V_{DS}=5V, I_{DS}=20A$	-	40	-	S
<b>Diode Characteristics</b>						
$V_{SD}^c$	Diode Forward Voltage	$I_{SD}=20A, V_{GS}=0V$	-	0.8	1.1	V
$t_{rr}$	Reverse Recovery Time	$I_{SD}=5A, dI_{SD}/dt=100A/\mu s$	-	15.2	-	ns
$t_a$	Charge Time		-	8.4	-	
$t_b$	Discharge Time		-	6.8	-	
$Q_{rr}$	Reverse Recovery Charge		-	7.7	-	
<b>Dynamic Characteristics <sup>d</sup></b>						
$R_G$	Gate Resistance	$V_{GS}=0V, V_{DS}=0V, f=1MHz$	2.3	2.9	3.5	$\Omega$
$C_{iss}$	Input Capacitance	$V_{GS}=0V,$ $V_{DS}=15V,$ Frequency=1.0MHz	1320	1650	1980	pF
$C_{oss}$	Output Capacitance		173	247	321	
$C_{rss}$	Reverse Transfer Capacitance		91	151	211	
$t_{d(ON)}$	Turn-on Delay Time		-	14	26	
$t_r$	Turn-on Rise Time	$V_{DD}=15V, R_L=15\Omega,$ $I_{DS}=1A, V_{GEN}=10V,$ $R_G=6\Omega$	-	9	17	
$t_{d(OFF)}$	Turn-off Delay Time	-	53	96		
$t_f$	Turn-off Fall Time	-	15	28		
<b>Gate Charge Characteristics <sup>d</sup></b>						
$Q_g$	Total Gate Charge	$V_{DS}=15V, V_{GS}=4.5V,$ $I_{DS}=30A$	-	13.5	19	nC
$Q_g$	Total Gate Charge	$V_{DS}=15V, V_{GS}=10V,$ $I_{DS}=30A$	-	29	-	
$Q_{gth}$	Threshold Gate Charge		-	3	-	
$Q_{gs}$	Gate-Source Charge		-	6.1	-	
$Q_{gd}$	Gate-Drain Charge		-	5.2	-	

Note c: Pulse test; pulse width $\leq 300\mu s$ , duty cycle $\leq 2\%$ .

Note d: Guaranteed by design, not subject to production testing.

## Typical Operating Characteristics

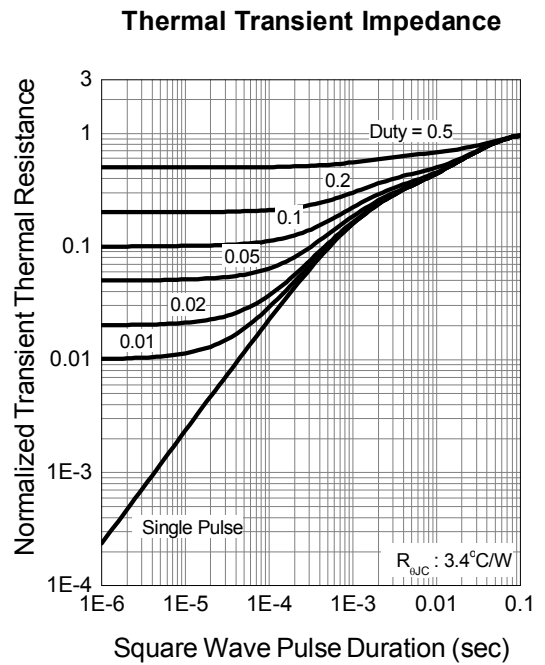
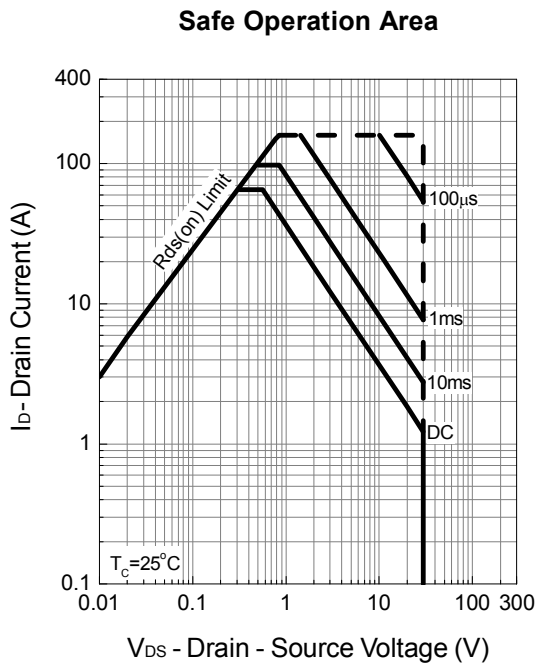
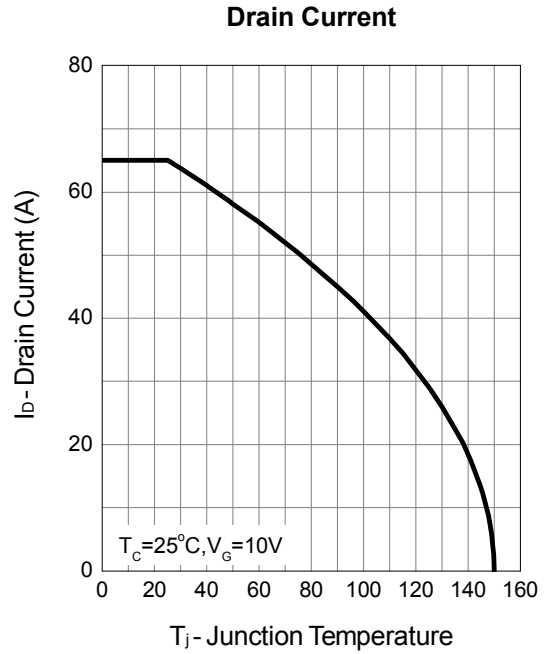
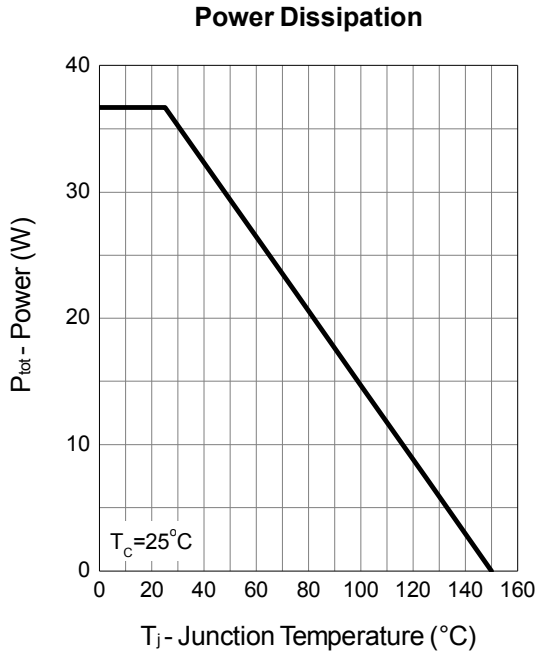

Typical Operating Characteristics (Cont.)

Output Characteristics

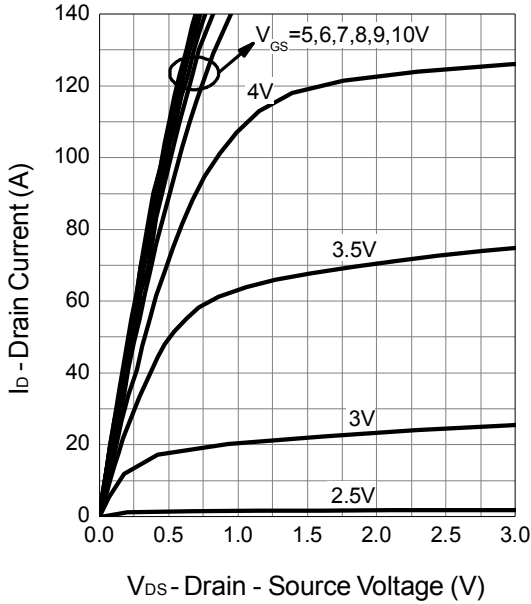

Drain-Source On Resistance

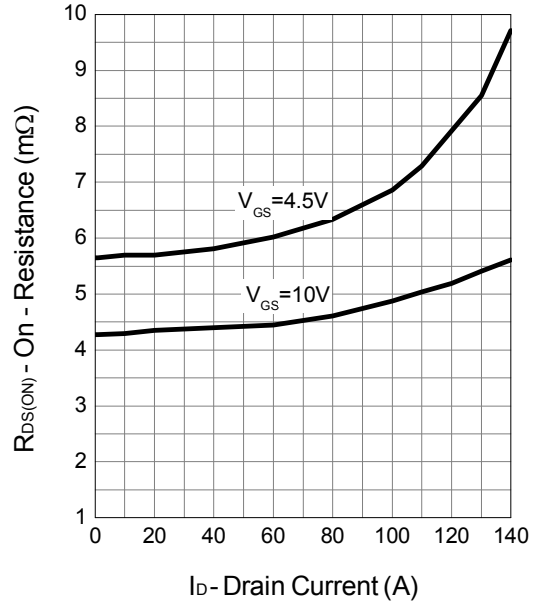

Gate-Source On Resistance

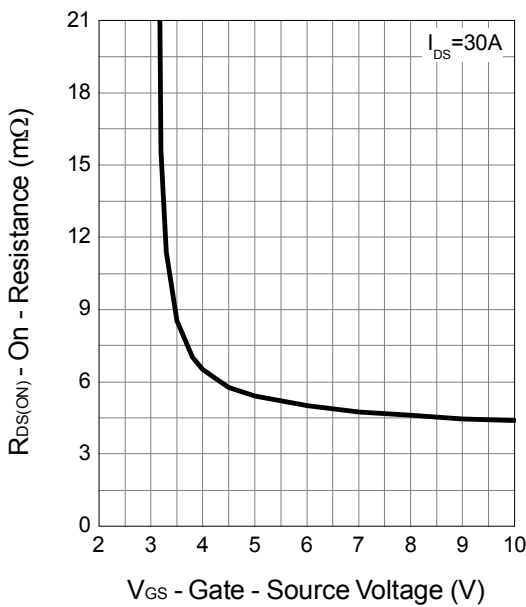

Gate Threshold Voltage

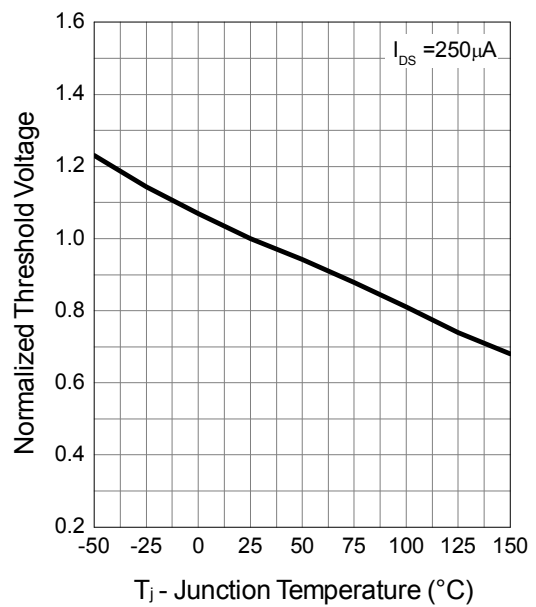

Typical Operating Characteristics (Cont.)

Drain-Source On Resistance

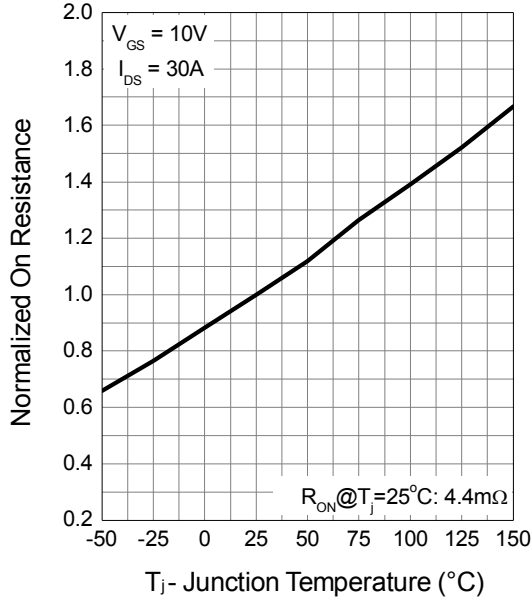

Source-Drain Diode Forward

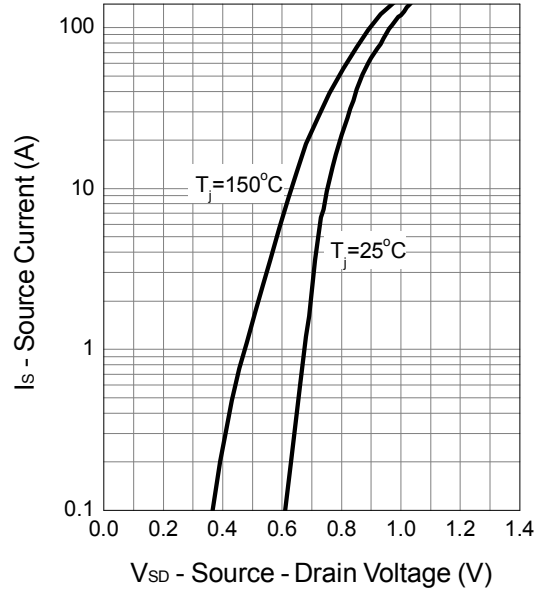

Capacitance

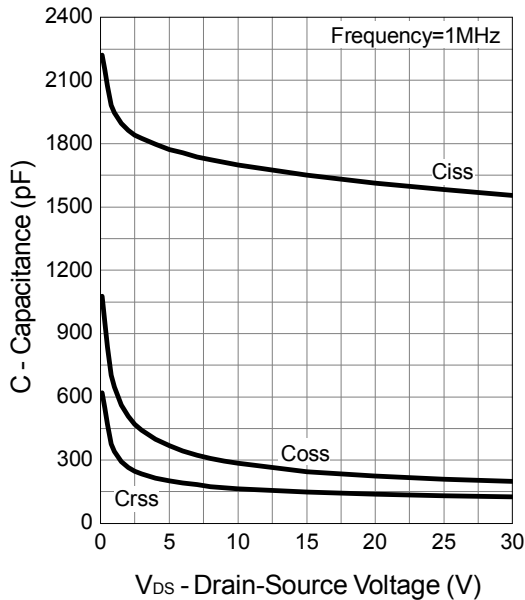

Gate Charge

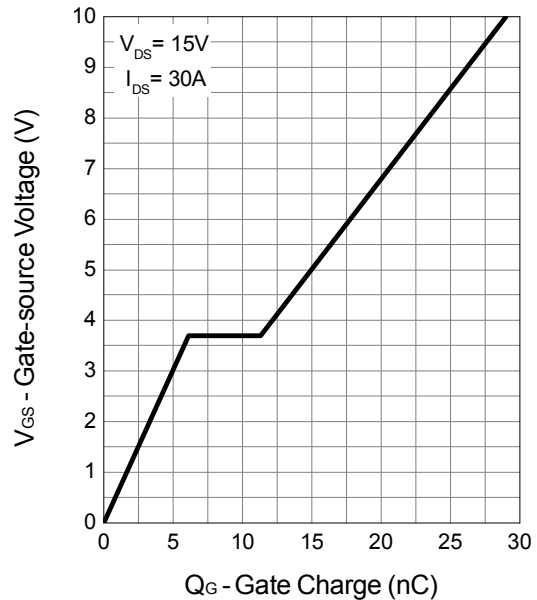

### Avalanche Test Circuit and Waveforms

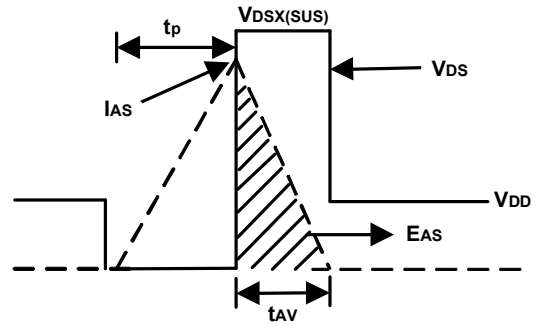
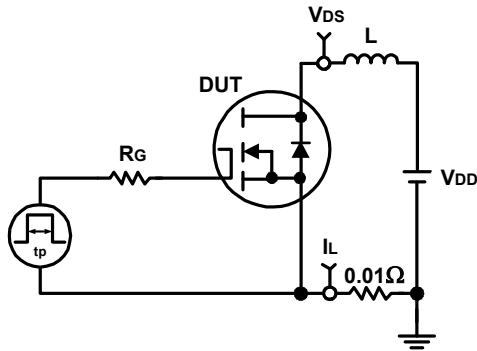

### Switching Time Test Circuit and Waveforms

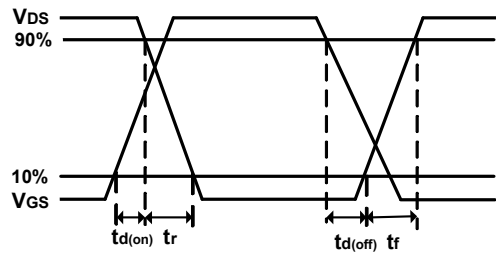
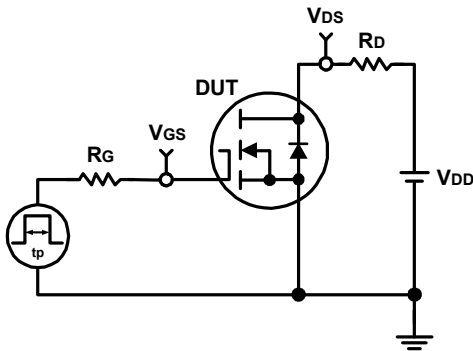

## Package Information

DFN5x6-8

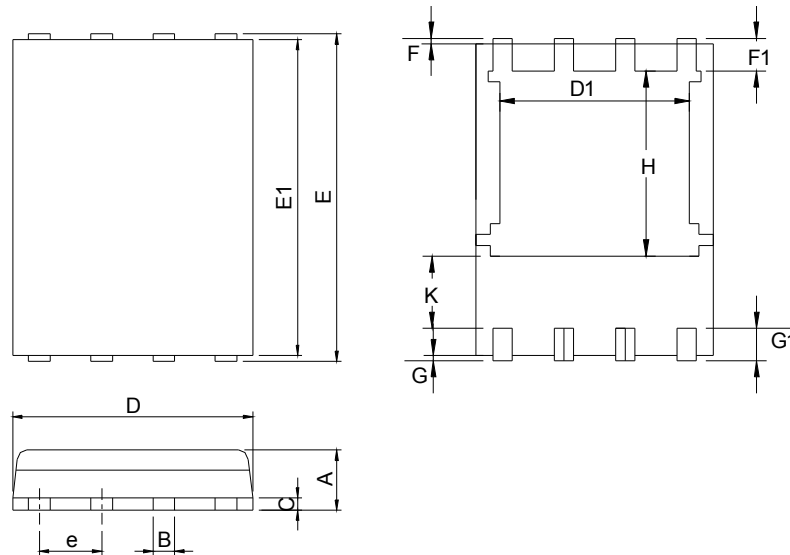

DIMENSIONS	DFN5x6-8			
	MILLIMETERS		INCHES	
	MIN.	MAX.	MIN.	MAX.
A	0.90	1.20	0.035	0.047
B	0.3	0.51	0.012	0.020
C	0.19	0.25	0.007	0.010
D	4.80	5.30	0.189	0.209
D1	4.00	4.40	0.157	0.173
E	5.90	6.20	0.232	0.244
E1	5.50	5.80	0.217	0.228
e	1.27 BSC		0.050 BSC	
F	0.05	0.30	0.002	0.012
F1	0.35	0.75	0.014	0.030
G	0.05	0.30	0.002	0.012
G1	0.35	0.75	0.014	0.030
H	3.34	3.9	0.131	0.154
K	0.762	-	0.03	-

### RECOMMENDED LAND PATTERN

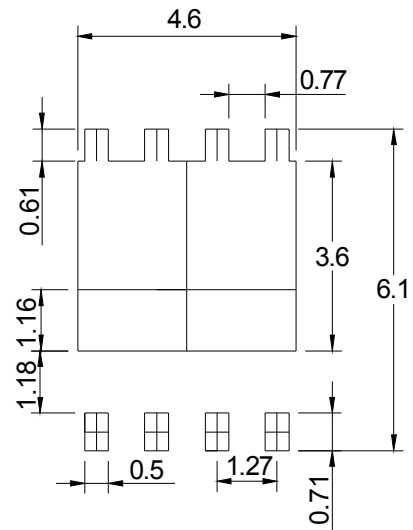

UNIT: mm

Note : 1.Dimension D, D1,D2 and E1 do not include mold flash or protrusions.  
Mold flash or protrusions shall not exceed 10 mil.



### Carrier Tape & Reel Dimensions

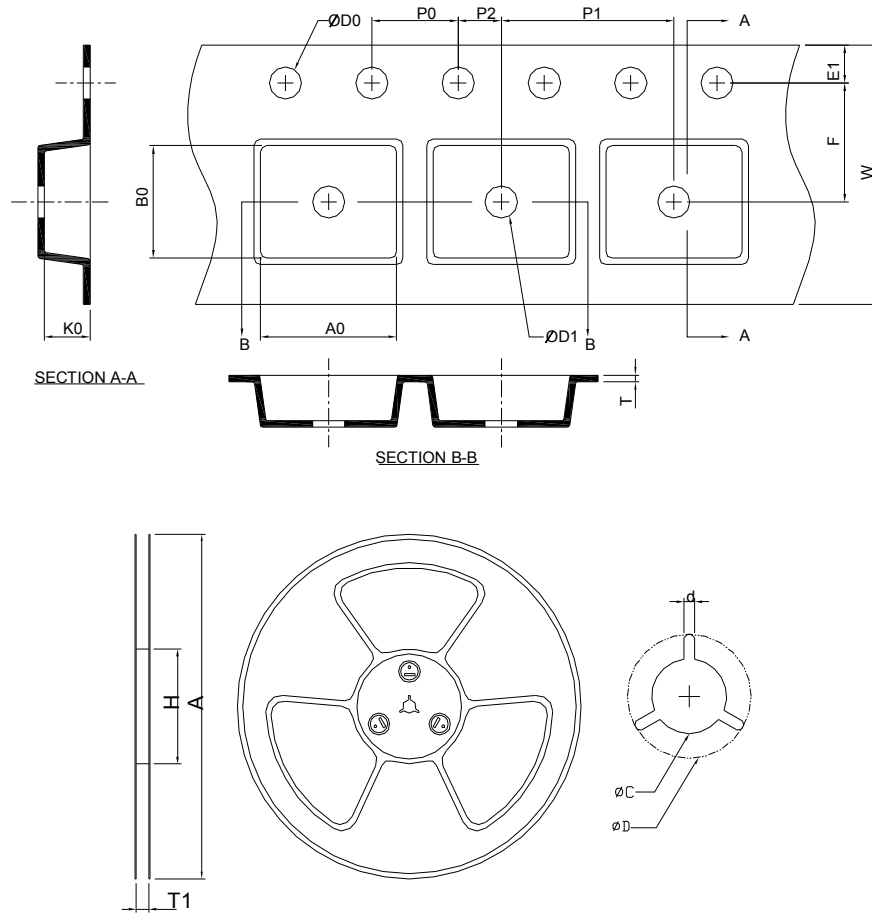

Application	A	H	T1	C	d	D	W	E1	F
DFN5x6-8	330.0±2.00	50 MIN.	12.4+2.00 -0.00	13.0+0.50 -0.20	1.5 MIN.	20.2 MIN.	12.0±0.30	1.75±0.10	5.5±0.05
	P0	P1	P2	D0	D1	T	A0	B0	K0
	4.0±0.10	8.0±0.10	2.0±0.05	1.5+0.10 -0.00	1.5 MIN.	0.6+0.00 -0.4	6.5±0.20	5.3±0.20	1.4±0.20

(mm)

## Taping Direction Information

DFN5x6-8

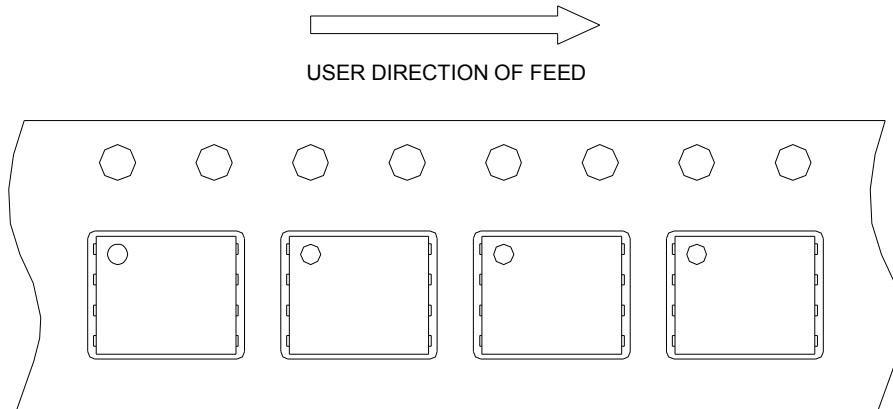

## Classification Profile



## Classification Reflow Profiles

Profile Feature	Sn-Pb Eutectic Assembly	Pb-Free Assembly
<b>Preheat &amp; Soak</b>		
Temperature min ( $T_{smin}$ )	100 °C	150 °C
Temperature max ( $T_{smax}$ )	150 °C	200 °C
Time ( $T_{smin}$ to $T_{smax}$ ) ( $t_s$ )	60-120 seconds	60-120 seconds
Average ramp-up rate ( $T_{smax}$ to $T_p$ )	3 °C/second max.	3°C/second max.
Liquidous temperature ( $T_L$ )	183 °C	217 °C
Time at liquidous ( $t_L$ )	60-150 seconds	60-150 seconds
Peak package body Temperature ( $T_p$ )*	See Classification Temp in table 1	See Classification Temp in table 2
Time ( $t_p$ )** within 5°C of the specified classification temperature ( $T_c$ )	20** seconds	30** seconds
Average ramp-down rate ( $T_p$ to $T_{smax}$ )	6 °C/second max.	6 °C/second max.
Time 25°C to peak temperature	6 minutes max.	8 minutes max.
* Tolerance for peak profile Temperature ( $T_p$ ) is defined as a supplier minimum and a user maximum. ** Tolerance for time at peak profile temperature ( $t_p$ ) is defined as a supplier minimum and a user maximum.		

Table 1. SnPb Eutectic Process – Classification Temperatures ( $T_c$ )

Package Thickness	Volume mm <sup>3</sup> <350	Volume mm <sup>3</sup> ≥350
<2.5 mm	235 °C	220 °C
≥2.5 mm	220 °C	220 °C

Table 2. Pb-free Process – Classification Temperatures ( $T_c$ )

Package Thickness	Volume mm <sup>3</sup> <350	Volume mm <sup>3</sup> 350-2000	Volume mm <sup>3</sup> >2000
<1.6 mm	260 °C	260 °C	260 °C
1.6 mm – 2.5 mm	260 °C	250 °C	245 °C
≥2.5 mm	250 °C	245 °C	245 °C

## Reliability Test Program

Test item	Method	Description
SOLDERABILITY	JESD-22, B102	5 Sec, 245°C
HTRB	JESD-22, A108	1000 Hrs, 80% of VDS max @ $T_{jmax}$
HTGB	JESD-22, A108	1000 Hrs, 100% of VGS max @ $T_{jmax}$
PCT	JESD-22, A102	168 Hrs, 100%RH, 2atm, 121°C
TCT	JESD-22, A104	500 Cycles, -65°C~150°C

## Customer Service

### Sinopower Semiconductor, Inc.

5F, No. 6, Dusing 1St Rd., Hsinchu Science Park,

Hsinchu, 30078, Taiwan

TEL: 886-3-5635818 Fax: 886-3-5642050