



SK1901

LINEAR INTEGRATED CIRCUIT

HALL-EFFECT SWITCH FOR HIGH-TEMPERATURE OPERATION

■ DESCRIPTION

SK1901 is a semiconductor integrated circuit utilizing the Hall effect. It has been so designed as to operate in the alternating magnetic field especially at low supply voltage and operation over extended temperature ranges to +125°C. This Hall IC is suitable for application to various kinds of sensors, contact-less switches, and the like.

■ FEATURES

- * Wide supply voltage range of 2.5V to 20V
- * Wide temperature operation range of -20°C~+125°C
- * TTL and MOS IC are directly drivable by the output
- * The life is semipermanent because it employs contact-less parts

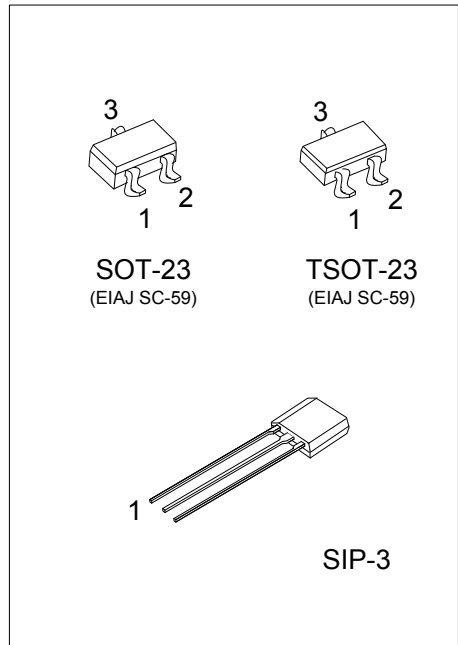

■ ORDERING INFORMATION

Ordering Number		Package	Pin Assignment			Packing
Lead Free	Halogen Free		1	2	3	
SK1901L-AE3-R	SK1901G-AE3-R	SOT-23	I	O	G	Tape Reel
SK1901L-AH3-R	SK1901G-AH3-R	TSOT-23	I	O	G	Tape Reel
SK1901L-G03-B	SK1901G-G03-B	SIP-3	I	G	O	Tape Box
SK1901L-G03-K	SK1901G-G03-K	SIP-3	I	G	O	Bulk

Note: Pin Assignment: I: V_{CC} O: V_{OUT} G: GND

<p>SK1901G-AE3-R</p> <p>(1) Packing Type (2) Package Type (3) Green Package</p>	<p>(1) R: Tape Reel, K: Bulk (2) AE3: SOT-23, AH3: TSOT-23, G03: SIP-3 (3) G: Halogen Free and Lead Free, L: Lead Free</p>
---	--

■ MARKING

SIP-3	SOT-23 / TSOT-23
<p>1901 □ □ □ □ □ □ □ □ □</p> <p>L: Lead Free G: Halogen Free Date Code</p>	<p>1901 □</p> <p>L: Lead Free G: Halogen Free</p>

■ BLOCK DIAGRAM

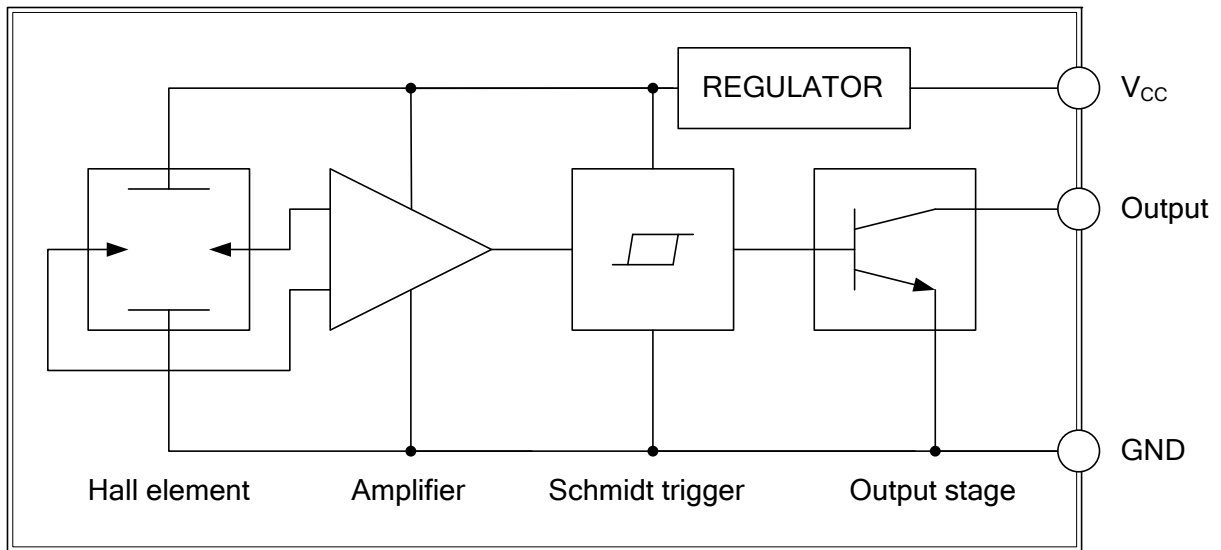

■ ABSOLUTE MAXIMUM RATINGS ($T_A = 25^\circ\text{C}$, unless otherwise specified)

PARAMETER		SYMBOL	RATINGS	UNIT
Supply voltage		V_{CC}	2.5 ~ 20	V
Supply current		I_{CC}	10	mA
Circuit current		I_o	20	mA
Power dissipation	SIP-3	P_D	400	mW
	SOT-23		200	mW
	TSOT-23		180	
Operating temperature		T_{OPR}	-20 ~ +125	$^\circ\text{C}$
Storage temperature		T_{STG}	-55 ~ +150	$^\circ\text{C}$

Note: Absolute maximum ratings are those values beyond which the device could be permanently damaged.
 Absolute maximum ratings are stress ratings only and functional device operation is not implied.

■ MAGNETIC CHARACTERISTICS (over operating supply voltage range.)

PARAMETER	SYMBOL	CONDITIONS	MIN	TYP	MAX	UNIT
Operate Point	B_{OP}	at $T_A = +25^\circ\text{C}$			100	G
Release Point	B_{RP}	at $T_A = +25^\circ\text{C}$	10			G
Hysteresis	B_{HYS}	at $T_A = +25^\circ\text{C}$		45		G

■ PACKAGE INFORMATION

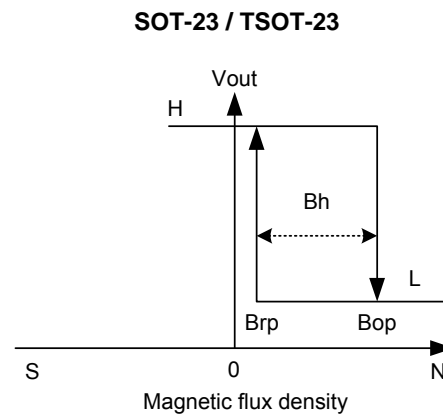
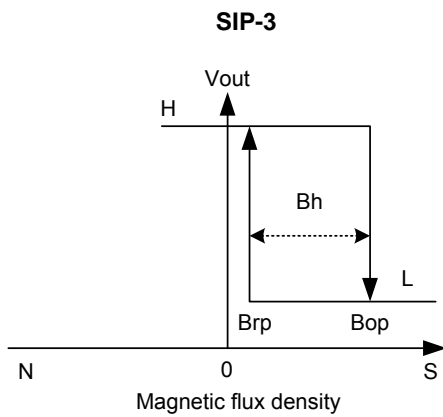
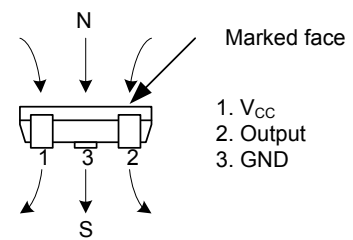
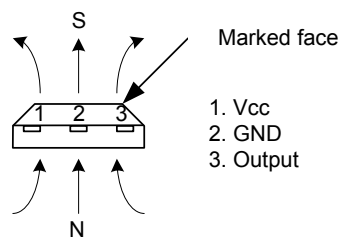
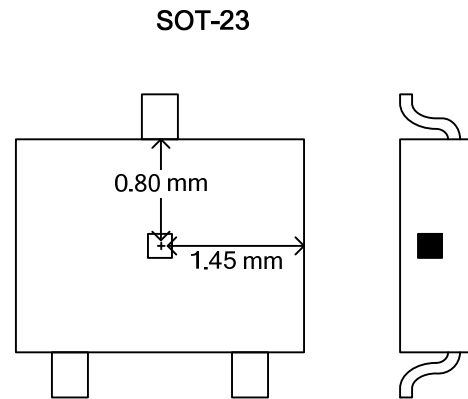
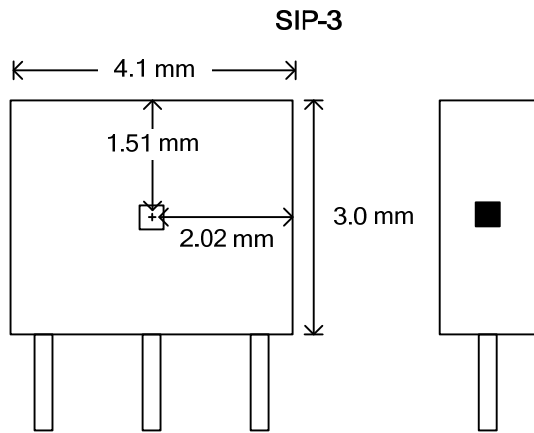

■ TYPICAL APPLICATION CIRCUIT

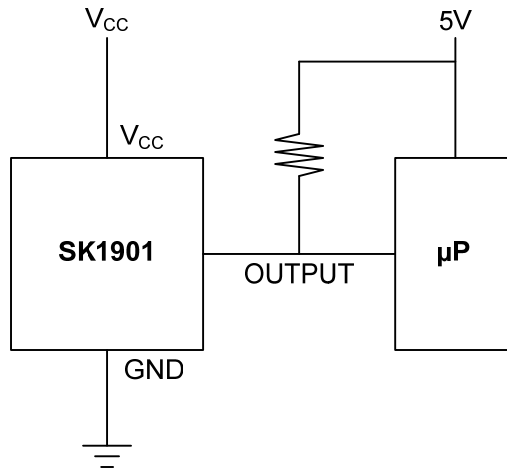

TYPICAL OPERATING CHARACTERISTICS

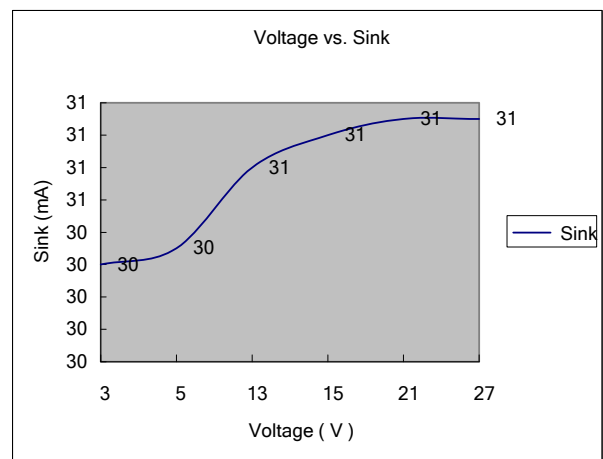
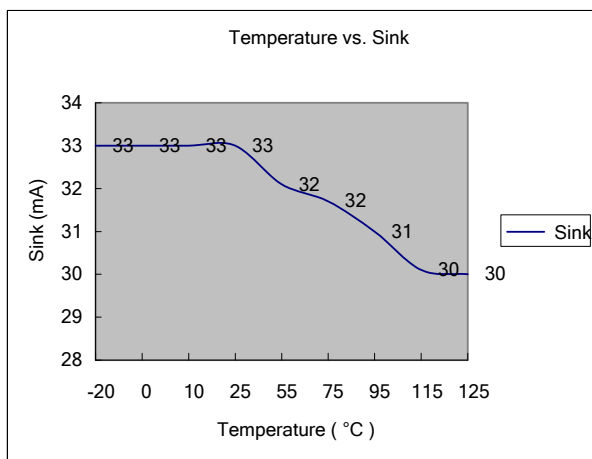
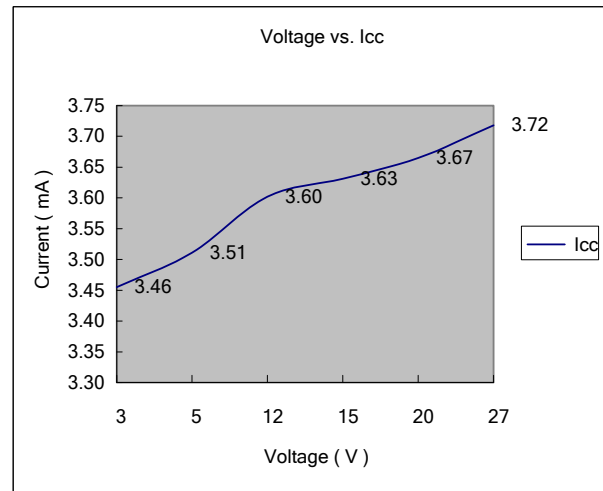
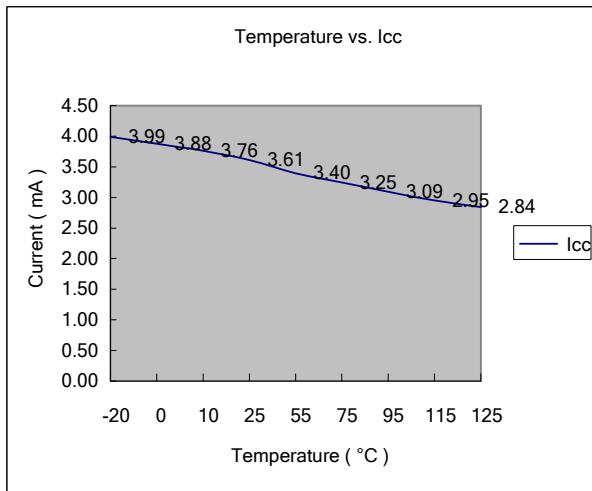
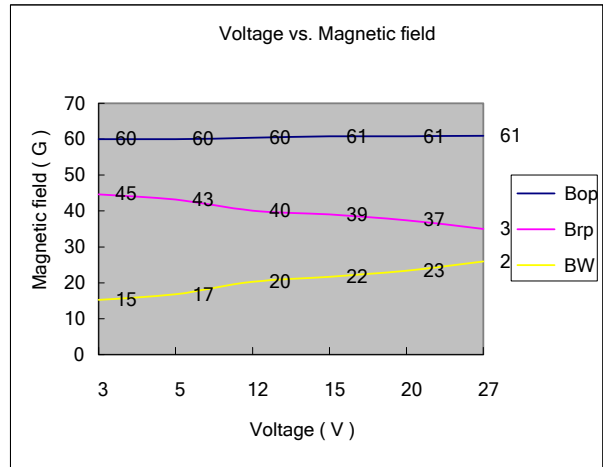
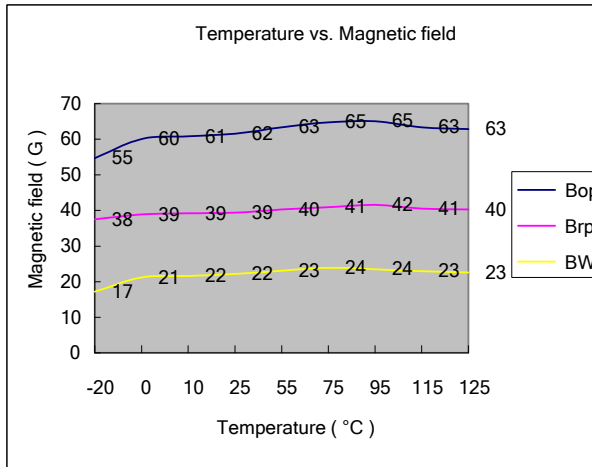

■ TYPICAL OPERATING CHARACTERISTICS (Cont.)

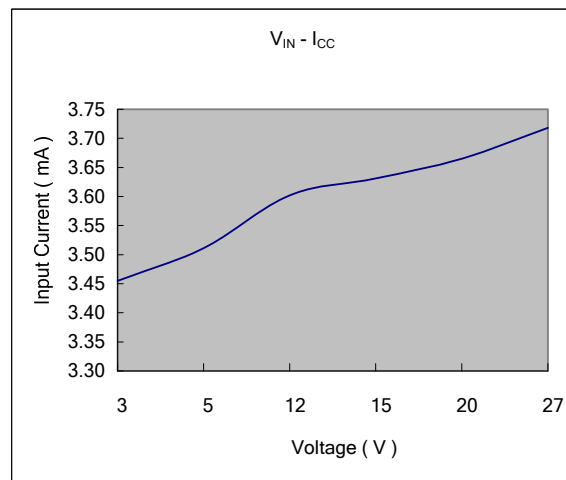
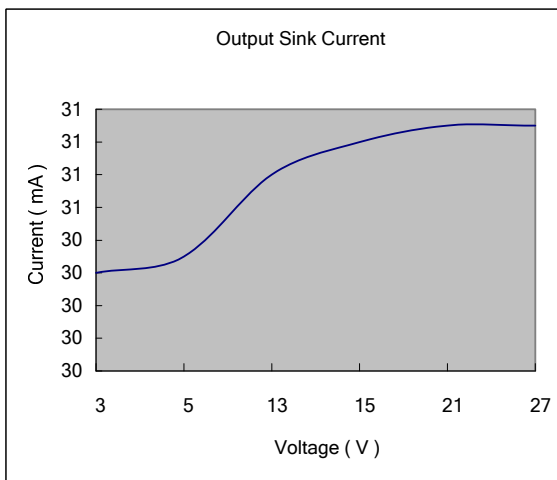
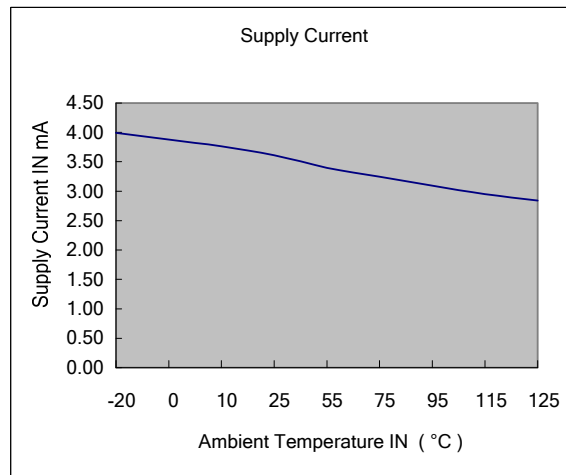
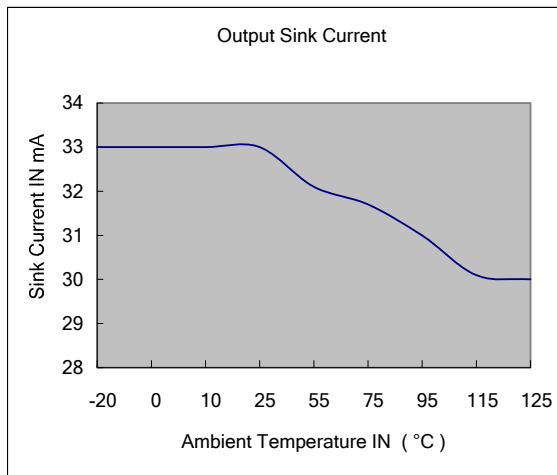
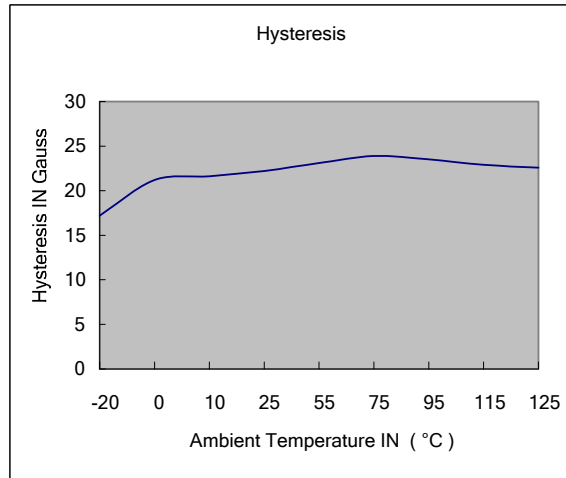
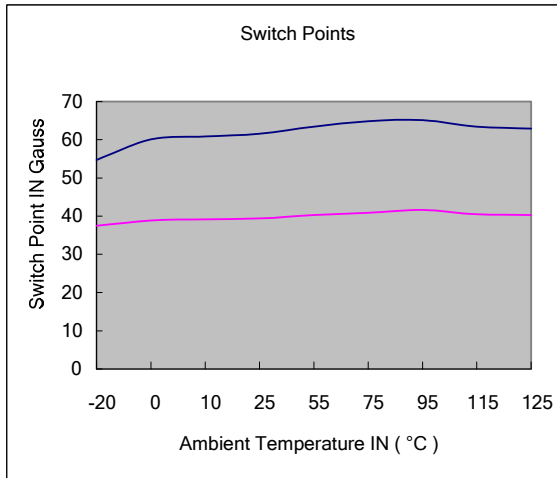

UTC assumes no responsibility for equipment failures that result from using products at values that exceed, even momentarily, rated values (such as maximum ratings, operating condition ranges, or other parameters) listed in products specifications of any and all UTC products described or contained herein. UTC products are not designed for use in life support appliances, devices or systems where malfunction of these products can be reasonably expected to result in personal injury. Reproduction in whole or in part is prohibited without the prior written consent of the copyright owner. UTC reserves the right to make changes to information published in this document, including without limitation specifications and product descriptions, at any time and without notice. This document supersedes and replaces all information supplied prior to the publication hereof.