

## Dual P-Channel 12-V (D-S) MOSFET

PRODUCT SUMMARY		
$V_{DS}$ (V)	$r_{DS(on)}$ ( $\Omega$ )	$I_D$ (A)
-12	0.037 @ $V_{GS} = -4.5$ V	-7.7
	0.048 @ $V_{GS} = -2.5$ V	-6.8
	0.068 @ $V_{GS} = -1.8$ V	-5.7

### FEATURES

- TrenchFET<sup>®</sup> Power MOSFETS: 1.8-V Rated
- New Low Thermal Resistance PowerPAK<sup>®</sup> Package
- Advanced High Cell Density Process
- Ultra-Low  $r_{DS(on)}$ , and High  $P_D$  Capability



**RoHS\***  
COMPLIANT

### APPLICATIONS

- Load Switch
- PA Switch
- Battery Switch
- Bi-Directional Switch

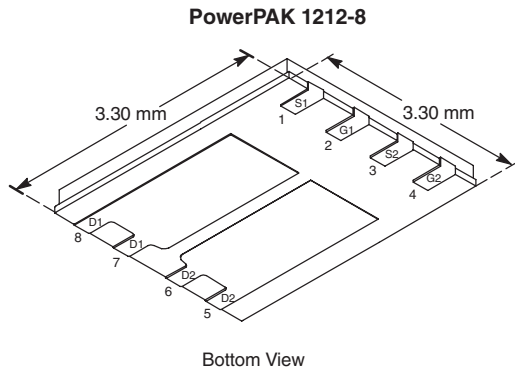

**Ordering Information:** Si7909DN-T1  
Si7909DN-T1-E3 (Lead (Pb)-free)

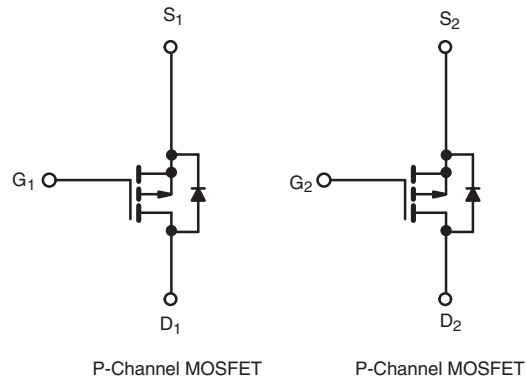

ABSOLUTE MAXIMUM RATINGS $T_A = 25^\circ\text{C}$ , unless otherwise noted					
Parameter		Symbol	10 secs	Steady State	Unit
Drain-Source Voltage		$V_{DS}$	-12		V
Gate-Source Voltage		$V_{GS}$	$\pm 8$		
Continuous Drain Current ( $T_J = 150^\circ\text{C}$ ) <sup>a</sup>	$T_A = 25^\circ\text{C}$	$I_D$	-7.7	-5.3	A
	$T_A = 85^\circ\text{C}$		-5.5	-3.8	
Pulsed Drain Current		$I_{DM}$	-20		A
Continuous Source Current (Diode Conduction) <sup>a</sup>		$I_S$	-2.3	-1.1	
Maximum Power Dissipation <sup>a</sup>	$T_A = 25^\circ\text{C}$	$P_D$	2.8	1.3	W
	$T_A = 85^\circ\text{C}$		1.5	0.85	
Operating Junction and Storage Temperature Range		$T_J, T_{stg}$	-55 to 150		$^\circ\text{C}$
Soldering Recommendations (Peak Temperature) <sup>b,c</sup>			260		

THERMAL RESISTANCE RATINGS					
Parameter		Symbol	Typical	Maximum	Unit
Maximum Junction-to-Ambient <sup>a</sup>	$t \leq 10$ sec	$R_{thJA}$	35	44	$^\circ\text{C}/\text{W}$
	Steady State		75	94	
Maximum Junction-to-Case		$R_{thJC}$	4	5	

**Notes**

- Surface Mounted on 1" x 1" FR4 Board.
- See Solder Profile (<http://www.vishay.com/ppg?73257>). The PowerPAK 1212-8 is a leadless package. The end of the lead terminal is exposed copper (not plated) as a result of the singulation process in manufacturing. A solder fillet at the exposed copper tip cannot be guaranteed and is not required to ensure adequate bottom side solder interconnection.
- Rework Conditions: manual soldering with a soldering iron is not recommended for leadless components.

\* Pb containing terminations are not RoHS compliant, exemptions may apply



<b>SPECIFICATIONS</b> $T_J = 25^\circ\text{C}$ , unless otherwise noted						
Parameter	Symbol	Test Condition	Min	Typ	Max	Unit
<b>Static</b>						
Gate Threshold Voltage	$V_{GS(th)}$	$V_{DS} = V_{GS}, I_D = -700 \mu\text{A}$	-0.40		-1.0	V
Gate-Body Leakage	$I_{GSS}$	$V_{DS} = 0 \text{ V}, V_{GS} = \pm 8 \text{ V}$			$\pm 100$	nA
Zero Gate Voltage Drain Current	$I_{DSS}$	$V_{DS} = -12 \text{ V}, V_{GS} = 0 \text{ V}$			-1	$\mu\text{A}$
		$V_{DS} = -12 \text{ V}, V_{GS} = 0 \text{ V}, T_J = 85^\circ\text{C}$			-5	
On-State Drain Current <sup>a</sup>	$I_{D(on)}$	$V_{DS} \leq -5 \text{ V}, V_{GS} = -4.5 \text{ V}$	-20			A
Drain-Source On-State Resistance <sup>a</sup>	$r_{DS(on)}$	$V_{GS} = -4.5 \text{ V}, I_D = -7.7 \text{ A}$		0.031	0.037	$\Omega$
		$V_{GS} = -2.5 \text{ V}, I_D = -6.8 \text{ A}$		0.040	0.048	
		$V_{GS} = -1.8 \text{ V}, I_D = -3.0 \text{ A}$		0.057	0.068	
Forward Transconductance <sup>a</sup>	$g_{fs}$	$V_{DS} = -6 \text{ V}, I_D = -7.7 \text{ A}$		17		S
Diode Forward Voltage <sup>a</sup>	$V_{SD}$	$I_S = -2.3 \text{ A}, V_{GS} = 0 \text{ V}$		-0.7	-1.2	V
<b>Dynamic<sup>b</sup></b>						
Total Gate Charge	$Q_g$	$V_{DS} = -6 \text{ V}, V_{GS} = -4.5 \text{ V}, I_D = -7.7 \text{ A}$		15.5	24	nC
Gate-Source Charge	$Q_{gs}$		2.5			
Gate-Drain Charge	$Q_{gd}$		4.3			
Turn-On Delay Time	$t_{d(on)}$	$V_{DD} = -6 \text{ V}, R_L = 6 \Omega$ $I_D \cong -1 \text{ A}, V_{GEN} = -4.5 \text{ V}, R_G = 6 \Omega$		25	40	ns
Rise Time	$t_r$		45	70		
Turn-Off Delay Time	$t_{d(off)}$		90	135		
Fall Time	$t_f$		85	130		
Source-Drain Reverse Recovery Time	$t_{rr}$		$I_F = -2.3 \text{ A}, di/dt = 100 \text{ A}/\mu\text{s}$		70	

Notes

- a. Pulse test; pulse width  $\leq 300 \mu\text{s}$ , duty cycle  $\leq 2\%$ .
- b. Guaranteed by design, not subject to production testing.

Stresses beyond those listed under "Absolute Maximum Ratings" may cause permanent damage to the device. These are stress ratings only, and functional operation of the device at these or any other conditions beyond those indicated in the operational sections of the specifications is not implied. Exposure to absolute maximum rating conditions for extended periods may affect device reliability.

**TYPICAL CHARACTERISTICS**  $T_A = 25^\circ\text{C}$ , unless otherwise noted

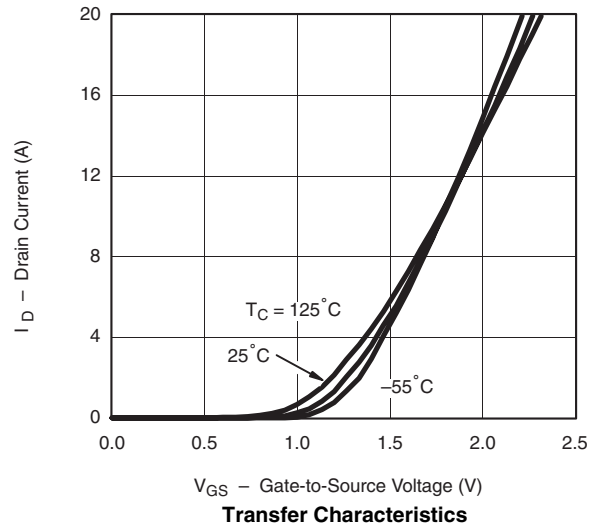
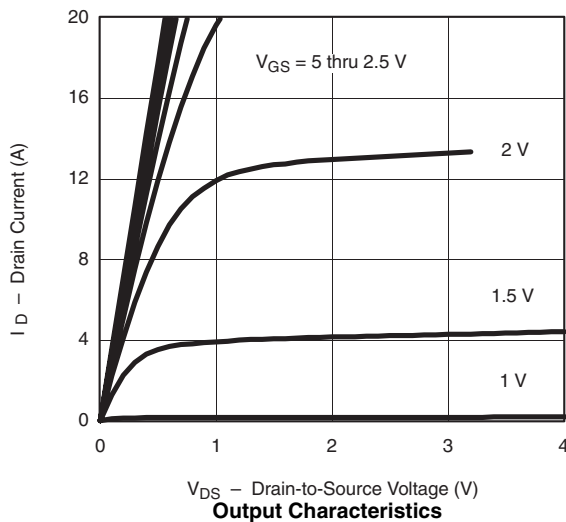

**TYPICAL CHARACTERISTICS**  $T_A = 25^\circ\text{C}$ , unless otherwise noted

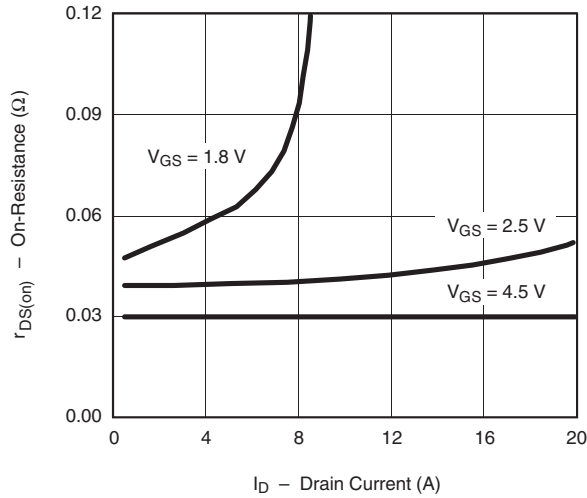

**On-Resistance vs. Drain Current**

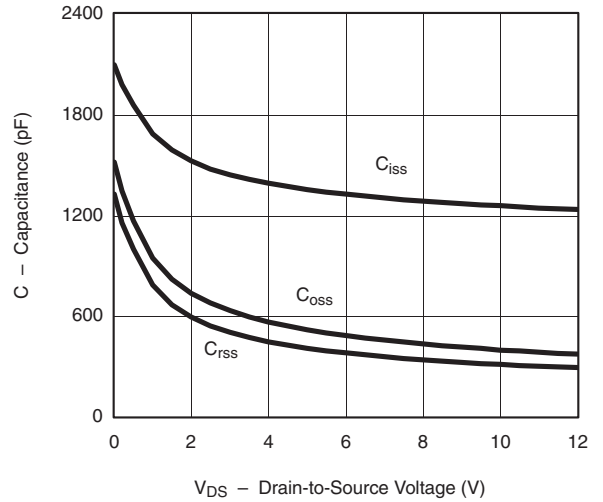

**Capacitance**

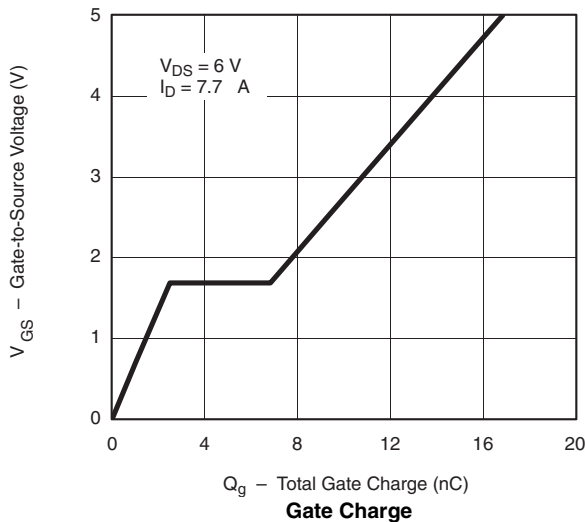

**Gate Charge**

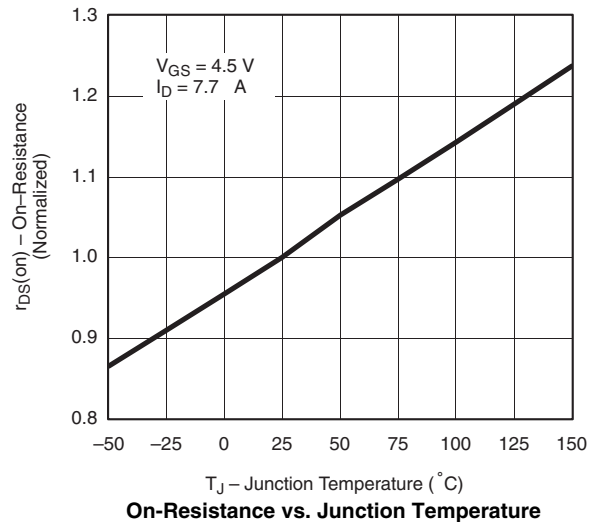

**On-Resistance vs. Junction Temperature**

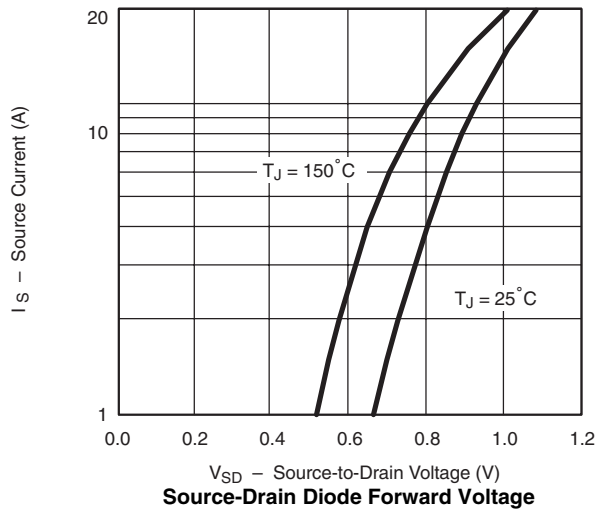

**Source-Drain Diode Forward Voltage**

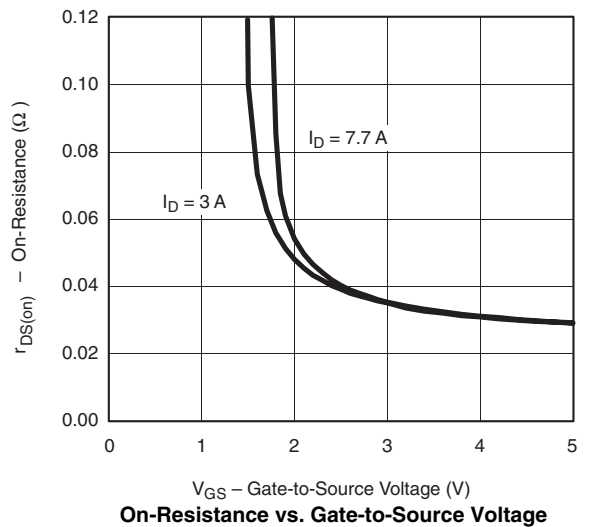

**On-Resistance vs. Gate-to-Source Voltage**



**TYPICAL CHARACTERISTICS**  $T_A = 25^\circ\text{C}$ , unless otherwise noted

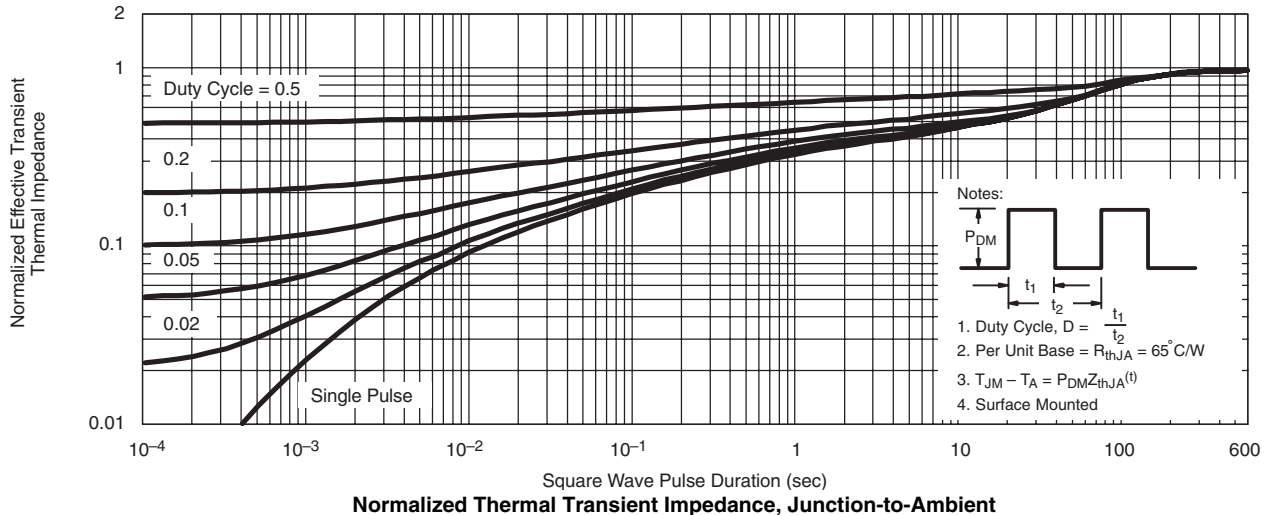
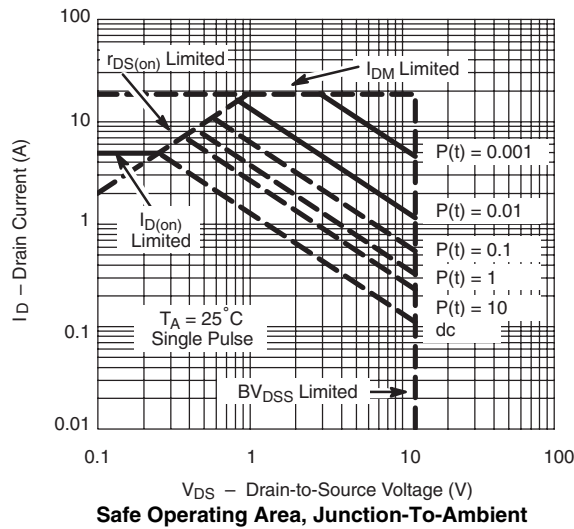
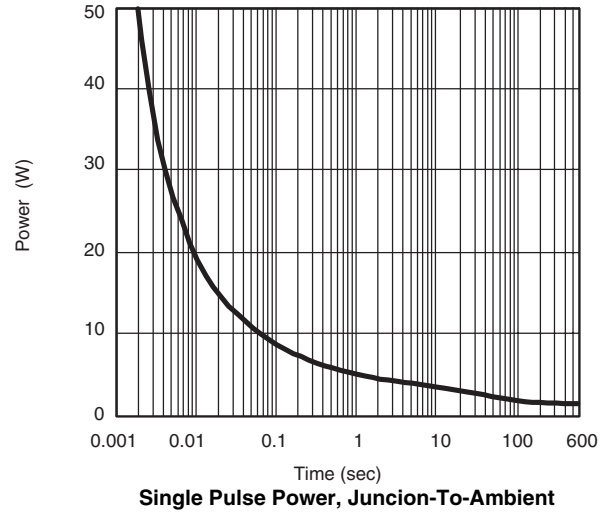
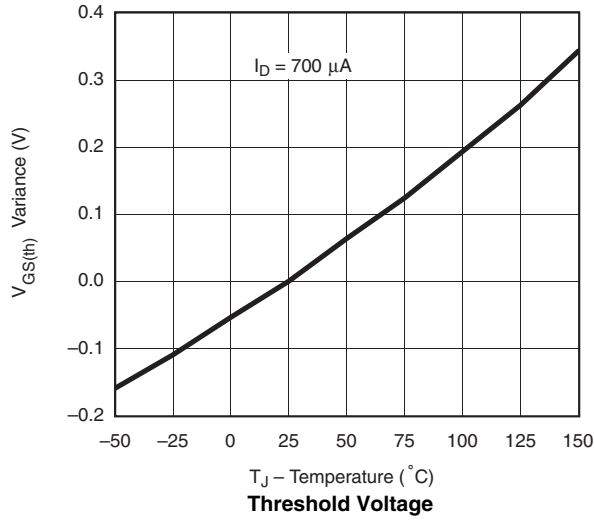



**TYPICAL CHARACTERISTICS**  $T_A = 25^\circ\text{C}$ , unless otherwise noted

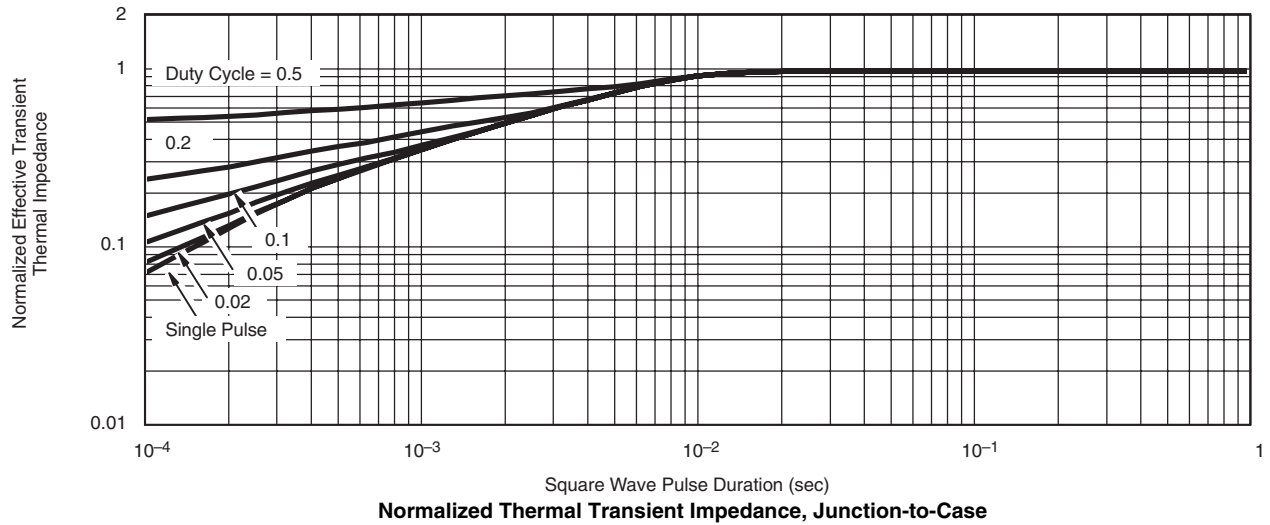

Vishay Siliconix maintains worldwide manufacturing capability. Products may be manufactured at one of several qualified locations. Reliability data for Silicon Technology and Package Reliability represent a composite of all qualified locations. For related documents such as package/tape drawings, part marking, and reliability data, see <http://www.vishay.com/ppg?71996>.