

Features

- -20V/-4A,
 $R_{DS(ON)} = 35m\Omega(Typ.)@V_{GS} = -4.5V$
 $R_{DS(ON)} = 45m\Omega(Typ.)@V_{GS} = -2.5V$
- Low On-Resistance
- Super High Dense Cell Design
- Reliable and Rugged
- Lead Free and Green Devices Available (RoHS Compliant)

Applications

- Load Switch
- Power Management
- Battery Protection

Pin Description

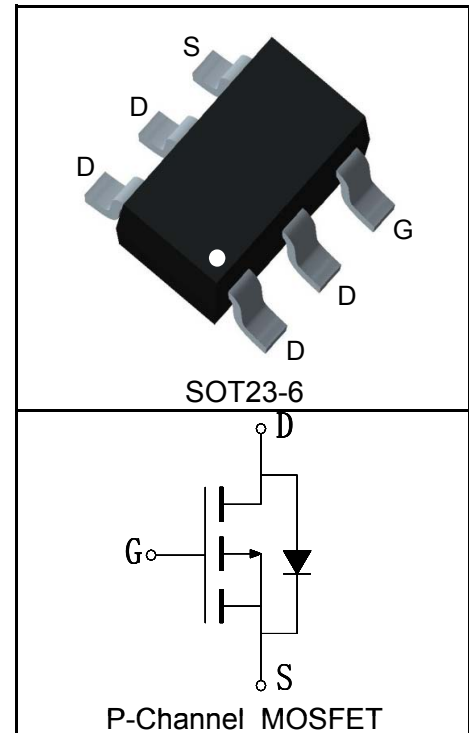

Absolute Maximum Ratings

Symbol	Parameter	Rating	Unit	
Common Ratings ($T_A = 25^\circ C$ Unless Otherwise Noted)				
V_{DSS}	Drain-Source Voltage	-20	V	
V_{GSS}	Gate-Source Voltage	± 10		
T_J	Maximum Junction Temperature	150	$^\circ C$	
T_{STG}	Storage Temperature Range	-55 to 150	$^\circ C$	
I_S	Diode Continuous Forward Current	$T_A = 25^\circ C$	-1.2	A
Mounted on Large Heat Sink				
$I_{DP}^{①}$	300 μs Pulse Drain Current Tested	$T_A = 25^\circ C$	-16	A
$I_D^{②}$	Continuous Drain Current ($V_{GS} = -10V$)	$T_A = 25^\circ C$	-4	A
		$T_A = 70^\circ C$	-3.2	
P_D	Maximum Power Dissipation	$T_A = 25^\circ C$	1.3	W
		$T_A = 70^\circ C$	0.8	
$R_{\theta JC}$	Thermal Resistance-Junction to Case	-	$^\circ C/W$	
$R_{\theta JA}^{③}$	Thermal Resistance-Junction to Ambient	100	$^\circ C/W$	
Drain-Source Avalanche Ratings				
$E_{AS}^{④}$	Avalanche Energy, Single Pulsed	TBD	mJ	

Electrical Characteristics ($T_A=25^\circ\text{C}$ Unless Otherwise Noted)

Symbol	Parameter	Test Condition	RU20P4C6			Unit
			Min.	Typ.	Max.	
Static Characteristics						
BV_{DSS}	Drain-Source Breakdown Voltage	$V_{GS}=0V, I_{DS}=-250\mu A$	-20			V
I_{DSS}	Zero Gate Voltage Drain Current	$V_{DS}=-20V, V_{GS}=0V$			-1	μA
		$T_J=125^\circ C$			-30	
$V_{GS(th)}$	Gate Threshold Voltage	$V_{DS}=V_{GS}, I_{DS}=-250\mu A$	-0.4		-1.1	V
I_{GSS}	Gate Leakage Current	$V_{GS}=\pm 10V, V_{DS}=0V$			± 100	nA
$R_{DS(ON)}^{(5)}$	Drain-Source On-state Resistance	$V_{GS}=-4.5V, I_{DS}=-4A$		35	60	$m\Omega$
		$V_{GS}=-2.5V, I_{DS}=-3.2A$		45	100	$m\Omega$
Diode Characteristics						
$V_{SD}^{(5)}$	Diode Forward Voltage	$I_{SD}=-1A, V_{GS}=0V$			-1.2	V
t_{rr}	Reverse Recovery Time	$I_{SD}=-4A, dI_{SD}/dt=100A/\mu s$		15		ns
Q_{rr}	Reverse Recovery Charge			21		nC
Dynamic Characteristics ⁽⁶⁾						
R_G	Gate Resistance	$V_{GS}=0V, V_{DS}=0V, F=1MHz$		0.9		Ω
C_{iss}	Input Capacitance	$V_{GS}=0V,$ $V_{DS}=-10V,$ Frequency=1.0MHz		630		pF
C_{oss}	Output Capacitance			125		
C_{rss}	Reverse Transfer Capacitance			65		
$t_{d(ON)}$	Turn-on Delay Time	$V_{DD}=-10V, I_{DS}=-4A,$ $V_{GEN}=-4.5V, R_G=6\Omega$		9		ns
t_r	Turn-on Rise Time			16		
$t_{d(OFF)}$	Turn-off Delay Time			45		
t_f	Turn-off Fall Time			21		
Gate Charge Characteristics ⁽⁶⁾						
Q_g	Total Gate Charge	$V_{DS}=-16V, V_{GS}=-4.5V,$ $I_{DS}=-4A$		10		nC
Q_{gs}	Gate-Source Charge			1.8		
Q_{gd}	Gate-Drain Charge			2.9		

- Notes:
- ① Pulse width limited by safe operating area.
 - ② Calculated continuous current based on maximum allowable junction temperature.
 - ③ When mounted on 1 inch square copper board, $t \leq 10\text{sec}$. The value in any given application depends on the user's specific board design.
 - ④ Limited by T_{Jmax} . Starting $T_J = 25^\circ\text{C}$.
 - ⑤ Pulse test; Pulse width $\leq 300\mu s$, duty cycle $\leq 2\%$.
 - ⑥ Guaranteed by design, not subject to production testing.

Ordering and Marking Information

Device	Marking^①	Package	Packaging	Quantity	Reel Size	Tape width
RU20P4C6	KXYWW	SOT23-6	Tape&Reel	3000	7"	8mm

① The following characters could be different and means:

X =Assembly site code

Y =Year

WW =Work Week

Typical Characteristics

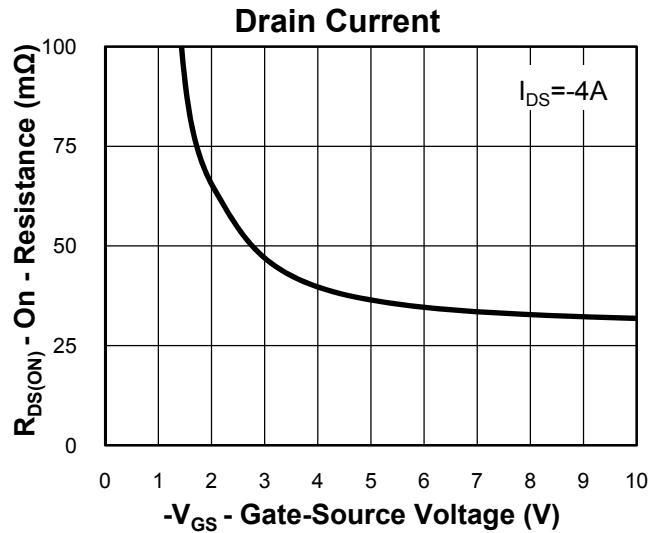
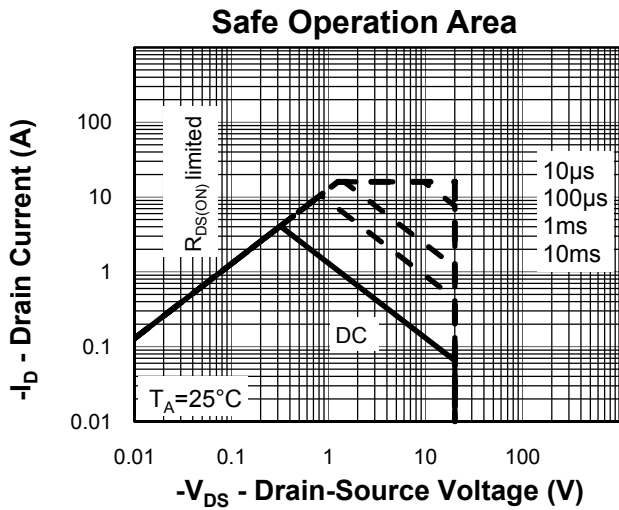
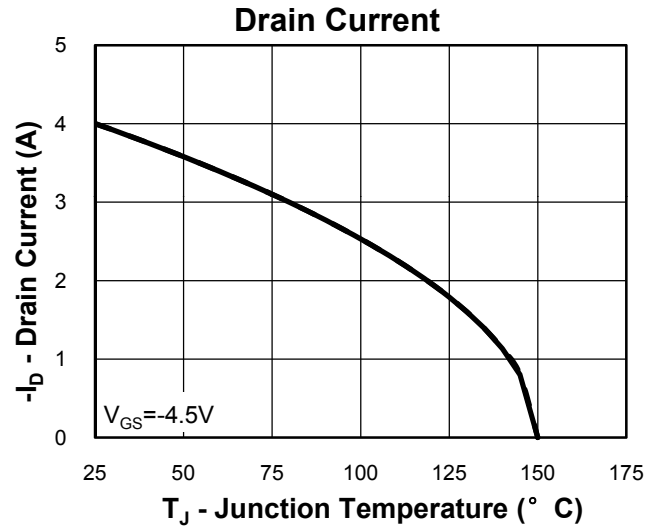
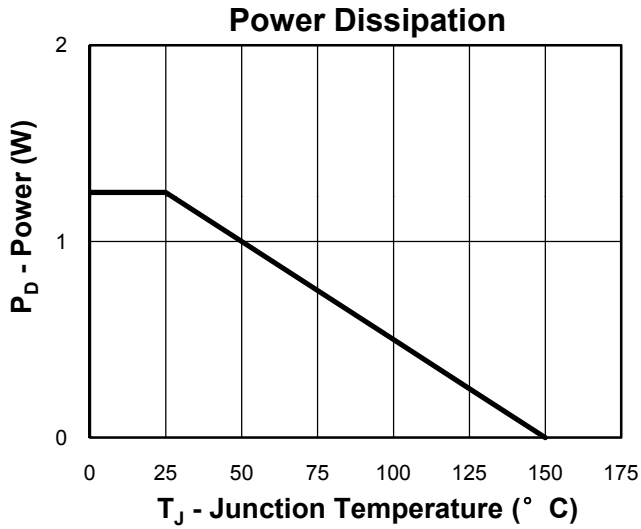

Thermal Transient Impedance

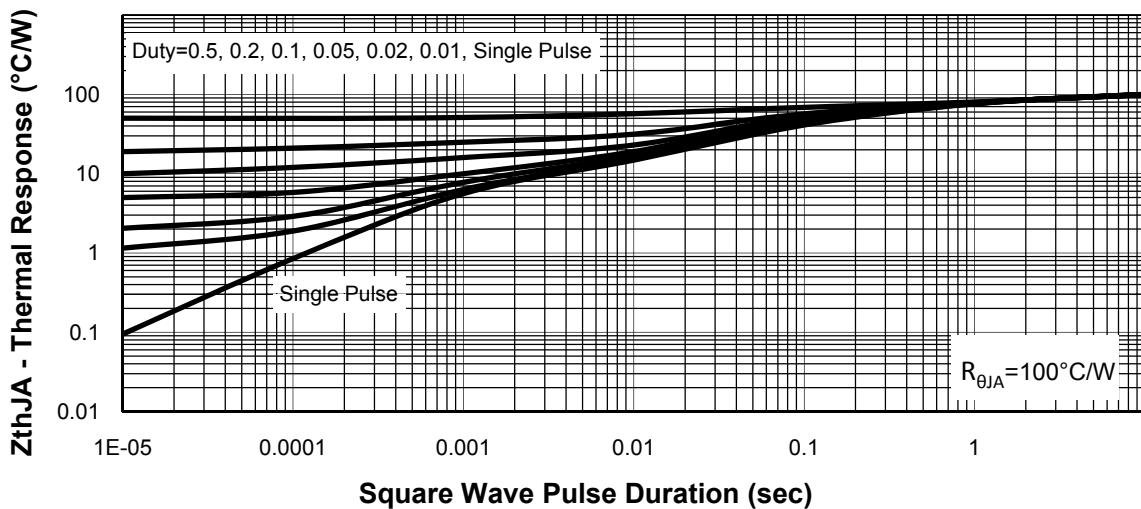

Typical Characteristics

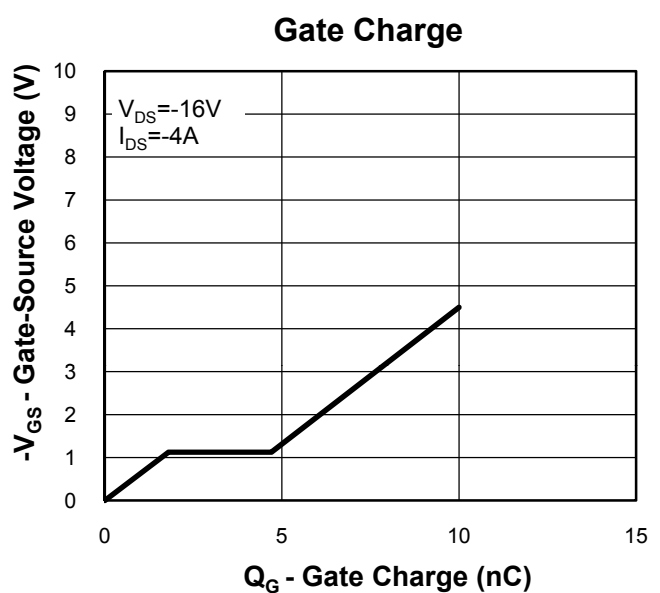
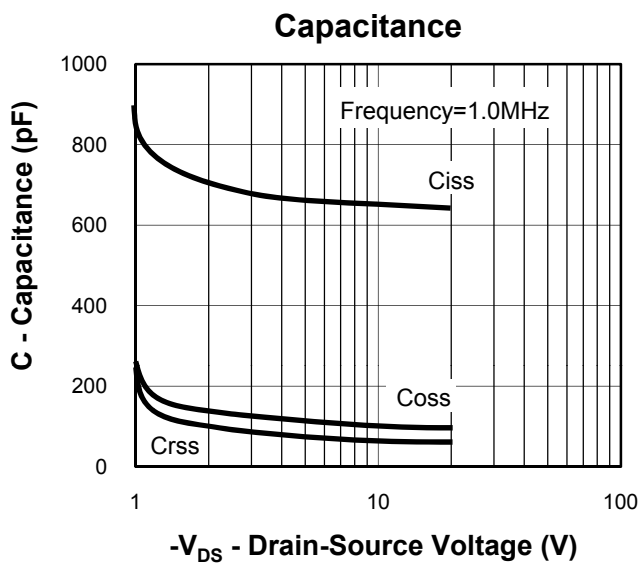
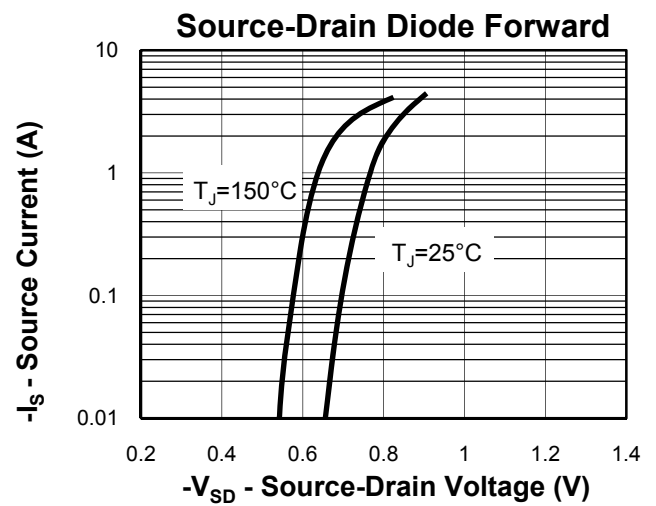
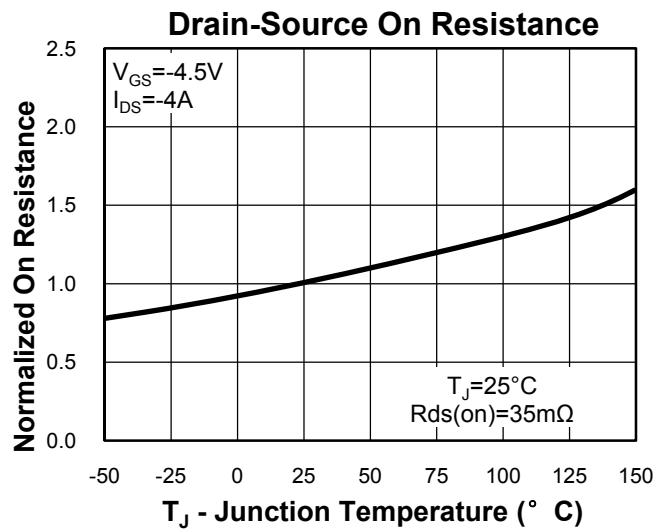
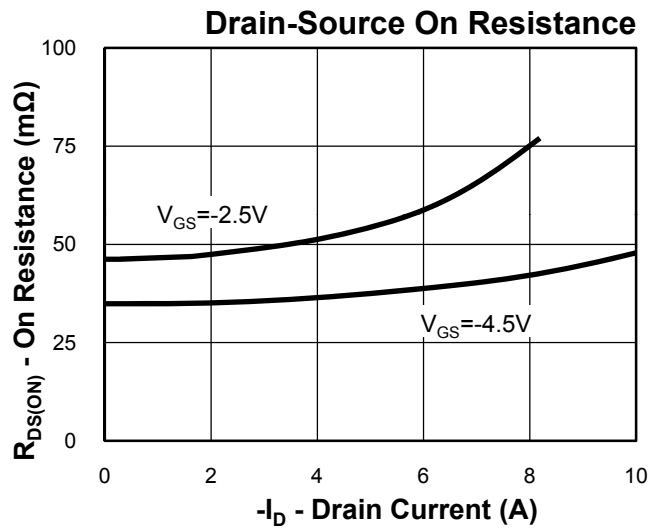
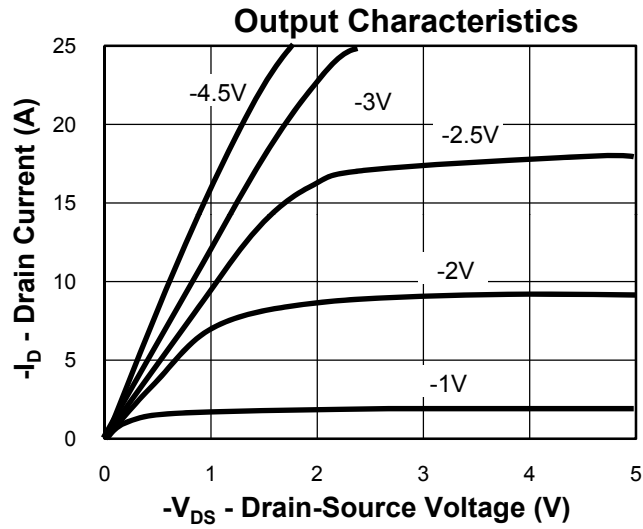

Avalanche Test Circuit and Waveforms

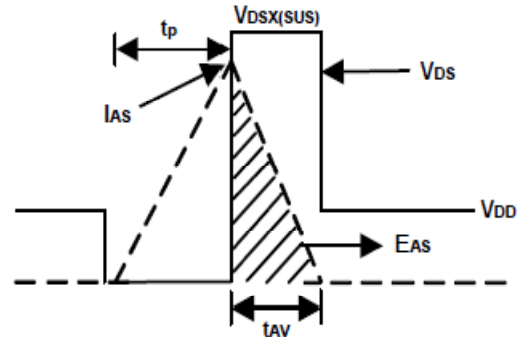
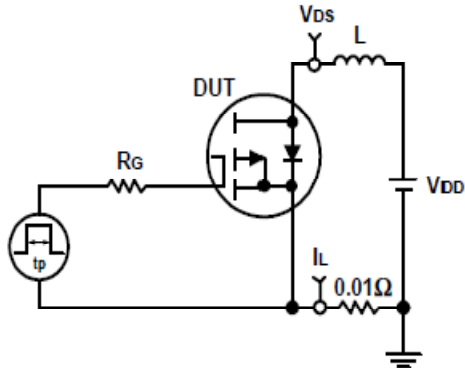

Switching Time Test Circuit and Waveforms

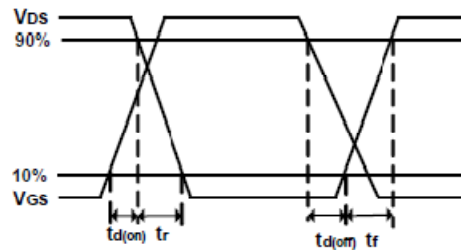
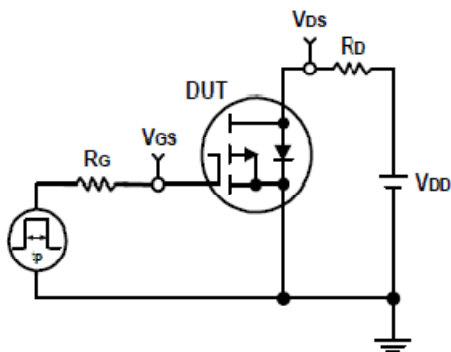

Package Information

SOT23-6

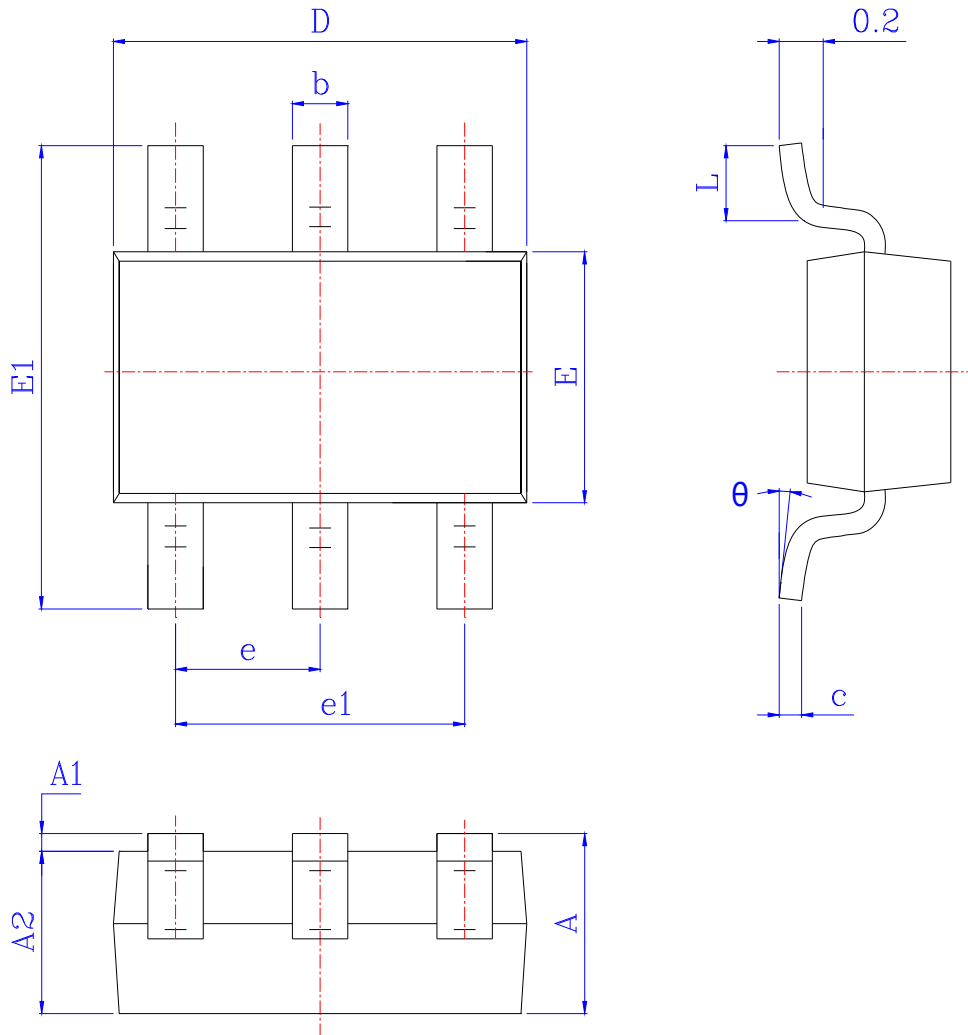

SYMBOL	MM			INCH		
	MIN	NOM	MAX	MIN	NOM	MAX
A	0.950	1.150	1.450	0.037	0.045	0.057
A1	0.000	0.060	0.150	0.000	0.002	0.006
A2	0.900	1.100	1.300	0.035	0.043	0.051
b	0.300	0.400	0.500	0.012	0.016	0.020
c	0.080	0.140	0.200	0.003	0.006	0.008
D	2.800	2.900	3.050	0.110	0.114	0.120
E	1.500	1.600	1.750	0.059	0.063	0.069
E1	2.600	2.800	3.000	0.102	0.110	0.118
e	0.950BSC			0.037BSC		
e1	1.800	1.900	2.000	0.071	0.075	0.079
L	0.300	0.450	0.600	0.012	0.018	0.024
θ	0°	4°	8°	0°	4°	8°

Customer Service

Worldwide Sales and Service:
Sales@ruichips.com

Technical Support:
Technical@ruichips.com

Investor Relations Contacts:
Investor@ruichips.com

Marcom Contact:
Marcom@ruichips.com

Editorial Contact:
Editorial@ruichips.com

HR Contact:
HR@ruichips.com

Legal Contact:
Legal@ruichips.com

Shen Zhen RUICHIPS Semiconductor CO., LTD
4th Floor, Block 8, Changyuan New Material Port, Keyuan Middle Road, Science & Industry Park,
Nanshan District, Shenzhen, CHINA

TEL: (86-755) 8311-5334
FAX: (86-755) 8311-4278
E-mail: Sales-SZ@ruichips.com