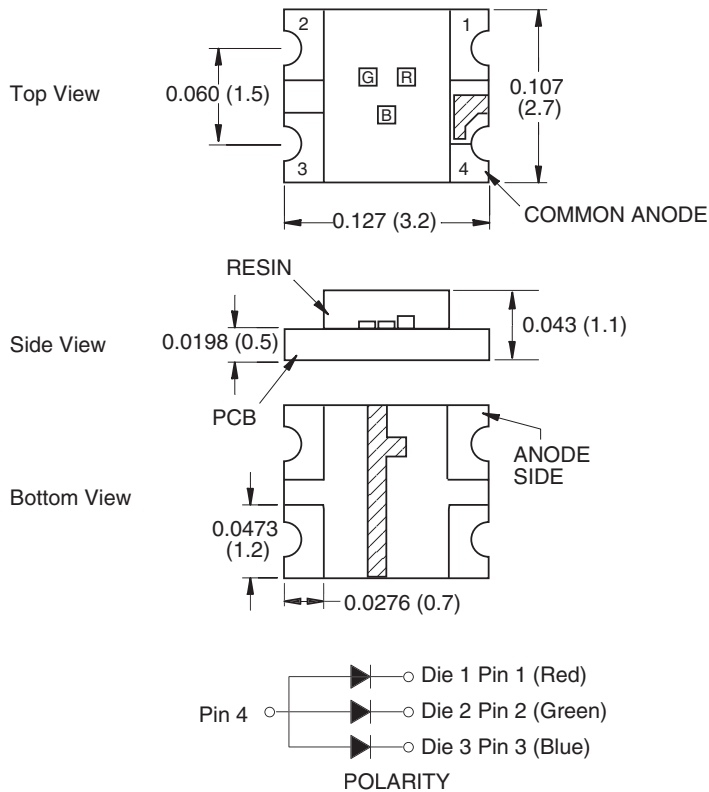
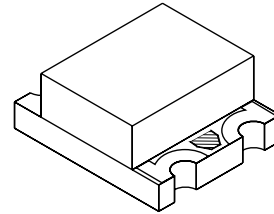


### QTLP650D-RGB Red/Green/Blue

#### PACKAGE DIMENSIONS



**NOTE:**  
Dimensions for all drawings are in inches (mm).



#### APPLICATIONS

- Keypad backlighting
- Push-button backlighting
- LCD backlighting

#### DESCRIPTION

This full-color surface mount chip LED is designed to fit industry standard footprint. Small size, low profile and wide viewing angle make this LED ideal for backlighting applications and panel illumination.

#### FEATURES

- Miniature footprint - 3.2(L) X 2.7(W) X 1.1(H) mm
- AllnGaP and InGaN technology
- Wide viewing angle of 140°
- Diffused optics
- Moisture-proof packaging
- Available in 0.315" (8mm) width tape on 7" (178mm) diameter reel; 2,000 units per reel

**QTLP650D-RGB Red/Green/Blue**

**ABSOLUTE MAXIMUM RATINGS** ( $T_A = 25^\circ\text{C}$  Unless otherwise specified)

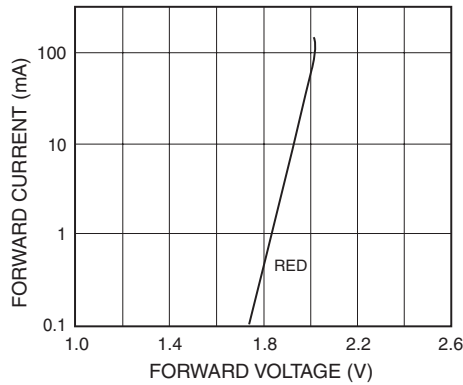
Parameter	Symbol	R	G	B	Units
Continuous Forward Current	$I_F$	30	20	20	mA
Peak Forward Current ( $f = 1.0 \text{ KHz}$ , Duty Factor = 1/10)	$I_{FM}$	100	80	80	mA
Reverse Voltage ( $I_R = 100 \mu\text{A}$ )	$V_R$	5			V
Power Dissipation	$P_D$	72	78	78	mW
Operating Temperature	$T_{OPR}$	-30 to +80			$^\circ\text{C}$
Storage Temperature	$T_{STG}$	-40 to +85			$^\circ\text{C}$
Lead Soldering Time	$T_{SOL}$	260 for 5 sec			$^\circ\text{C}$

**ELECTRICAL / OPTICAL CHARACTERISTICS** ( $T_A = 25^\circ\text{C}$ )

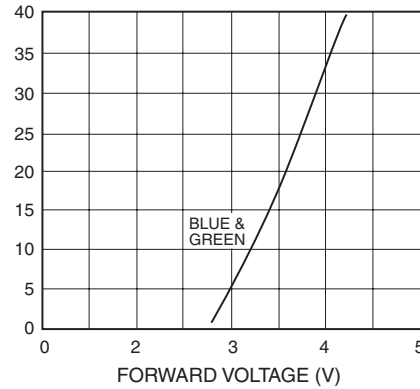
Parameter	Symbol	QTLP650D			Condition
		R	G	B	
Luminous Intensity (mcd)	min:	25	63	25	$I_F = 20\text{mA}$
	typ:	60	130	40	
Forward Voltage (V)	typ:	1.9	3.3	3.3	$I_F = 20\text{mA}$
	max:	2.4	3.9	3.9	
Wavelength (nm)	Peak:	630	520	468	$I_F = 20\text{mA}$
	Dominance:	624	525	470	
Typical Viewing Angle ( $^\circ$ )	2U1/2	140			$I_F = 20\text{mA}$

**TYPICAL PERFORMANCE CURVES**

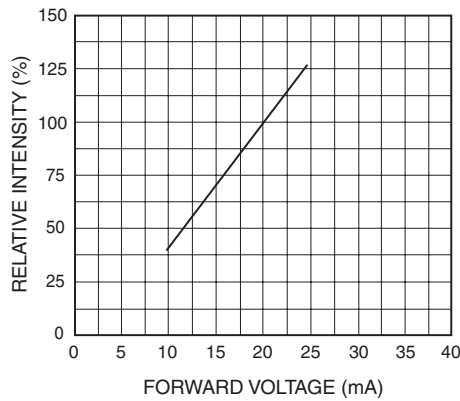
**Fig. 1A Forward Current vs. Forward Voltage**



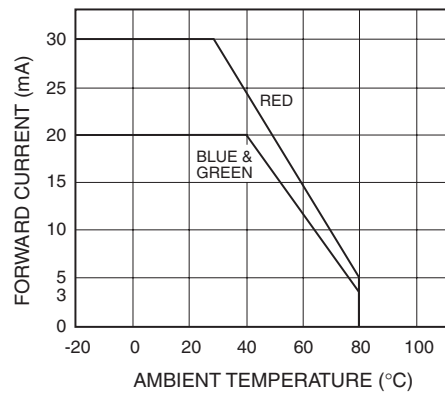
**Fig. 1B Forward Current vs. Forward Voltage**



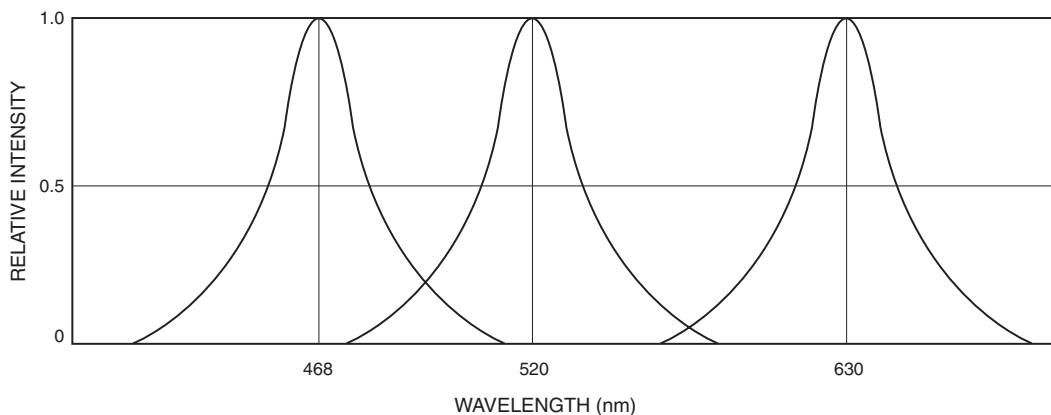
**Fig. 2 Relative Intensity vs. Forward Current**



**Fig. 3 Forward Current vs. Ambient Temperature**

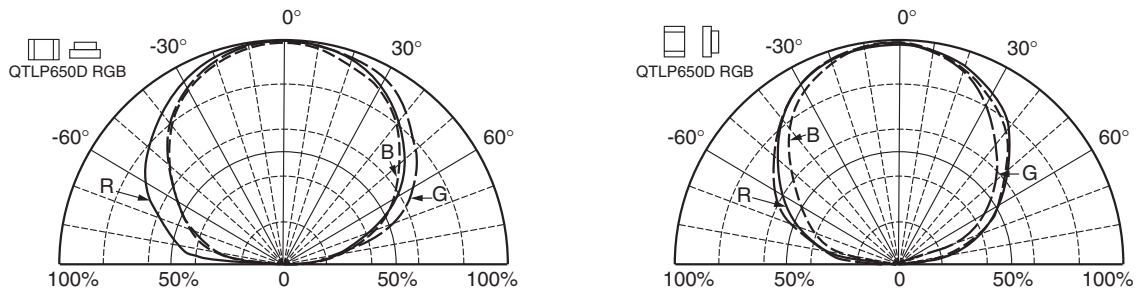


**Fig. 4 Relative Intensity vs. Peak Wavelength**



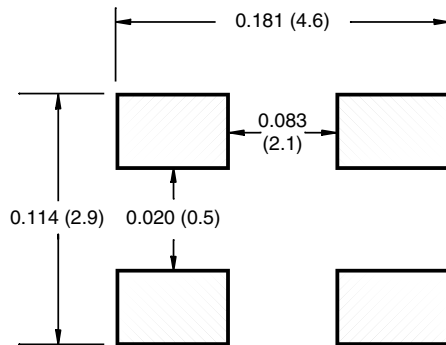
**TYPICAL PERFORMANCE CURVES**

**Fig.5 Radiation Diagrams**

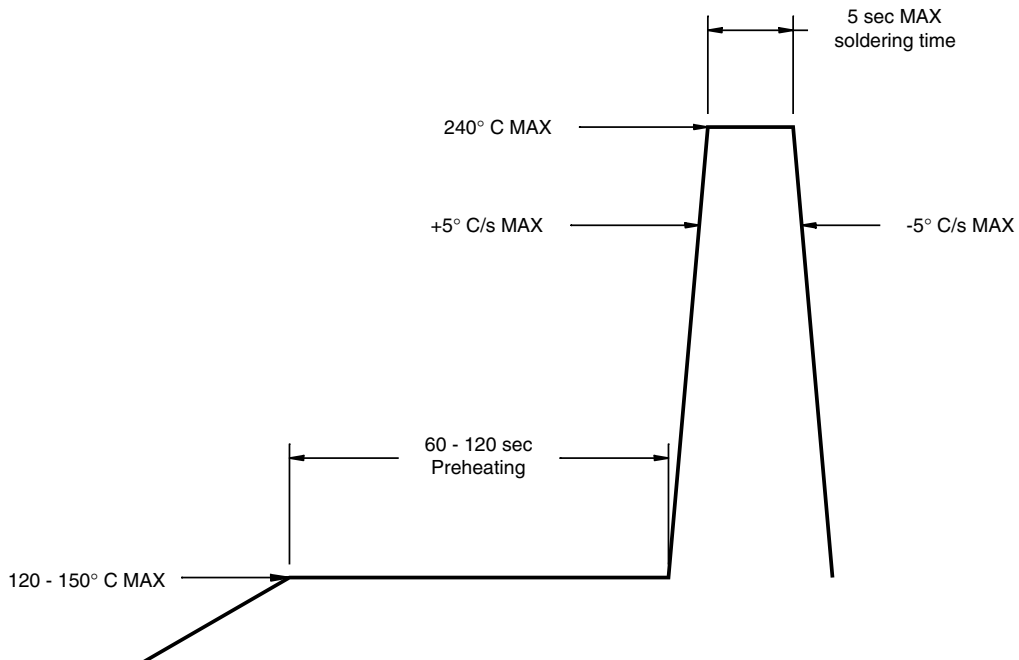


**QTLP650D-RGB Red/Green/Blue**

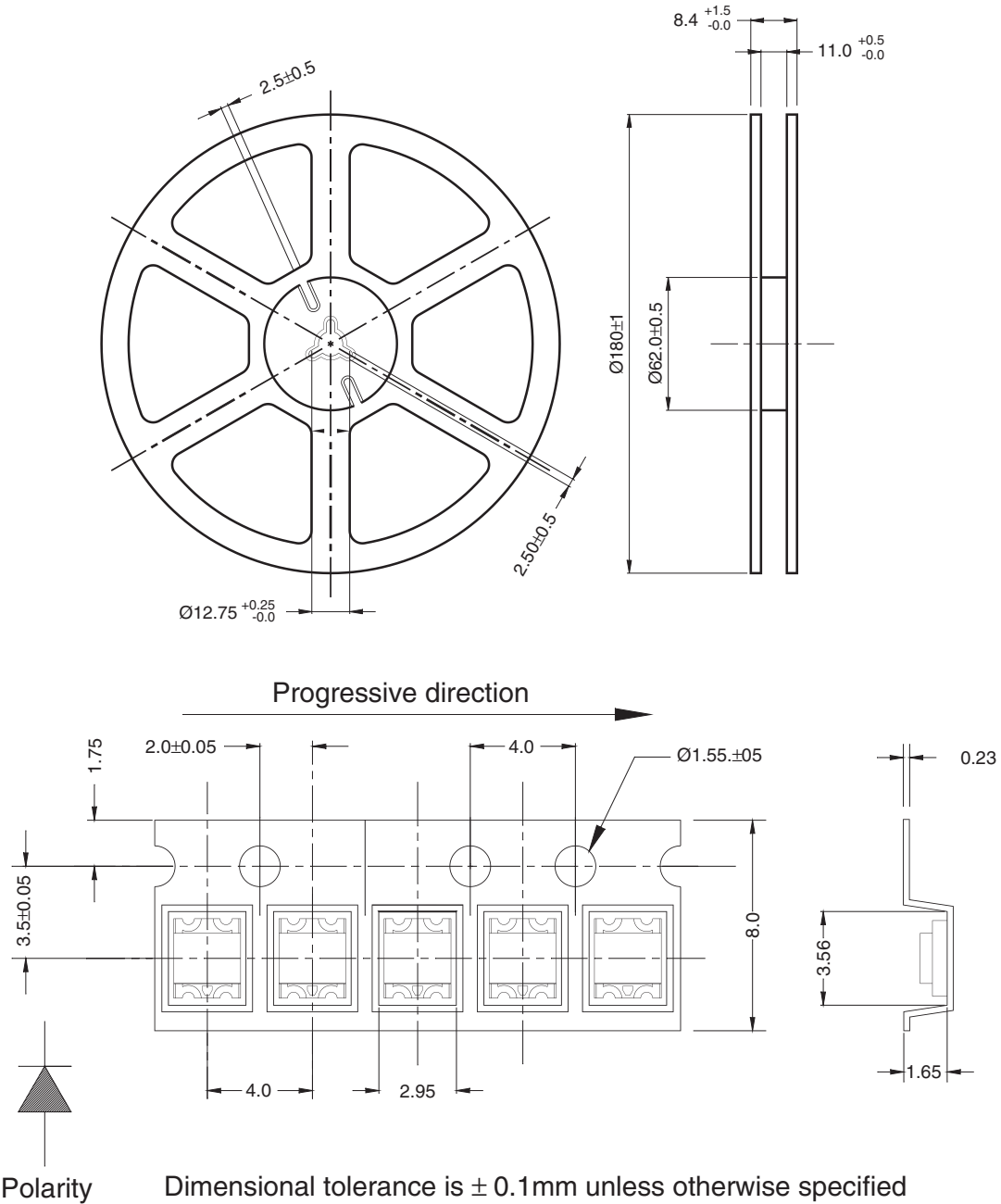
### RECOMMENDED PRINTED CIRCUIT BOARD PATTERN



### RECOMMENDED IR REFLOW SOLDERING PROFILE



**TAPE AND REEL DIMENSIONS**



Dimensional tolerance is  $\pm 0.1$  mm unless otherwise specified

Angle:  $\pm 0.5$

Unit: mm

---

### QTLP650D-RGB Red/Green/Blue

---

#### **DISCLAIMER**

FAIRCHILD SEMICONDUCTOR RESERVES THE RIGHT TO MAKE CHANGES WITHOUT FURTHER NOTICE TO ANY PRODUCTS HEREIN TO IMPROVE RELIABILITY, FUNCTION OR DESIGN. FAIRCHILD DOES NOT ASSUME ANY LIABILITY ARISING OUT OF THE APPLICATION OR USE OF ANY PRODUCT OR CIRCUIT DESCRIBED HEREIN; NEITHER DOES IT CONVEY ANY LICENSE UNDER ITS PATENT RIGHTS, NOR THE RIGHTS OF OTHERS.

#### **LIFE SUPPORT POLICY**

FAIRCHILD'S PRODUCTS ARE NOT AUTHORIZED FOR USE AS CRITICAL COMPONENTS IN LIFE SUPPORT DEVICES OR SYSTEMS WITHOUT THE EXPRESS WRITTEN APPROVAL OF THE PRESIDENT OF FAIRCHILD SEMICONDUCTOR CORPORATION. As used herein:

1. Life support devices or systems are devices or systems which, (a) are intended for surgical implant into the body, or (b) support or sustain life, and (c) whose failure to perform when properly used in accordance with instructions for use provided in the labeling, can be reasonably expected to result in a significant injury of the user.
2. A critical component in any component of a life support device or system whose failure to perform can be reasonably expected to cause the failure of the life support device or system, or to affect its safety or effectiveness.