

PQxxxEF01SZH Series

TO-220 Type, Low Voltage Operation
Low Power-Loss Voltage Regulators

■ Features

1. Low voltage operation
(Minimum operating voltage: 2.35V)
2.5V input → available 1.5 to 1.8V output
2. Low dissipation current
(Dissipation current at no load: MAX. 2mA)
Output OFF-state dissipation current: MAX. 5μA)
3. Low power-loss
Dropout voltage: MAX. 0.5V
4. Built-in overcurrent and overheat protection functions
5. RoHS directive compliant

■ Applications

1. Peripheral equipment of personal computers
2. Power supplies for various electronic equipment such as DVD player or STB
3. LBP

■ Model Line-up

Output voltage	Model No.	Output voltage	Model No.
1.5V	PQ015EF01SZH	2.5V	PQ025EF01SZH
1.8V	PQ018EF01SZH	3.3V	PQ033EF01SZH

■ Absolute Maximum Ratings

(Ta=25°C)

Parameter	Symbol	Rating	Unit
*1 Input voltage	V _{IN}	10	V
*1 ON/OFF control terminal voltage	V _C	10	V
Output current	I _O	1.0	A
	P _{D1}	1.4	W
*2 Power dissipation	P _{D2}	15	
	*3 Junction temperature	T _J	150
Operating temperature	T _{opr}	-40 to +85	°C
Storage temperature	T _{stg}	-40 to +150	°C
Soldering temperature	T _{sol}	260(10s)	°C

*1 All are open except GND and applicable terminals.
*2 P_{D1}: No heat sink, P_{D2}: With infinite heat sink.
*3 Overheat protection may operate at T_J=125°C to 150°C

■ Outline Dimensions

(Unit : mm)

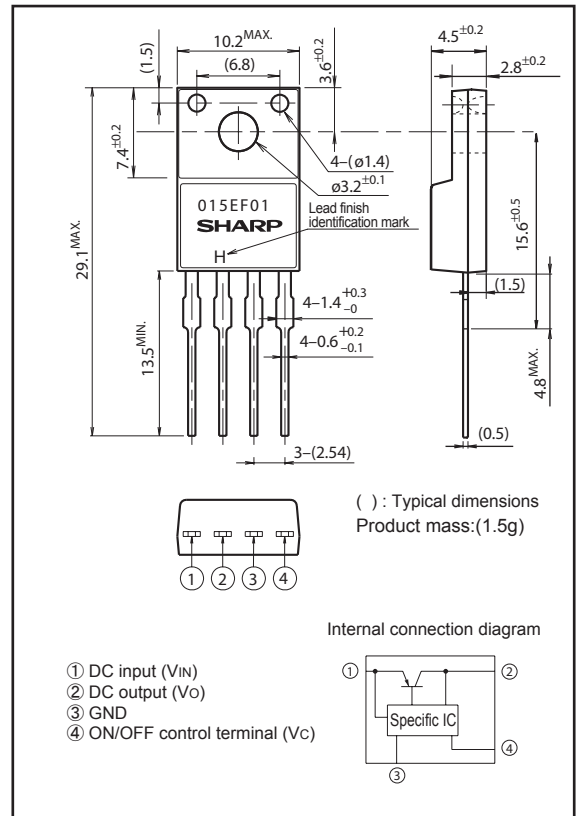

Lead finish: Lead-free solder plating
(Composition: Sn2Cu)

Notice The content of data sheet is subject to change without prior notice.

In the absence of confirmation by device specification sheets, SHARP takes no responsibility for any defects that may occur in equipment using any SHARP devices shown in catalogs, data books, etc. Contact SHARP in order to obtain the latest device specification sheets before using any SHARP device.

Electrical Characteristics

(Unless otherwise specified, condition shall be $V_{IN}=V_O(TYP.)+1V, I_o=0.5A, V_C=2.7V, T_a=25^\circ C$)

Parameter	Symbol	Conditions	MIN.	TYP.	MAX.	Unit
Input voltage	V_{IN}	-	Refer to the table below			V
Output voltage	V_O	-	Refer to the table below			V
Load regulation	RegL	$I_o=5mA$ to 1A	-	0.2	2	%
Line regulation	Regl	$V_{IN}=V_O(TYP.)+1V$ to $V_O(TYP.)+6V, I_o=5mA$	-	0.1	1	%
Temperature coefficient of output voltage	$T_C V_O$	$T_j=0$ to $+125^\circ C, I_o=5mA$	-	± 0.01	-	%/ $^\circ C$
Ripple rejection	RR	-	45	60	-	dB
*5 Dropout voltage	V_{I-O}	$I_o=0.5A$ (at $V_O=0.95V$)	-	-	0.5	V
*4 ON-state voltage for control	$V_{C(ON)}$	-	2	-	-	V
ON-state current for control	$I_{C(ON)}$	-	-	-	200	μA
OFF-state voltage for control	$V_{C(OFF)}$	$I_o=0A$	-	-	0.8	V
OFF-state current for control	$I_{C(OFF)}$	$I_o=0A, V_C=0.4V$	-	-	2	μA
Quiescent current	I_q	$I_o=0A$	-	1	2	mA
Output OFF-state dissipation current	I_{qs}	$I_o=0A, V_C=0.4V$	-	-	5	μA

*4 In case of opening control terminal ④, output voltage turns off.

*5 In case of PQ033EF01SZH, apply to PQ033EF01SZH specification sheet.

Table.1 Input Voltage Range

Model No.	Symbol	Conditions	MIN.	TYP.	MAX.	Unit
PQ015EF01SZH	V_{IN}	$I_o=0.5A, V_C=2.7V, T_a=25^\circ C$	2.35	-	10	V
PQ018EF01SZH			2.35	-	10	
PQ025EF01SZH			3.0	-	10	
PQ033EF01SZH			3.8	-	10	

Table.2 Output Voltage

Model No.	Symbol	Conditions	MIN.	TYP.	MAX.	Unit
PQ015EF01SZH	V_O	$V_{IN}=V_O(TYP.)+1V, I_o=0.5A, V_C=2.7V, T_a=25^\circ C$	1.45	1.5	1.55	V
PQ018EF01SZH			1.75	1.8	1.85	
PQ025EF01SZH			2.438	2.5	2.562	
PQ033EF01SZH			3.218	3.3	3.382	

Fig.1 Test Circuit

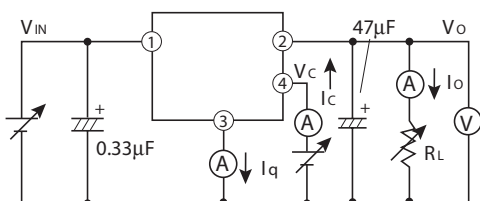
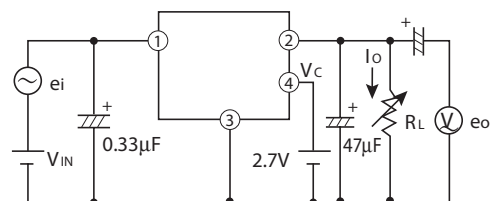
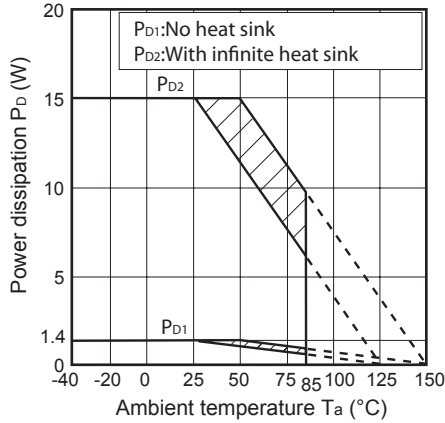

Fig.2 Test Circuit of Ripple Rejection



$f=120Hz$ (sine wave)
 $e_i(rms)=0.5V$
 $V_{IN}=V_O(TYP.)+2V$
 $I_o=0.3A$
 $RR=20 \log(e_i(rms)/e_o(rms))$

Fig.3 Power Dissipation vs. Ambient Temperature



Note) Oblique line portion: Overheat protection may operate in this area.

Fig.4 Overcurrent Protection Characteristics (Typical Value, PQ015EF01SZH)

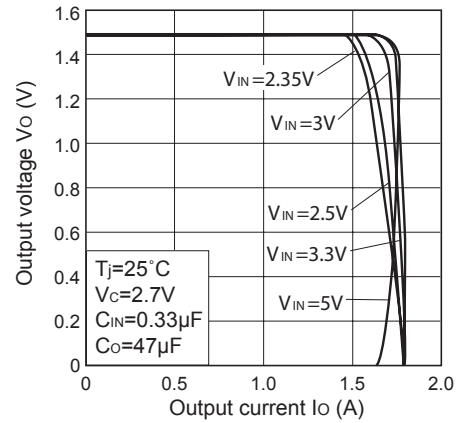

Fig.5 Overcurrent Protection Characteristics (Typical Value, PQ018EF01SZH)

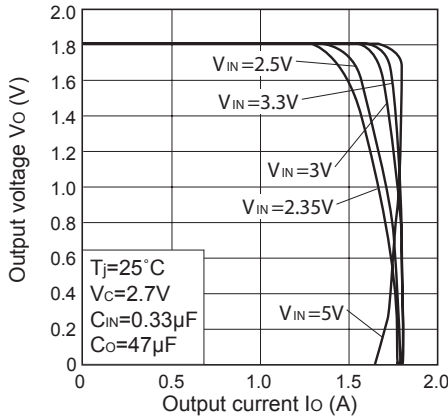

Fig.6 Overcurrent Protection Characteristics (Typical Value, PQ025EF01SZH)

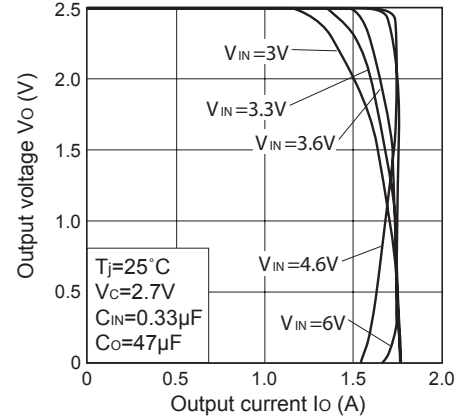

Fig.7 Overcurrent Protection Characteristics (Typical Value, PQ033EF01SZH)

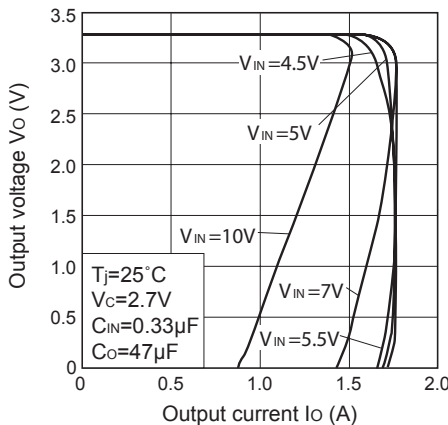

Fig.8 Output Voltage Fluctuation vs. Junction Temperature (PQ015EF01SZH)

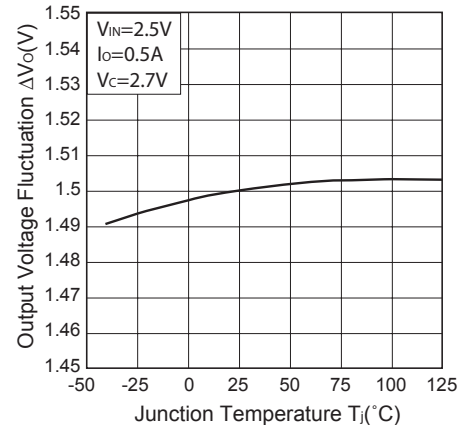

Fig.9 Output Voltage Fluctuation vs. Junction Temperature (PQ018EF01SZH)

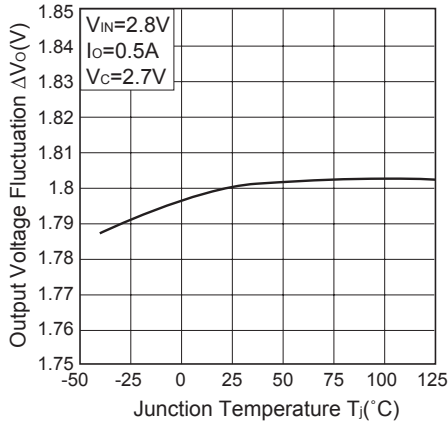

Fig.10 Output Voltage Fluctuation vs. Junction Temperature (PQ025EF01SZH)

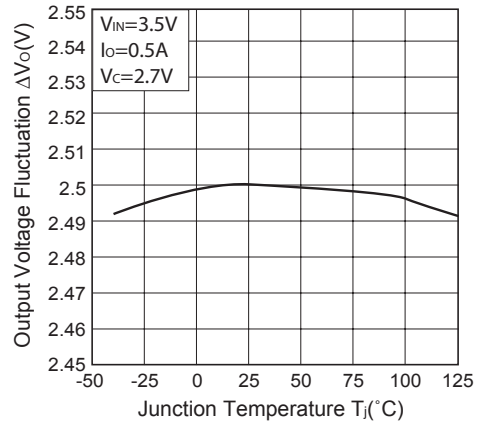

Fig.11 Output Voltage Fluctuation vs. Junction Temperature (PQ033EF01SZH)

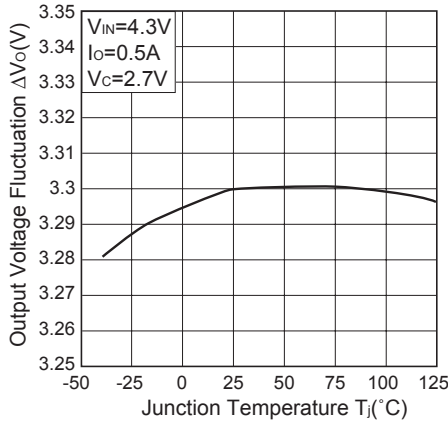

Fig.12 Output Voltage vs. Input Voltage (PQ015EF01SZH)

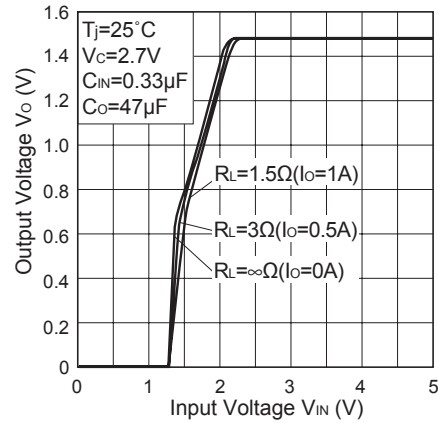

Fig.13 Output Voltage vs. Input Voltage (PQ018EF01SZH)

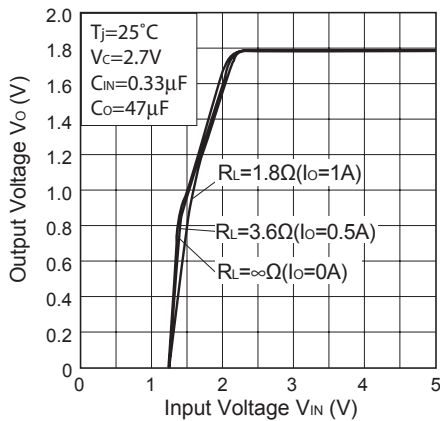

Fig.14 Output Voltage vs. Input Voltage (PQ025EF01SZH)

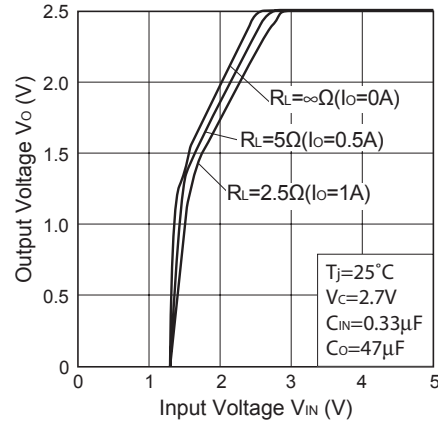

Fig.15 Output Voltage vs. Input Voltage (PQ033EF01SZH)

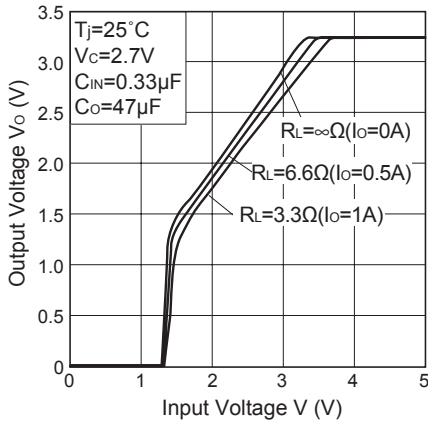

Fig.16 Circuit Operating Current vs. Input Voltage (PQ015EF01SZH)

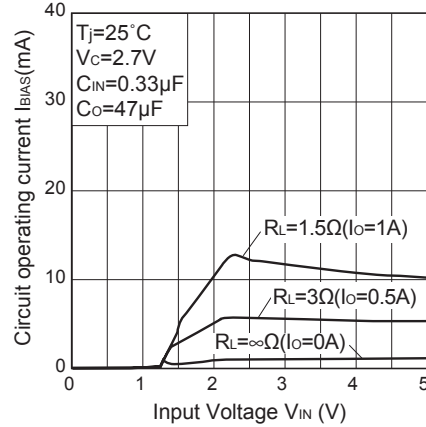

Fig.17 Circuit Operating Current vs. Input Voltage (PQ018EF01SZH)

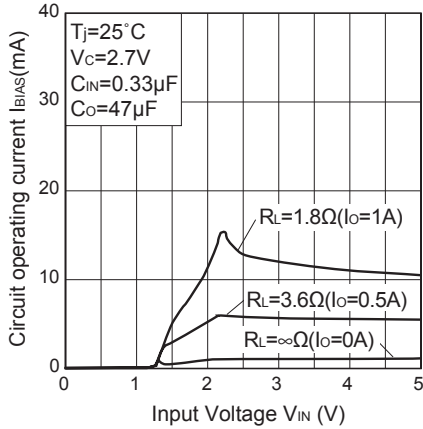

Fig.18 Circuit Operating Current vs. Input Voltage (PQ025EF01SZH)

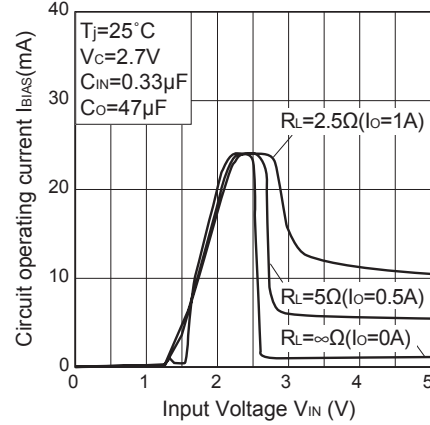

Fig.19 Circuit Operating Current vs. Input Voltage (PQ033EF01SZH)

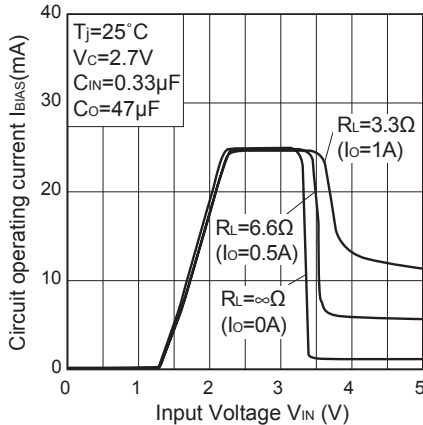

Fig.20 Dropout Voltage vs. Junction Temperature (PQ033EF01SZH)

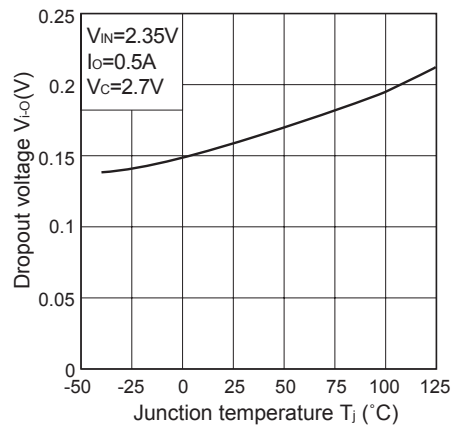

Fig.21 Quiescent Current vs. Junction Temperature

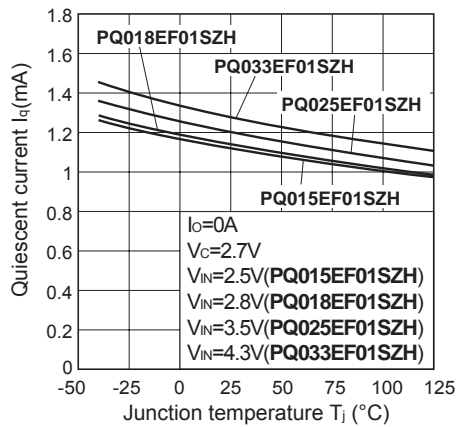

Fig.22 Ripple Rejection vs. Input Ripple Frequency

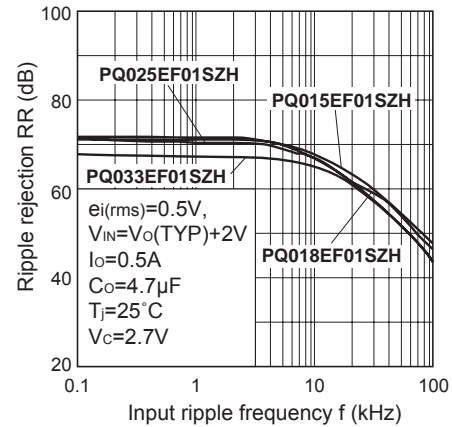
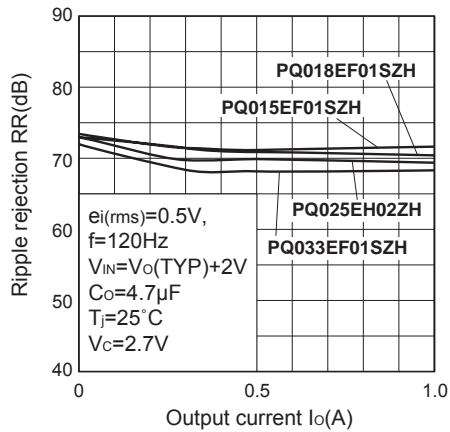

Fig.23 Ripple Rejection vs. Output Current



Typical Application

