

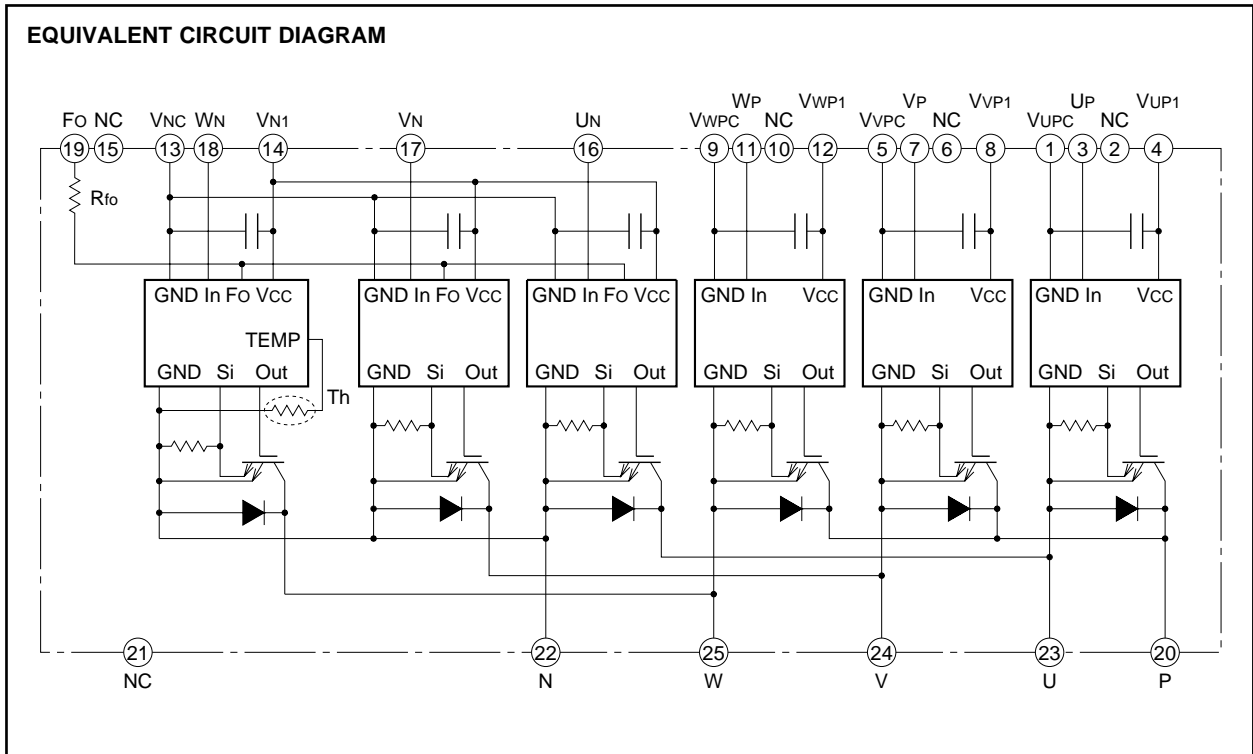

**PM75CTK060**

FLAT-BASE TYPE  
INSULATED PACKAGE



**MAXIMUM RATINGS** ( $T_j = 25^\circ\text{C}$ , unless otherwise noted)

**INVERTER PART**

Symbol	Parameter	Conditions	Ratings	Unit
$V_{CES}$	Collector-emitter voltage	$V_D = 15\text{V}$ , $I_{CIN} = 10\text{mA}$	600	V
$\pm I_C$	Collector current	$T_C = 25^\circ\text{C}$	75	A
$\pm I_{CP}$	Collector current (peak)	$T_C = 25^\circ\text{C}$	150	A
$P_C$	Collector dissipation	$T_C = 25^\circ\text{C}$	134	W
$T_j$	Junction temperature		-20 ~ +150	$^\circ\text{C}$

**CONTROL PART**

Symbol	Parameter	Conditions	Ratings	Unit
$V_D$	Supply voltage	Applied between : $V_{UP1}-V_{UPC}$ , $V_{VP1}-V_{VPC}$ $V_{WP1}-V_{WPC}$ , $V_{N1}-V_{NC}$	20	V
$I_{CIN}$	Input current	Applied between : $U_P-V_{UPC}$ , $V_P-V_{VPC}$ , $W_P-V_{WPC}$ , $U_N \cdot V_N \cdot W_N-V_{NC}$	20	mA
$V_{FO}$	Fault output supply voltage	Applied between : $F_O-V_{NC}$	20	V
$I_{FO}$	Fault output current	Sink current of $F_O$ terminal	20	mA

**PM75CTK060**

FLAT-BASE TYPE  
INSULATED PACKAGE

**TOTAL SYSTEM**

Symbol	Parameter	Conditions	Ratings	Unit
V <sub>CC(Prot)</sub>	Supply voltage protected by OC & SC	V <sub>D</sub> = 13.5 ~ 16.5V, Inverter part, T <sub>j</sub> = 125°C start	400	V
V <sub>CC</sub>	Supply voltage	Applied between : P-N, operating time	450	V
V <sub>CC(surge)</sub>	Supply voltage (surge)	Applied between : P-N, surge and non-operating time	500	V
T <sub>C</sub>	Module case operating temperature	(Note 1)	-20 ~ +100	°C
T <sub>stg</sub>	Storage temperature		-40 ~ +125	°C
V <sub>iso</sub>	Isolation voltage	60Hz, sinusoidal, AC · 1 min	2500	V <sub>rms</sub>

Note 1 : T<sub>C</sub> measuring point is as shown below.

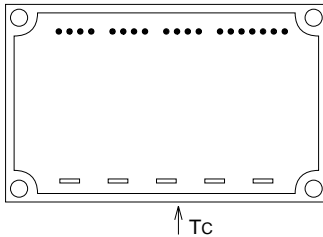

**ELECTRICAL CHARACTERISTICS** (T<sub>j</sub> = 25°C, unless otherwise noted)

**INVERTER PART**

Symbol	Parameter	Test conditions	Limits			Unit
			Min.	Typ.	Max.	
V <sub>CE(sat)</sub>	Collector-emitter saturation voltage	V <sub>D</sub> = 15V, I <sub>CIN</sub> = 10mA I <sub>C</sub> = 75A, T <sub>j</sub> = 25°C I <sub>C</sub> = 75A, T <sub>j</sub> = 125°C	—	1.8 1.85	2.7 2.78	V
V <sub>EC</sub>	FWDi forward voltage	-I <sub>C</sub> = 75A, V <sub>D</sub> = 15V, I <sub>CIN</sub> = 0mA	—	2.2	3.3	V
t <sub>on</sub>	Switching time	V <sub>D</sub> = 15V, I <sub>CIN</sub> = 0mA↔10mA V <sub>CC</sub> = 300V, I <sub>C</sub> = 75A T <sub>j</sub> = 125°C (Per 1 arm) Inductive Load	0.6	1.2	2.4	μs
t <sub>tr</sub>			—	0.15	0.3	μs
t <sub>c(on)</sub>			—	0.5	1.1	μs
t <sub>off</sub>			—	2.8	3.6	μs
t <sub>c(off)</sub>			—	0.6	1.2	μs
I <sub>CES</sub>	Collector-emitter cutoff current	V <sub>CE</sub> = V <sub>CEs</sub> , I <sub>CIN</sub> = 0mA T <sub>j</sub> = 25°C T <sub>j</sub> = 125°C	—	—	1 10	mA

**CONTROL PART**

Symbol	Parameter	Test conditions	Limits			Unit	
			Min.	Typ.	Max.		
I <sub>D</sub>	Circuit current	V <sub>D</sub> = 15V, I <sub>CIN</sub> = 0mA V <sub>N1</sub> -V <sub>Nc</sub> V <sub>XP1</sub> -V <sub>XPc</sub>	—	40 13	55 18	mA	
I <sub>th(ON)</sub>	Input on threshold current	Applied between : UP-VUPC, VP-VVPC, WP-VWPC	1	3	5	mA	
I <sub>th(OFF)</sub>	Input off threshold current	U <sub>N</sub> · V <sub>N</sub> · W <sub>N</sub> -V <sub>Nc</sub>	1	3	5	mA	
OC	Over current trip level	-20°C ≤ T <sub>j</sub> ≤ 125°C, V <sub>D</sub> = 15V	115	161	—	A	
SC	Short circuit trip level	-20°C ≤ T <sub>j</sub> ≤ 125°C, V <sub>D</sub> = 15V	—	241	—	A	
t <sub>off(OC)</sub>	Over current delay time	V <sub>D</sub> = 15V	—	10	—	μs	
OT	Over temperature protection	Base-plate	Trip level	100	110	120	°C
OT <sub>r</sub>		Temperature detection, V <sub>D</sub> = 15V	Reset level	—	90	—	°C
UV	Supply circuit under voltage protection	-20°C ≤ T <sub>j</sub> ≤ 125°C	Trip level	11.5	12.0	12.5	V
UV <sub>r</sub>			Reset level	—	12.5	—	V
I <sub>FO(H)</sub>	Fault output current (Note 2)	V <sub>D</sub> = 15V, V <sub>FO</sub> = 15V	—	—	0.01	mA	
I <sub>FO(L)</sub>			—	10	15	mA	
t <sub>FO</sub>	Minimum fault output pulse width (Note 2)	V <sub>D</sub> = 15V	1.0	1.8	—	ms	

Note 2 : Fault output is given only when the internal OC, SC, OT & UV protection.  
 Fault output of OC, SC protection operate by lower arm.  
 Fault output of OC, SC protection given pulse.  
 Fault output of OT, UV protection given pulse while over level. (OT is only N side)

**PM75CTK060**

FLAT-BASE TYPE  
INSULATED PACKAGE

**THERMAL RESISTANCES**

Symbol	Parameter	Test conditions	Limits			Unit
			Min.	Typ.	Max.	
R <sub>th(j-c)Q</sub>	Junction to case thermal resistances	Inverter IGBT part, per 1/6 module	—	—	0.93	°C / W
R <sub>th(j-c)F</sub>		Inverter FWDi part, per 1/6 module	—	—	0.91	°C / W
R <sub>th(c-f)</sub>	Contact thermal resistance	Case to fin, thermal grease applied, per 1 module	—	—	0.036	°C / W

**MECHANICAL RATINGS AND CHARACTERISTICS**

Symbol	Parameter	Test conditions	Limits			Unit
			Min.	Typ.	Max.	
—	Mounting torque	Mounting screw : M4	0.98	1.18	1.47	N·m
—	Weight		10	12	15	kg·cm
—	Weight		—	150	—	g

**RECOMMENDED CONDITIONS FOR USE**

Symbol	Parameter	Test conditions	Ratings	Unit
V <sub>CC</sub>	Supply voltage	Applied between : P-N	≤ 400	V
V <sub>D</sub>		Applied between : V <sub>UP1</sub> -V <sub>UPC</sub> , V <sub>VP1</sub> -V <sub>VPC</sub> V <sub>WP1</sub> -V <sub>WPC</sub> , V <sub>UN1</sub> -V <sub>UNC</sub> (Note 3)	15 ± 1.5	V
I <sub>CIN(ON)</sub>	Input on current	Applied between : UP, VP, WP, UN, VN, WN	≥ 5	mA
I <sub>CIN(OFF)</sub>	Input off current		≤ 1	mA
f <sub>PWM</sub>	PWM input frequency	Using application circuit Opto-coupler's input signal	≤ 8	kHz
t <sub>dead</sub>	Arm shoot-through blocking time	Using application circuit Opto-coupler's input signal	≥ 3	μs

Note 3 : Permissible ripple value : dv/dt ≤ ±5V/μs, V<sub>ripple</sub> ≤ 2V<sub>P-P</sub>

# PM75CTK060

FLAT-BASE TYPE  
INSULATED PACKAGE

## PERFORMANCE CURVES

**OUTPUT CHARACTERISTICS (TYPICAL)**

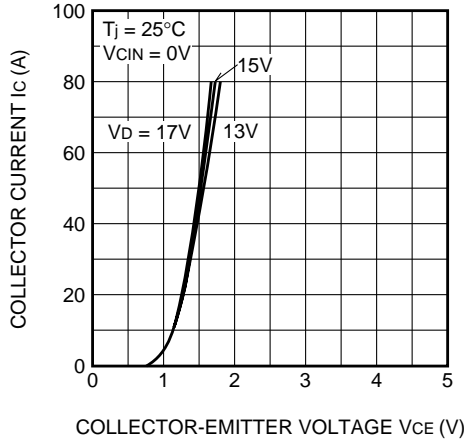

**COLLECTOR-EMITTER SATURATION VOLTAGE CHARACTERISTICS (TYPICAL)**

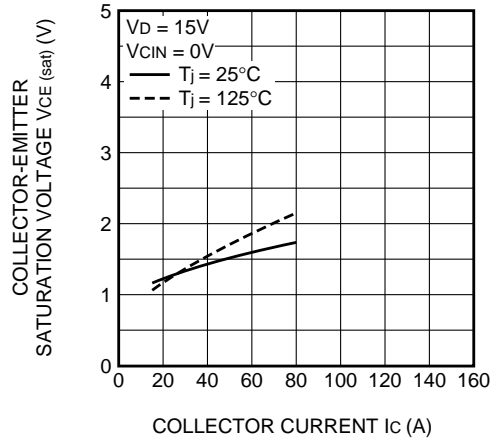

**COLLECTOR-EMITTER SATURATION VOLTAGE VS. SUPPLY VOLTAGE (TYPICAL)**

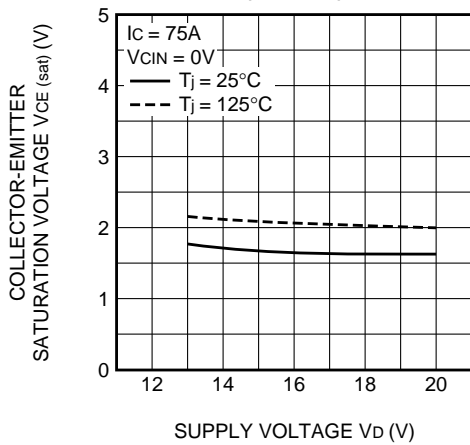

**SWITCHING TIME VS. COLLECTOR CURRENT (TYPICAL)**

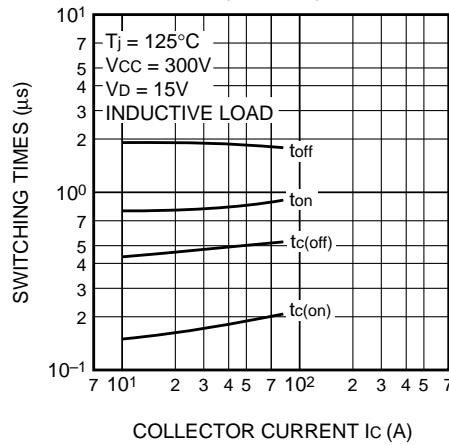

**FREE-WHEEL DIODE FORWARD CHARACTERISTICS (TYPICAL)**

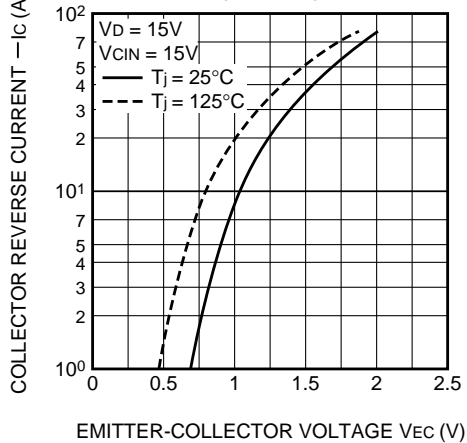

**REVERSE RECOVERY CHARACTERISTICS OF FREE-WHEEL DIODE (TYPICAL)**

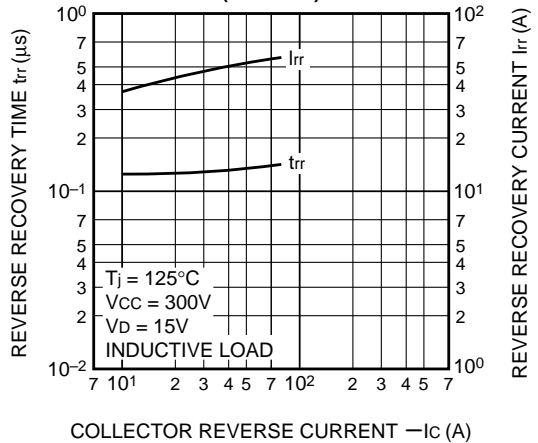

**PM75CTK060**

FLAT-BASE TYPE  
INSULATED PACKAGE

