

# MaxSiC™ 1200 V N-Channel SiC MOSFET

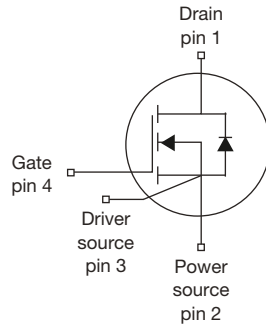

## FEATURES

- Fast switching speed
- Short circuit withstand time 3  $\mu$ s
- Material categorization: for definitions of compliance please see [www.vishay.com/doc?99912](http://www.vishay.com/doc?99912)



**RoHS**  
COMPLIANT  
HALOGEN  
**FREE**

## APPLICATIONS

- Charger
- Boost inverter
- DC/DC converter

Marking Code: 120A045FL

PRODUCT SUMMARY	
$V_{DS}$ (V) at $T_J$ max.	1200
$R_{DS(on)}$ typ. ( $m\Omega$ ) at 25 °C	$V_{GS} = 20$ V   45
$Q_g$ typ. (nC)	75.6
$I_D$ (A)	49
$C_{oss}$ typ. (pF)	90
$P_D$ (W)	227
Configuration	Single

ORDERING INFORMATION	
Package	TO-247 4L
Lead (Pb)-free and halogen-free	MXP120A045FL-Y-GE3

ABSOLUTE MAXIMUM RATINGS ( $T_C = 25$ °C, unless otherwise noted)				
PARAMETER		SYMBOL	LIMIT	UNIT
Drain-source voltage <sup>a</sup>		$V_{DS}$	1200	V
Gate-source voltage		$V_{GS}$	-10 / +22	
Continuous drain current	$T_C = 25$ °C	$I_D$	49	A
Continuous drain current	$T_C = 100$ °C	$I_D$	31	
Pulsed drain current <sup>b</sup>		$I_{DM}$	98	
Short-circuit withstand time		$T_{SC}$	3	$\mu$ s
Maximum power dissipation	$T_C = 25$ °C	$P_D$	227	W
	$T_C = 100$ °C	$P_D$	91	W
Operating junction and storage temperature range		$T_J, T_{stg}$	-55 to +150	°C
Soldering recommendations (peak temperature)	For 10 s		260	°C

### Notes

- a.  $T_J = 25$  °C to 150 °C  
 b. Repetitive rating; pulse width limited by maximum junction temperature



THERMAL RESISTANCE RATINGS				
PARAMETER	SYMBOL	TYP.	MAX.	UNIT
Maximum junction-to-ambient	$R_{thJA}$	-	40	°C/W
Maximum junction-to-case (drain)	$R_{thJC}$	-	0.55	

SPECIFICATIONS ( $T_J = 25\text{ °C}$ , unless otherwise noted)						
PARAMETER	SYMBOL	TEST CONDITIONS		MIN.	TYP.	MAX. UNIT
<b>Static</b>						
Drain-source breakdown voltage	$V_{DS}$	$V_{GS} = 0\text{ V}, I_D = 1\text{ mA}$		1200	-	- V
Gate-source threshold voltage (N)	$V_{GS(th)}$	$V_{DS} = V_{GS}, I_D = 5\text{ mA}$		-	2.38	- V
		$V_{DS} = V_{GS}, I_D = 5\text{ mA}, T_J = 150\text{ °C}$		-	1.65	- V
Gate-source leakage	$I_{GSS}$	$V_{GS} = 22\text{ V}, V_{DS} = 0\text{ V}$		-	-	100 nA
		$V_{GS} = -10\text{ V}, V_{DS} = 0\text{ V}$		-	-	-100 nA
Zero gate voltage drain current	$I_{DSS}$	$V_{DS} = 960\text{ V}, V_{GS} = 0\text{ V}$		-	-	10 $\mu$ A
Drain-source on-state resistance	$R_{DS(on)}$	$V_{GS} = 20\text{ V}, I_D = 20\text{ A}$		-	45	56 m $\Omega$
		$V_{GS} = 20\text{ V}, I_D = 20\text{ A}, T_J = 150\text{ °C}$		-	75	94 m $\Omega$
		$V_{GS} = 18\text{ V}, I_D = 20\text{ A}$		-	52	65 m $\Omega$
		$V_{GS} = 18\text{ V}, I_D = 20\text{ A}, T_J = 150\text{ °C}$		-	81	101 m $\Omega$
<b>Dynamic</b>						
Input capacitance	$C_{iss}$	$V_{GS} = 0\text{ V}, V_{DS} = 800\text{ V}, f = 1\text{ MHz}$		-	1958	- pF
Output capacitance	$C_{oss}$			-	90	- pF
Reverse transfer capacitance	$C_{rss}$			-	4	- pF
Total gate charge	$Q_g$	$V_{GS} = 18\text{ V}$	$I_D = 20\text{ A}, V_{DS} = 800\text{ V}$	-	75.6	- nC
Gate-source charge	$Q_{gs}$			-	19.5	- nC
Gate-drain charge	$Q_{gd}$			-	26.2	- nC
Gate Resistance	$R_g$	$V_{DS} = 0\text{ V}, f = 1\text{ MHz}$		-	4.9	- $\Omega$
<b>Switching Characteristics</b>						
Turn-on delay time	$t_{d(on)}$	$V_{GS} = -5\text{ V} \sim 18\text{ V}, I_D = 20\text{ A}, V_{DS} = 800\text{ V}, R_{g(ext)} = 4.4\text{ }\Omega$		-	15	- ns
Rise time	$t_r$			-	21	- ns
Turn-off delay time	$t_{d(off)}$			-	23	- ns
Fall time	$t_f$			-	11	- ns
Turn-on switching energy	$E_{on}$			-	295	- $\mu$ J
Turn-off switching energy	$E_{off}$	-	34	- $\mu$ J		
<b>Reverse Diode Characteristics</b>						
Reverse recovery time	$t_{rr}$	$V_{GS} = -5\text{ V}, I_{SD} = 20\text{ A}, V_R = 800\text{ V}, di/dt = 1000\text{ A}/\mu\text{s}$		-	17	- ns
Reverse recovery charge	$Q_{rr}$			-	65	- nC
Reverse recovery current	$I_{rrm}$			-	6.6	- A

**TYPICAL CHARACTERISTICS** (25 °C, unless otherwise noted)

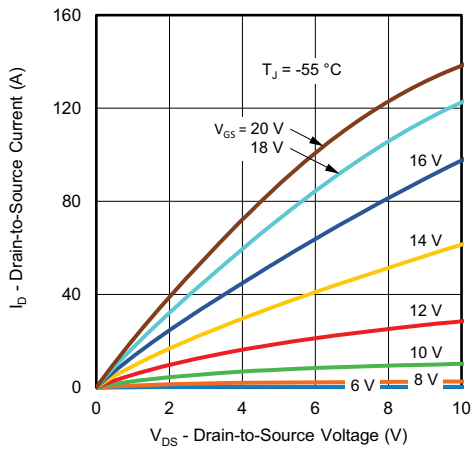

**Fig. 1 - Typical Output Characteristics**

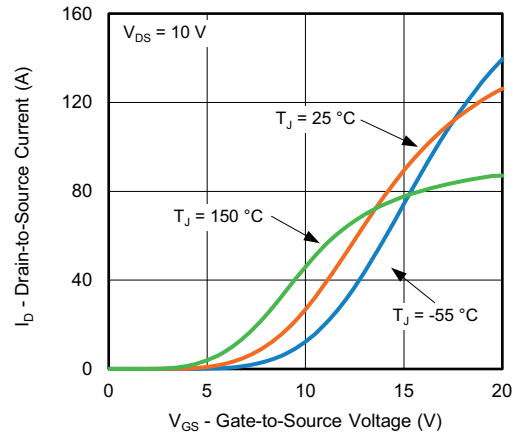

**Fig. 4 - Typical Transfer Characteristics**

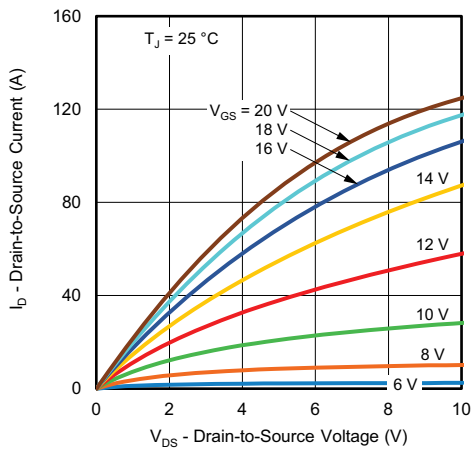

**Fig. 2 - Typical Output Characteristics**

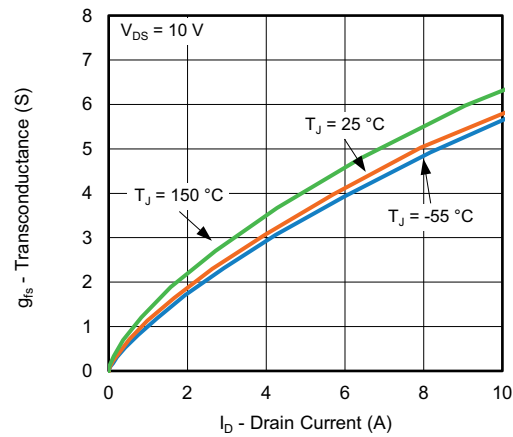

**Fig. 5 - Forward Transconductance vs. Drain Current**

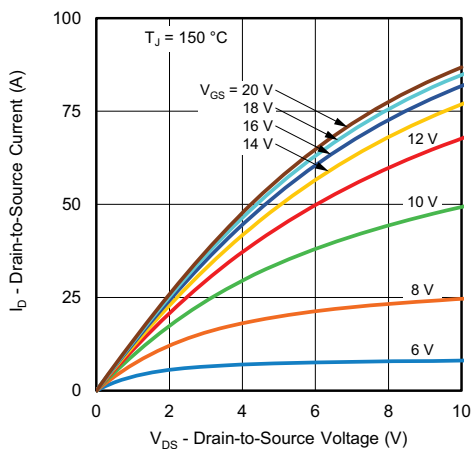

**Fig. 3 - Typical Output Characteristics**

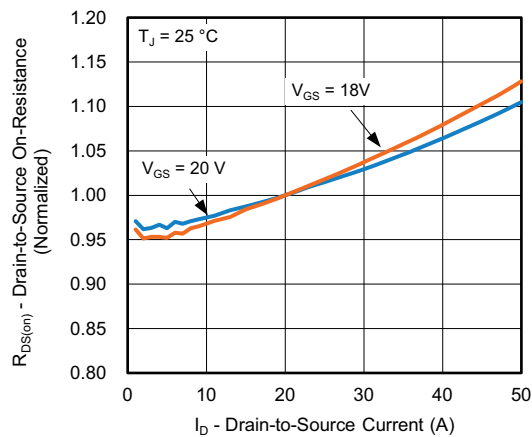

**Fig. 6 - Normalized On-Resistance vs. Drain-to-Source Current**

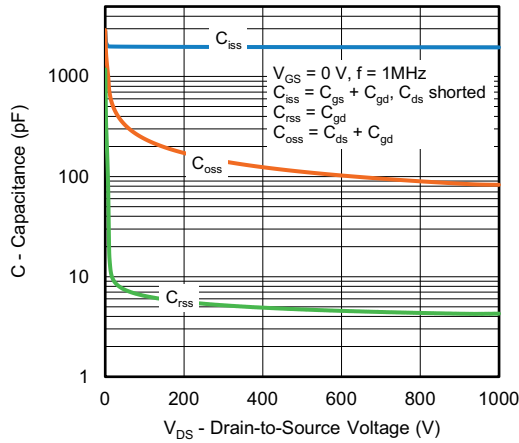

**Fig. 7 - Typical Capacitance vs. Drain-to-Source Voltage**

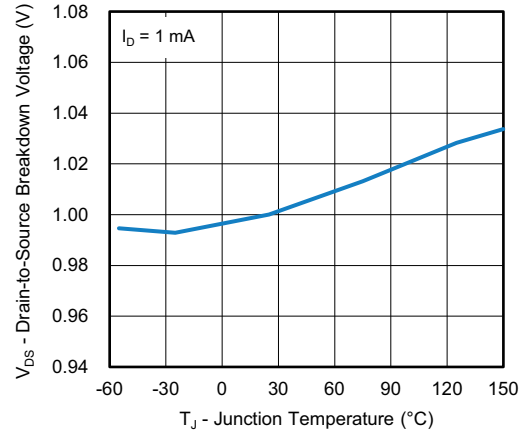

**Fig. 10 - Temperature vs. Drain-to-Source Voltage**

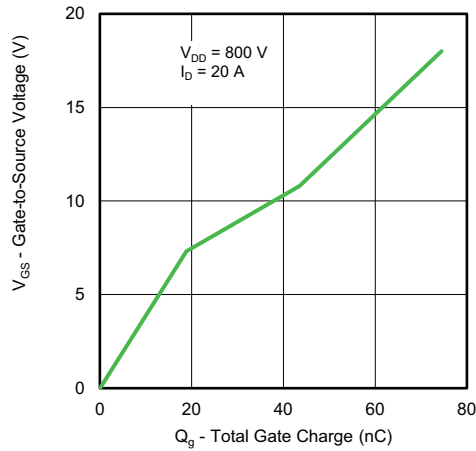

**Fig. 8 - Typical Gate Charge vs. Gate-to-Source Voltage**

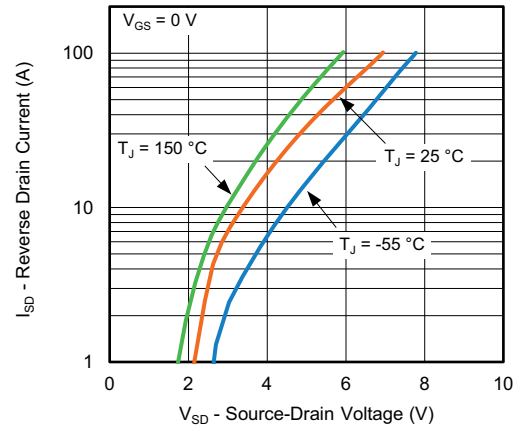

**Fig. 11 - Typical Source-Drain Diode Forward Voltage**

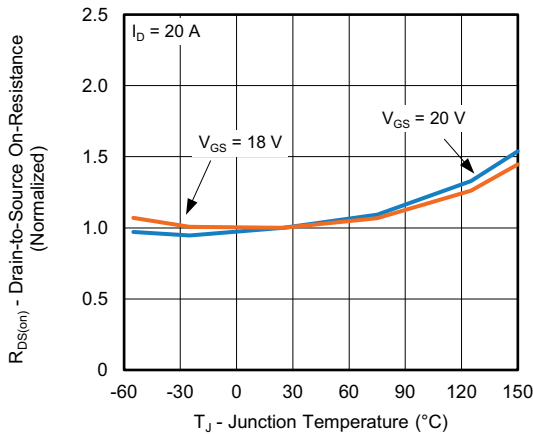

**Fig. 9 - Normalized On-Resistance vs. Temperature**

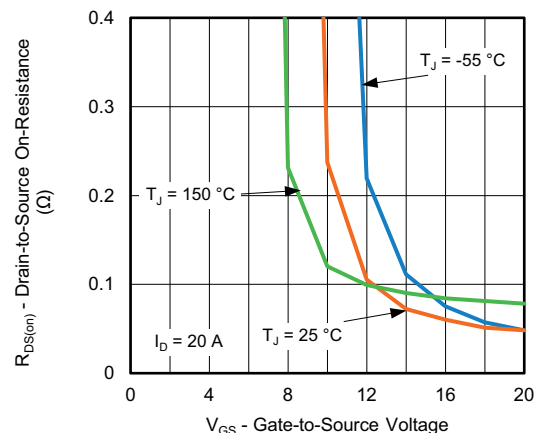

**Fig. 12 - On-Resistance vs. Gate-to-Source Voltage**

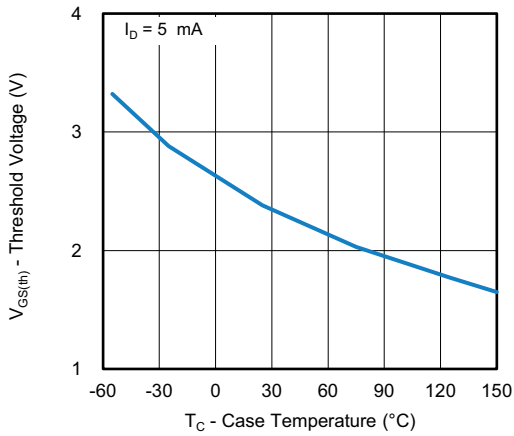

**Fig. 13 - Threshold Voltage vs. Case Temperature**

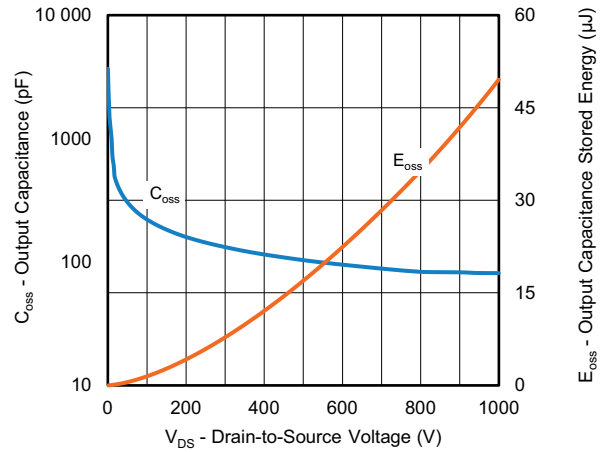

**Fig. 15 - Output Capacitance and its Stored Energy vs. Drain-to-Source Voltage**

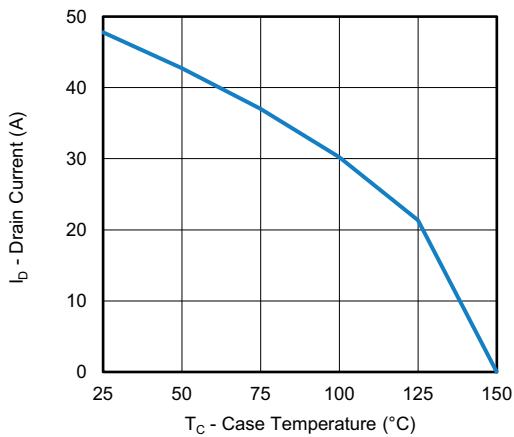

**Fig. 14 - Drain Current vs. Case Temperature**

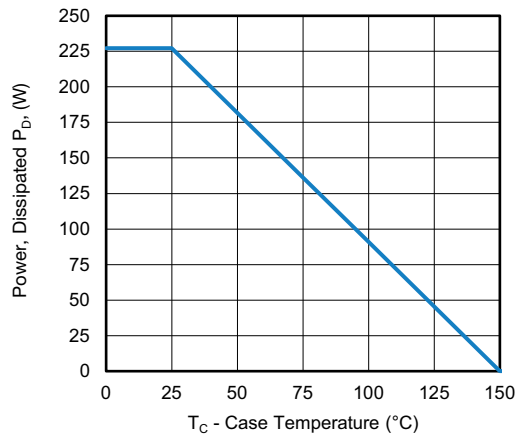

**Fig. 16 - Power, Dissipated  $P_D$  vs. Case Temperature**

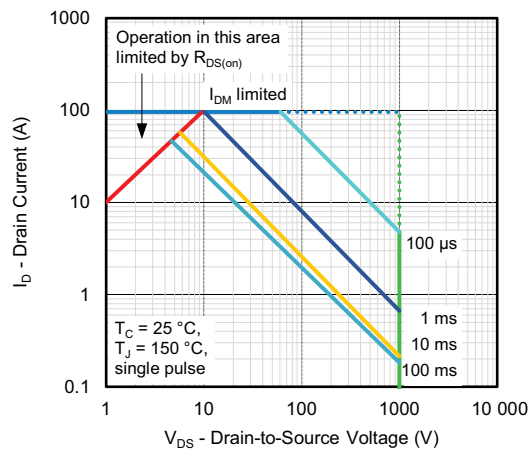

**Fig. 17 - Safe Operating Area**

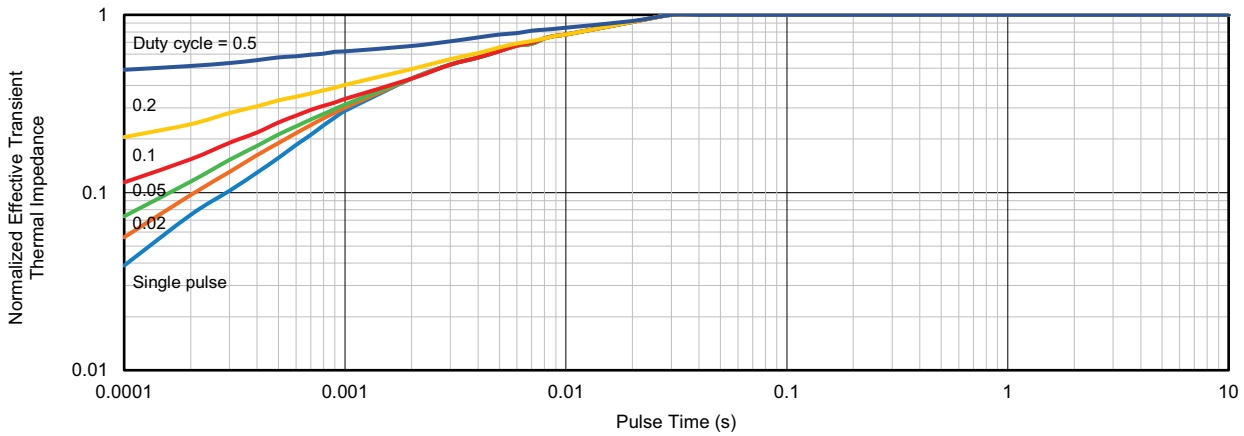
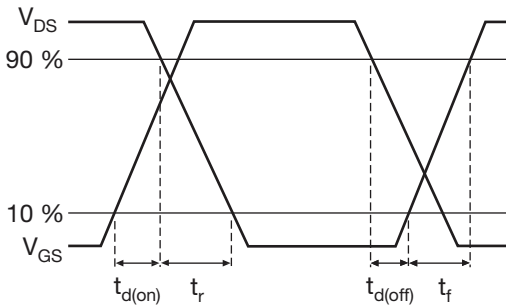
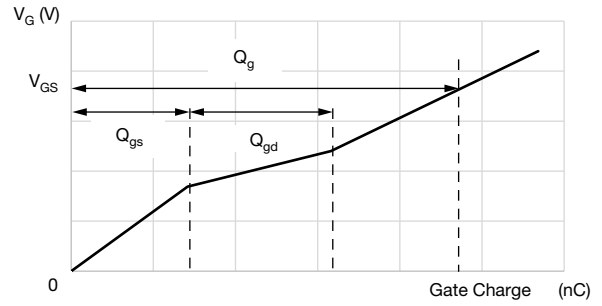

Fig. 18 - Normalized Effective Transient Thermal Impedance



**Fig. 19 - Waveforms of Switching Time**



**Fig. 22 - Waveforms for Gate Charge**

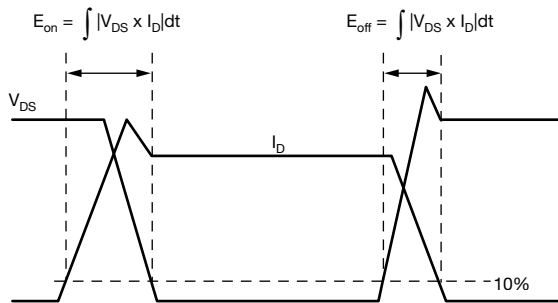

**Fig. 20 - Waveforms for Switching Energy**

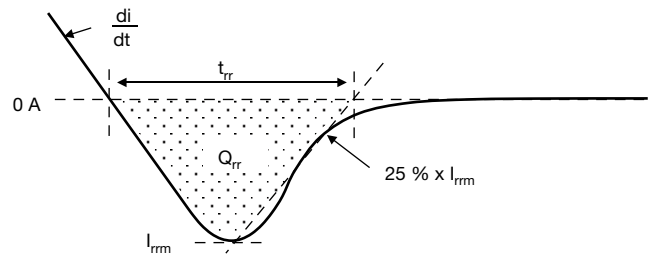

**Fig. 23 - Waveforms for Reverse Recovery**

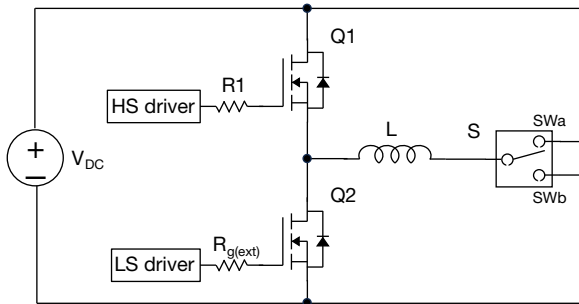

**Fig. 21 - Switching and Reverse Diode Characteristics Measurement Circuit**

Vishay Siliconix maintains worldwide manufacturing capability. Products may be manufactured at one of several qualified locations. Reliability data for Silicon Technology and Package Reliability represent a composite of all qualified locations. For related documents such as package / tape drawings, part marking, and reliability data, see [www.vishay.com/ppg?92817](http://www.vishay.com/ppg?92817).



## Disclaimer

ALL PRODUCT, PRODUCT SPECIFICATIONS AND DATA ARE SUBJECT TO CHANGE WITHOUT NOTICE TO IMPROVE RELIABILITY, FUNCTION OR DESIGN OR OTHERWISE.

Vishay Intertechnology, Inc., its affiliates, agents, and employees, and all persons acting on its or their behalf (collectively, "Vishay"), disclaim any and all liability for any errors, inaccuracies or incompleteness contained in any datasheet or in any other disclosure relating to any product.

Vishay makes no warranty, representation or guarantee regarding the suitability of the products for any particular purpose or the continuing production of any product. To the maximum extent permitted by applicable law, Vishay disclaims (i) any and all liability arising out of the application or use of any product, (ii) any and all liability, including without limitation special, consequential or incidental damages, and (iii) any and all implied warranties, including warranties of fitness for particular purpose, non-infringement and merchantability.

Statements regarding the suitability of products for certain types of applications are based on Vishay's knowledge of typical requirements that are often placed on Vishay products in generic applications. Such statements are not binding statements about the suitability of products for a particular application. It is the customer's responsibility to validate that a particular product with the properties described in the product specification is suitable for use in a particular application. Parameters provided in datasheets and / or specifications may vary in different applications and performance may vary over time. All operating parameters, including typical parameters, must be validated for each customer application by the customer's technical experts. Product specifications do not expand or otherwise modify Vishay's terms and conditions of purchase, including but not limited to the warranty expressed therein.

Hyperlinks included in this datasheet may direct users to third-party websites. These links are provided as a convenience and for informational purposes only. Inclusion of these hyperlinks does not constitute an endorsement or an approval by Vishay of any of the products, services or opinions of the corporation, organization or individual associated with the third-party website. Vishay disclaims any and all liability and bears no responsibility for the accuracy, legality or content of the third-party website or for that of subsequent links.

Except as expressly indicated in writing, Vishay products are not designed for use in medical, life-saving, or life-sustaining applications or for any other application in which the failure of the Vishay product could result in personal injury or death. Customers using or selling Vishay products not expressly indicated for use in such applications do so at their own risk. Please contact authorized Vishay personnel to obtain written terms and conditions regarding products designed for such applications.

No license, express or implied, by estoppel or otherwise, to any intellectual property rights is granted by this document or by any conduct of Vishay. Product names and markings noted herein may be trademarks of their respective owners.