

*Designer's™ Data Sheet*  
**Insulated Gate Bipolar Transistor**  
**N-Channel Enhancement-Mode Silicon Gate**

**MGS05N60D**

This IGBT contains a built-in free wheeling diode and a gate protection zener diodes. Fast switching characteristics result in efficient operation at higher frequencies. This device is ideally suited for high frequency electronic ballasts.

**IGBT**  
**0.5 A @ 25°C**  
**600 V**

- Built-In Free Wheeling Diodes
- Built-In Gate Protection Zener Diode
- Industry Standard Package (TO92 — 1.0 Watt)
- High Speed  $E_{off}$ : Typical 6.5  $\mu$ s @  $I_C = 0.3$  A;  $T_C = 125^\circ$ C and  $dV/dt = 1000$  V/ $\mu$ s
- Robust High Voltage Termination
- Robust Turn-Off SOA

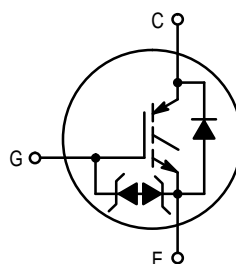
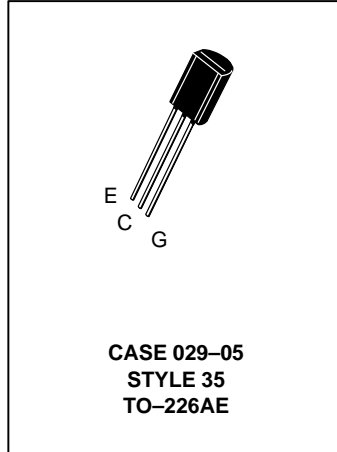

**MAXIMUM RATINGS** ( $T_C = 25^\circ$ C unless otherwise noted)

Parameters	Symbol	Value	Unit
Collector-Emitter Voltage	$V_{CES}$	600	Vdc
Collector-Gate Voltage ( $R_{GE} = 1.0$ M $\Omega$ )	$V_{CGR}$	600	Vdc
Gate-Emitter Voltage — Continuous	$V_{GES}$	$\pm 15$	Vdc
Collector Current — Continuous @ $T_C = 25^\circ$ C — Continuous @ $T_C = 90^\circ$ C — Repetitive Pulsed Current (1)	$I_{C25}$ $I_{C90}$ $I_{CM}$	0.5 0.3 2.0	Adc
Total Power Dissipation	$P_D$	1.0	Watt
Operating and Storage Junction Temperature Range	$T_J, T_{stg}$	-55 to 150	$^\circ$ C

**THERMAL CHARACTERISTICS**

Thermal Resistance — Junction to Case – IGBT — Junction to Ambient	$R_{\theta JC}$ $R_{\theta JA}$	25 125	$^\circ$ C/W
Maximum Lead Temperature for Soldering Purposes, 1/8" from case for 5 seconds	$T_L$	260	$^\circ$ C

**UNCLAMPED DRAIN-TO-SOURCE AVALANCHE CHARACTERISTICS** ( $T_C \leq 150^\circ$ C)

Single Pulse Drain-to-Source Avalanche Energy – Starting @ $T_C = 25^\circ$ C @ $T_C = 125^\circ$ C $V_{CE} = 100$ V, $V_{GE} = 15$ V, Peak $I_L = 2.0$ A, $L = 3.0$ mH, $R_G = 25$ $\Omega$	$E_{AS}$	125 40	mJ
--	----------	-----------	----

(1) Pulse width is limited by maximum junction temperature repetitive rating.

**Designer's Data for "Worst Case" Conditions** — The Designer's Data Sheet permits the design of most circuits entirely from the information presented. SOA Limit curves — representing boundaries on device characteristics — are given to facilitate "worst case" design.

Designer's is a trademark of Motorola, Inc.

# MGS05N60D

## ELECTRICAL CHARACTERISTICS ( $T_C = 25^\circ\text{C}$ unless otherwise noted)

Characteristic	Symbol	Min	Typ	Max	Unit
<b>OFF CHARACTERISTICS</b>					
Collector-to-Emitter Breakdown Voltage ( $V_{GE} = 0\text{ Vdc}$ , $I_C = 250\ \mu\text{Adc}$ ) Temperature Coefficient (Positive)	$V_{(BR)CES}$	600 —	680 0.7	— —	Vdc V/ $^\circ\text{C}$
Zero Gate Voltage Collector Current ( $V_{CE} = 600\text{ Vdc}$ , $V_{GE} = 0\text{ Vdc}$ ) ( $V_{CE} = 600\text{ Vdc}$ , $V_{GE} = 0\text{ Vdc}$ , $T_C = 125^\circ\text{C}$ )	$I_{CES}$ $I_{CES}$	— —	0.1 5.0	5.0 50	$\mu\text{Adc}$
Gate-Body Leakage Current ( $V_{GE} = \pm 15\text{ Vdc}$ , $V_{CE} = 0\text{ Vdc}$ )	$I_{GES}$	—	10	100	$\mu\text{Adc}$

## ON CHARACTERISTICS

Collector-to-Emitter On-State Voltage ( $V_{GE} = 15\text{ Vdc}$ , $I_C = 0.3\text{ Adc}$ ) ( $V_{GE} = 15\text{ Vdc}$ , $I_C = 0.3\text{ Adc}$ , $T_C = 125^\circ\text{C}$ )	$V_{CE(on)}$	— —	1.6 1.5	2.0 —	Vdc
Gate Threshold Voltage ( $V_{CE} = V_{GE}$ , $I_C = 250\ \mu\text{Adc}$ ) Threshold Temperature Coefficient (Negative)	$V_{GE(th)}$	3.5 —	— 6.0	6.0 —	Vdc mV/ $^\circ\text{C}$
Forward Transconductance ( $V_{CE} = 10\text{ Vdc}$ , $I_C = 0.5\text{ Adc}$ )	$g_{fe}$	0.3	0.42	—	Mhos

## DYNAMIC CHARACTERISTICS

Input Capacitance	$(V_{CE} = 20\text{ Vdc}$ , $V_{GE} = 0\text{ Vdc}$ , $f = 1.0\text{ MHz}$ )	$C_{ies}$	—	75	100	pF
Output Capacitance		$C_{oes}$	—	11	20	
Transfer Capacitance		$C_{res}$	—	1.6	5.0	

## DIODE CHARACTERISTICS

Diode Forward Voltage Drop ( $I_{EC} = 0.3\text{ Adc}$ ) ( $I_{EC} = 0.3\text{ Adc}$ , $T_C = 125^\circ\text{C}$ ) ( $I_{EC} = 0.1\text{ Adc}$ ) ( $I_{EC} = 0.1\text{ Adc}$ , $T_C = 125^\circ\text{C}$ )	$V_{FEC}$	— — — —	5.0 5.2 2.3 2.3	6.0 — 3.0 —	Vdc	
Reverse Recovery Time	$(I_F = 0.4\text{ Adc}$ , $V_R = 300\text{ Vdc}$ , $dI_F/dt = 10\text{ A}/\mu\text{s}$ )	$t_{rr}$	—	150	—	ns
Reverse Recovery Stored Charge		$Q_{RR}$	—	35	—	$\mu\text{C}$

## SWITCHING CHARACTERISTICS (1)

Turn-Off Delay Time	$(V_{CC} = 300\text{ Vdc}$ , $I_C = 0.4\text{ Adc}$ , $V_{GE} = 15\text{ Vdc}$ , $L = 3.0\text{ mH}$ , $R_G = 25\ \Omega$ , $dV/dt = 1000\text{ V}/\mu\text{s}$ ) Energy losses include "tail"	$t_{d(off)}$	—	28	—	ns
Fall Time		$t_f$	—	150	—	
Turn-Off Switching Loss		$E_{off}$	—	3.25	4.25	
Turn-Off Delay Time	$(V_{CC} = 300\text{ Vdc}$ , $I_C = 0.4\text{ Adc}$ , $V_{GE} = 15\text{ Vdc}$ , $L = 3.0\text{ mH}$ , $R_G = 25\ \Omega$ , $T_C = 125^\circ\text{C}$ , $dV/dt = 1000\text{ V}/\mu\text{s}$ ) Energy losses include "tail"	$t_{d(off)}$	—	21	—	ns
Fall Time		$t_f$	—	280	—	
Turn-Off Switching Loss		$E_{off}$	—	8.0	10	
Gate Charge	$(V_{CC} = 300\text{ Vdc}$ , $I_C = 0.3\text{ Adc}$ , $V_{GE} = 15\text{ Vdc}$ )	$Q_T$	—	6.4	—	nC

(1) Pulse Test: Pulse Width  $\leq 300\ \mu\text{s}$ , Duty Cycle  $\leq 2\%$ .

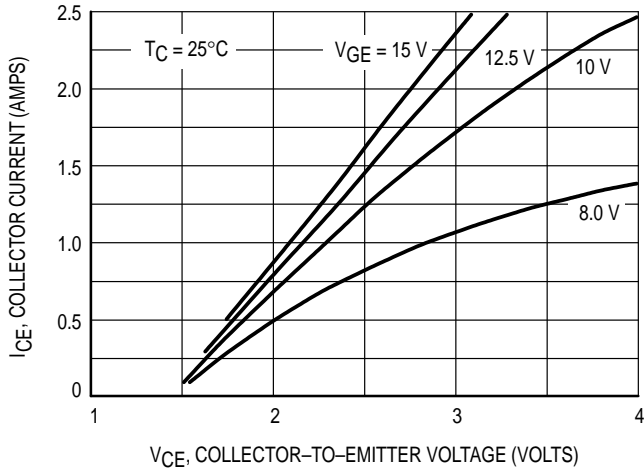

Figure 1. Saturation Characteristics

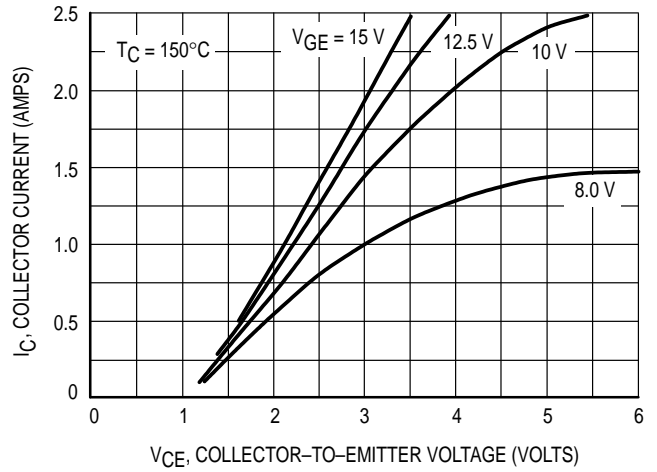

Figure 2. Saturation Characteristics

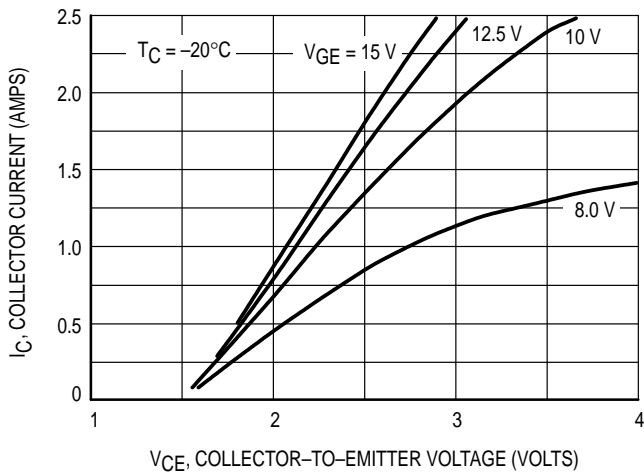

Figure 3. Saturation Characteristics

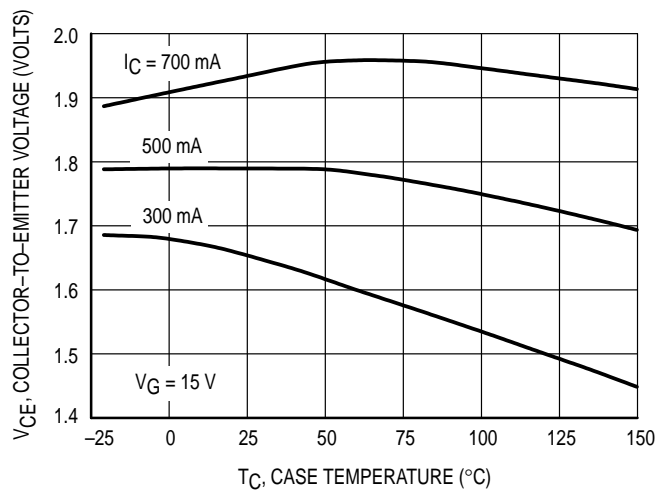

Figure 4. Collector-To-Emitter Saturation Voltage versus Case Temperature

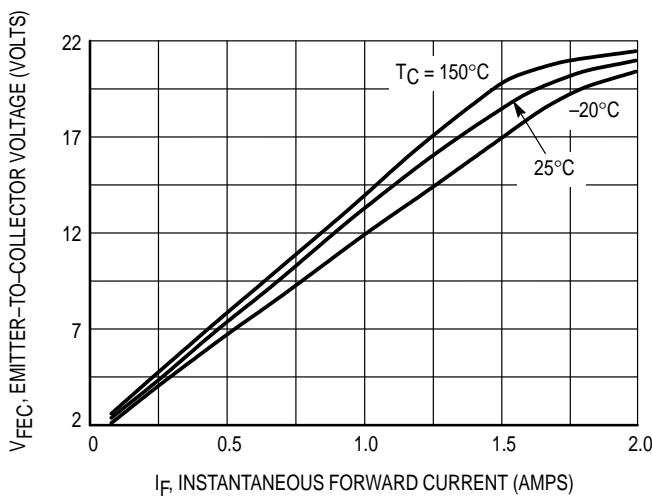

Figure 5. Diode Forward Voltage Drop

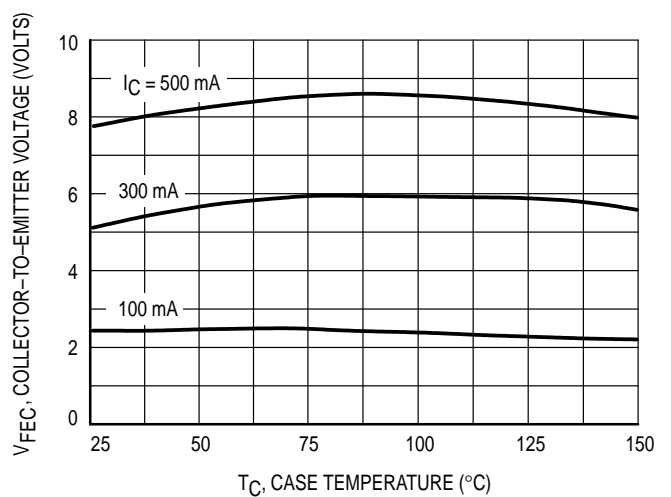

Figure 6. Diode Forward Voltage versus Case Temperature

# MGS05N60D

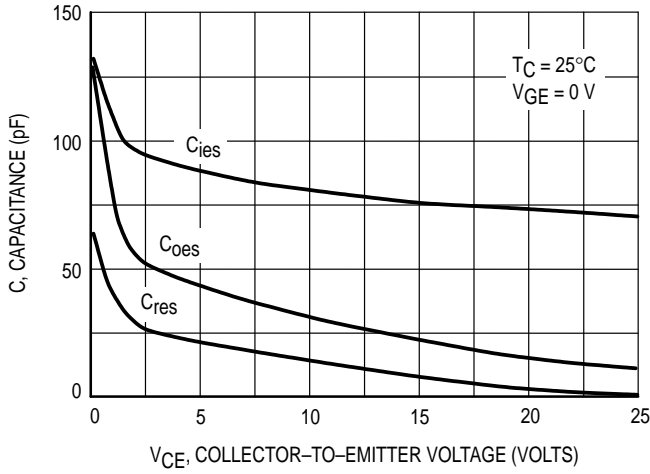

Figure 7. Capacitance Variation

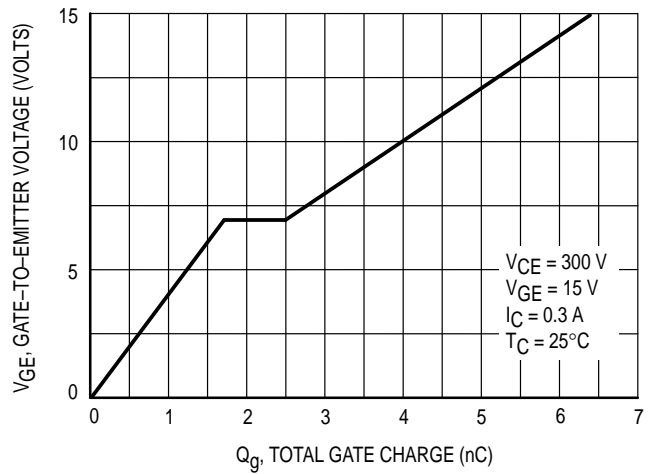

Figure 8. Gate-To-Emitter Voltage versus Total Charge

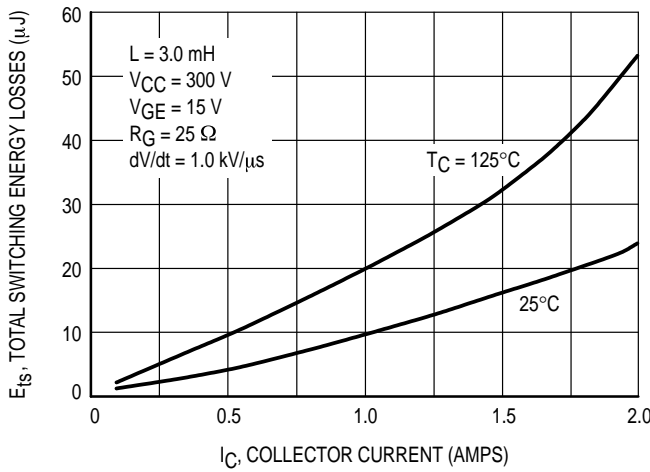

Figure 9. Total Switching Losses versus Collector Current

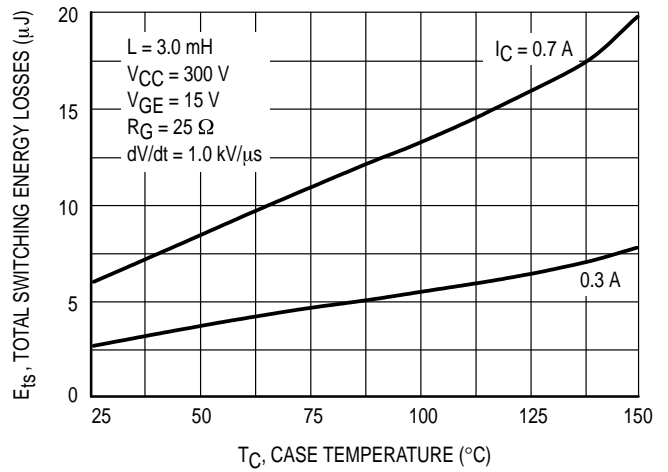

Figure 10. Total Switching Losses versus Case Temperature

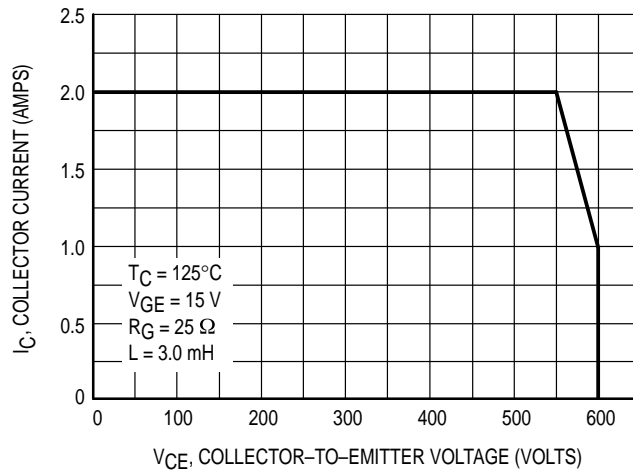

Figure 11. Minimum Turn-Off Safe Operating Area

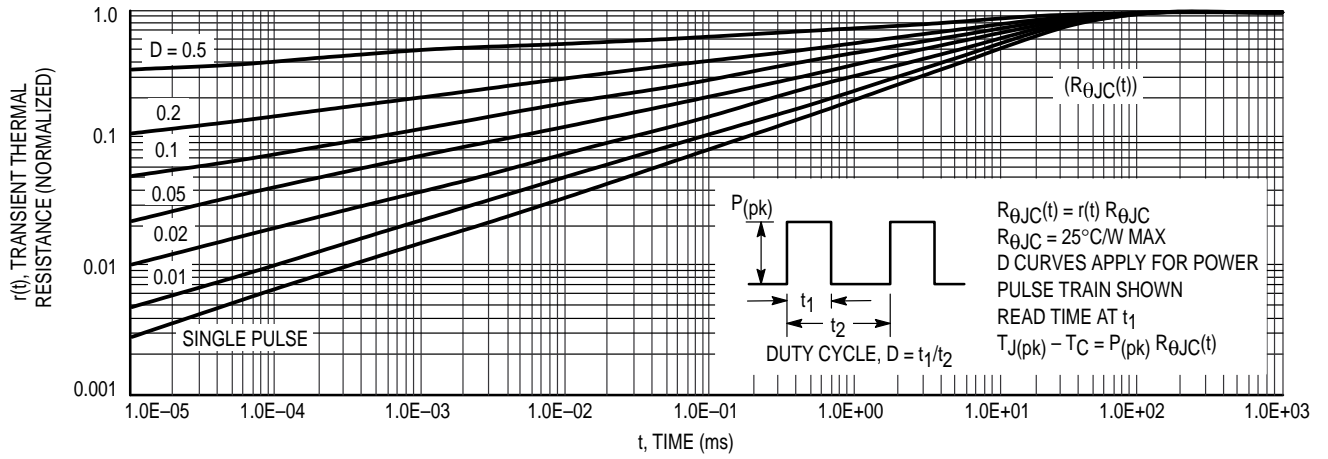
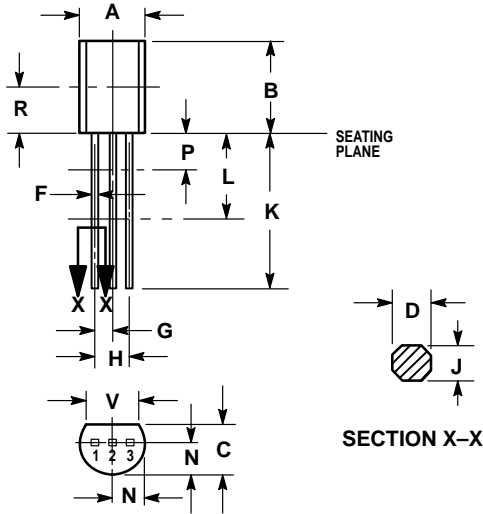

Figure 12. Typical Thermal Response

PACKAGE DIMENSIONS



- NOTES:
1. DIMENSIONING AND TOLERANCING PER ANSI Y14.5M, 1982.
  2. CONTROLLING DIMENSION: INCH.
  3. CONTOUR OF PACKAGE BEYOND DIMENSION R IS UNCONTROLLED.
  4. DIMENSION F APPLIES BETWEEN P AND L. DIMENSIONS D AND J APPLY BETWEEN L AND K MINIMUM. LEAD DIMENSION IS UNCONTROLLED IN P AND BEYOND DIMENSION K MINIMUM.

DIM	INCHES		MILLIMETERS	
	MIN	MAX	MIN	MAX
A	0.175	0.205	4.44	5.21
B	0.290	0.310	7.37	7.87
C	0.125	0.165	3.18	4.19
D	0.018	0.022	0.46	0.56
F	0.016	0.019	0.41	0.48
G	0.045	0.055	1.15	1.39
H	0.095	0.105	2.42	2.66
J	0.018	0.024	0.46	0.61
K	0.500	—	12.70	—
L	0.250	—	6.35	—
N	0.080	0.105	2.04	2.66
P	—	0.100	—	2.54
R	0.135	—	3.43	—
V	0.135	—	3.43	—

- STYLE 35:
- PIN 1. GATE
  - COLLECTOR
  - EMITTER

CASE 029-05  
TO-226AE  
ISSUE AD

Motorola reserves the right to make changes without further notice to any products herein. Motorola makes no warranty, representation or guarantee regarding the suitability of its products for any particular purpose, nor does Motorola assume any liability arising out of the application or use of any product or circuit, and specifically disclaims any and all liability, including without limitation consequential or incidental damages. "Typical" parameters which may be provided in Motorola data sheets and/or specifications can and do vary in different applications and actual performance may vary over time. All operating parameters, including "Typicals" must be validated for each customer application by customer's technical experts. Motorola does not convey any license under its patent rights nor the rights of others. Motorola products are not designed, intended, or authorized for use as components in systems intended for surgical implant into the body, or other applications intended to support or sustain life, or for any other application in which the failure of the Motorola product could create a situation where personal injury or death may occur. Should Buyer purchase or use Motorola products for any such unintended or unauthorized application, Buyer shall indemnify and hold Motorola and its officers, employees, subsidiaries, affiliates, and distributors harmless against all claims, costs, damages, and expenses, and reasonable attorney fees arising out of, directly or indirectly, any claim of personal injury or death associated with such unintended or unauthorized use, even if such claim alleges that Motorola was negligent regarding the design or manufacture of the part. Motorola and are registered trademarks of Motorola, Inc. Motorola, Inc. is an Equal Opportunity/Affirmative Action Employer.

Mfax is a trademark of Motorola, Inc.

How to reach us:

USA/EUROPE/Locations Not Listed: Motorola Literature Distribution;  
P.O. Box 5405, Denver, Colorado 80217. 1-303-675-2140 or 1-800-441-2447

JAPAN: Nippon Motorola Ltd.: SPD, Strategic Planning Office, 141,  
4-32-1 Nishi-Gotanda, Shagawa-ku, Tokyo, Japan. 03-5487-8488

Customer Focus Center: 1-800-521-6274

Mfax™: RMFAX0@email.sps.mot.com – TOUCHTONE 1-602-244-6609  
Motorola Fax Back System – US & Canada ONLY 1-800-774-1848  
–http://sps.motorola.com/mfax/

ASIA/PACIFIC: Motorola Semiconductors H.K. Ltd.; 8B Tai Ping Industrial Park,  
51 Ting Kok Road, Tai Po, N.T., Hong Kong. 852-26629298

HOME PAGE: <http://motorola.com/sps/>

