

Dual High-Voltage Schottky Barrier Rectifiers

PRODUCT SUMMARY

Reverse Voltage 90 to 100 Volts
Forward Current 20.0 Amperes

FEATURES

Plastic package has Underwriters Laboratory Flammability Classification 94V-0
Dual rectifier construction, positive center tap
Metal silicon junction, majority carrier conduction
Low power loss, high efficiency
Guardring for overvoltage protection
For use in low voltage, high frequency inverters, free wheeling, and polarity protection applications
High temperature soldering guaranteed:
250°C/10 seconds, 0.25" (6.35mm) from case

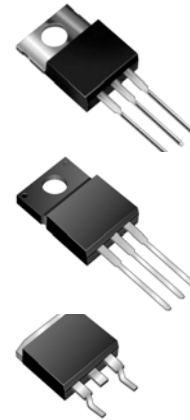

MECHANICAL DATA

Case: JEDEC TO-220AB, ITO-220AB & TO-263AB molded plastic body
Terminals: Plated leads, solderable per MIL-STD-750, Method 2026
Polarity: As marked
Mounting Position: Any
Mounting Torque: 10 in-lbs maximum
Weight: 0.08 ounce, 2.24 grams

ITO-220AB

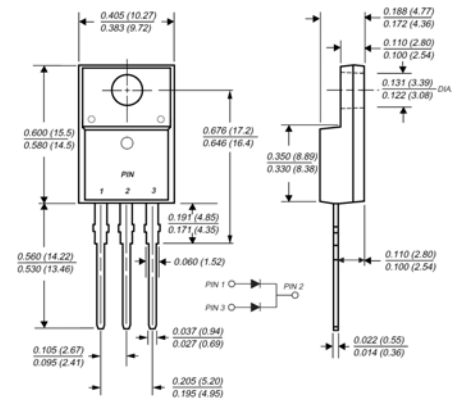

Pb Pb-free; RoHS-compliant

TO-220AB

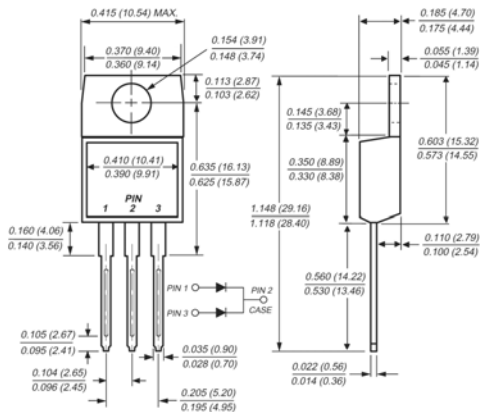

Mounting Pad Layout TO-263AB

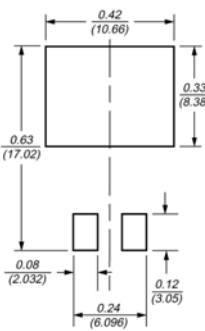

TO-263AB(D²PAK)

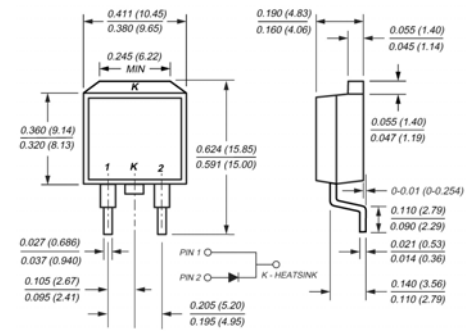

Dimensions in inches and (millimeters)

MAXIMUM RATINGS AND ELECTRICAL CHARACTERISTICS

($T_C = 25^\circ\text{C}$ unless otherwise noted)

Parameter	Symbol	MBR2090CT	MBR20100CT	Unit
Maximum repetitive peak reverse voltage	V_{RRM}	90	100	Volts
Working peak reverse voltage	V_{RWM}	90	100	Volts
Maximum DC blocking voltage	V_{DC}	90	100	Volts
Maximum average forward rectified current at $T_C=133^\circ\text{C}$	$I_{F(AV)}$	Total device		Amps
Per leg		20	10	
Peak forward surge current 8.3ms single half sine-wave superimposed on rated load (JEDEC Method) per leg	I_{FSM}	150		Amps
Peak repetitive reverse current per leg at $t_p = 2.0\mu\text{s}$, 1KHz	I_{RRM}	0.5		Amp
Voltage rate of change (rated V_R)	dv/dt	10,000		V/ μs
Maximum instantaneous forward voltage per leg (Note 4)	V_F	at $I_F=10\text{A}$, $T_C=25^\circ\text{C}$		Volts
at $I_F=10\text{A}$, $T_C=125^\circ\text{C}$		0.80		
at $I_F=20\text{A}$, $T_C=25^\circ\text{C}$		0.65		
at $I_F=20\text{A}$, $T_C=125^\circ\text{C}$		0.95		
Maximum reverse current per leg at working peak reverse voltage (Note 4)	I_R	$T_J=25^\circ\text{C}$		μA
		$T_J=100^\circ\text{C}$		mA
Typical thermal resistance per leg	$R_{\theta JA}$ $R_{\theta JC}$	MBR 60 / MBRF - / MBRB 60 MBR 2 / MBRF 3.5 / MBRB 2		$^\circ\text{C/W}$
RMS Isolation voltage (MBRF type only) from terminals to heatsink with $t = 1.0$ second, $\text{RH} \leq 30\%$	V_{ISOL}	4500 (Note 1) 3500 (Note 2) 1500 (Note 3)		Volts
Operating junction temperature range	T_J	-55 to +150		$^\circ\text{C}$
Storage temperature range	T_{STG}	-55 to +150		$^\circ\text{C}$

RATINGS AND CHARACTERISTIC CURVES

($T_A = 25^\circ\text{C}$ unless otherwise noted)

Fig. 1 - Forward Current Derating Curve

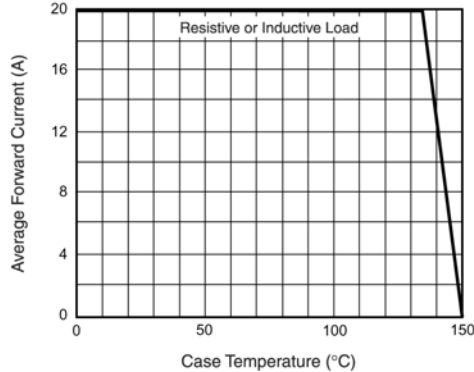

Fig. 2 - Maximum Non-Repetitive Peak Forward Surge Current

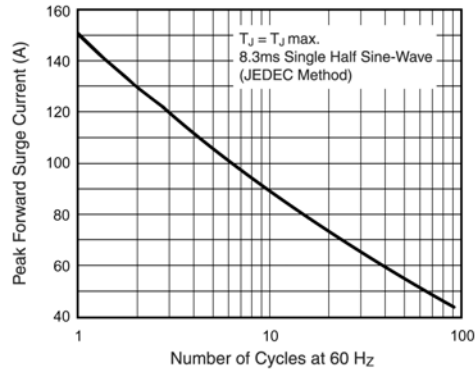

Fig. 3 - Typical Instantaneous Forward Characteristics

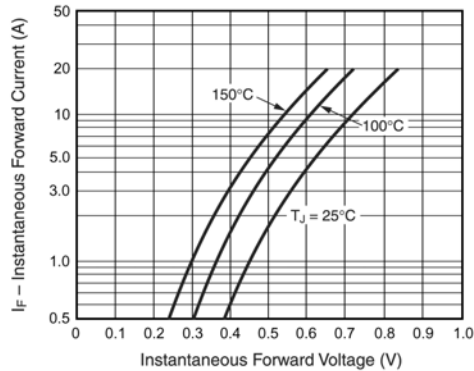

Fig. 4 - Typical Reverse Characteristics

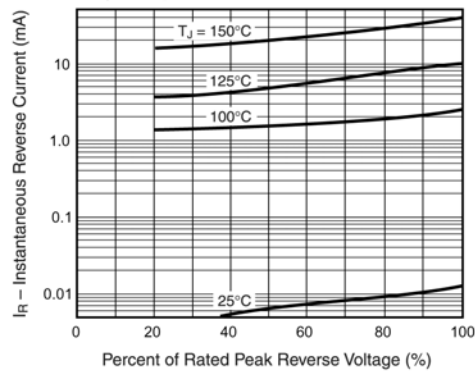
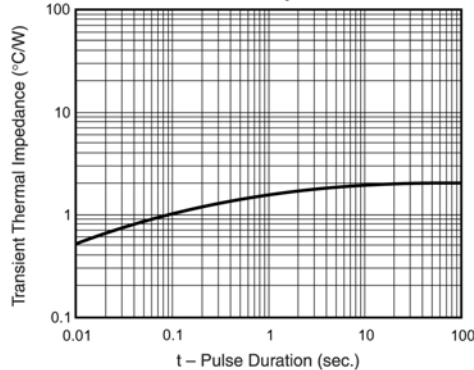

Fig. 5 - Typical Transient Thermal Impedance



Information furnished by Silicon Standard Corporation is believed to be accurate and reliable. However, Silicon Standard Corporation makes no guarantee or warranty, expressed or implied, as to the reliability, accuracy, timeliness or completeness of such information and assumes no responsibility for its use, or for infringement of any patent or other intellectual property rights of third parties that may result from its use. Silicon Standard reserves the right to make changes as it deems necessary to any products described herein for any reason, including without limitation enhancement in reliability, functionality or design. No license is granted, whether expressly or by implication, in relation to the use of any products described herein or to the use of any information provided herein, under any patent or other intellectual property rights of Silicon Standard Corporation or any third parties.