

Ultra low Power Consumption Low Dropout CMOS Voltage Regulators

General Description

The LN1121 series are precise, low power consumption, high voltage; positive voltage regulators manufactured using CMOS and laser trimming technologies. The series provides large currents with a significantly small dropout voltage. The LN1121 consists of a current limiter circuit, a driver transistor, a precision reference voltage and an error correction circuit. The series is compatible with low ESR ceramic capacitors. The current limiter's feedback circuit also operates as a short protect for the output current limiter and the output pin. Output voltage can be set internally by laser trimming technologies. It is selectable in 100mV increments within a range of 1.2V to 5.0V. SOT-89-3L, SOT-23-3L, SOT-353 and SOT-23-3B packages are available.

Applications

- Battery powered equipment
- Reference voltage sources
- Cameras, Video cameras
- Mobile phones
- Communication tools

Ordering Information

LN1121P ①②③④⑤

Designator	Symbol	Description	Designator	Symbol	Description
① ②	Integer	Output Voltage: e.g. ① =3, ② =0 ⇨ 3.0V	④	K	SOT353(SC70-5)
				V	SOT-23-3B
③	2	Accuracy: within $\pm 2\%$	⑤	R	Embossed Tape: Standard Feed
④	M	SOT-23-3L		L	Embossed Tape: Reverse Feed
		P	SOT89-3L		

Pin Configuration

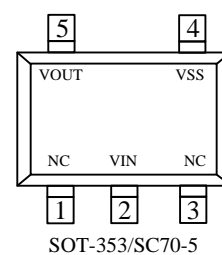
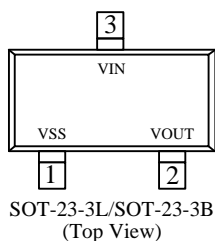
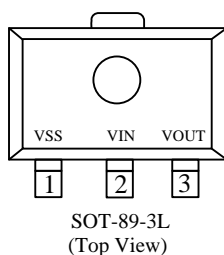

Features

- Output Voltage Range: 1.2V to 5.0V (selectable in 100mV steps)
- Highly Accurate: 2%
- Dropout Voltage: 160mV @ 100mA (3.0V type)
- Low Power Consumption: 1 μ A (TYP.)
- Maximum Output Current : 250mA ($V_{in} \geq V_{out} + 1V$)
- Internal protector: current limiter and short protector
- Small packages

Package

- SOT-89-3L
- SOT-353/SC70-5
- SOT-23-3L, SOT-23-3B

Pin Assignment

Pin Number			Pin Name	Function
SOT-353/SC70-5	SOT-23-3L/B	SOT-89-3L		
2	3	2	VIN	Supply Power
4	1	1	VSS	Ground
1,3	-	-	NC	No Connection
5	2	3	VOOUT	Voltage Output

Marking Rule

- SOT-89-3L, SOT-353, SOT-23-3L/B

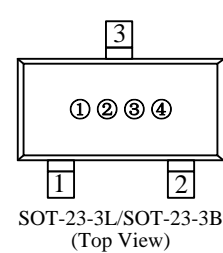
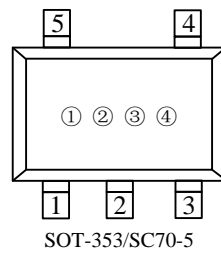
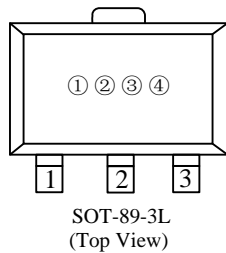

- ① Represents the product name

Symbol	Product Name
6/9/S	LN1121P◆◆◆◆◆

- ② Represents the range of output voltage

Output Voltage Range (V)	0.1~3.0	3.1~6.0	6.1~9.0
Symbol	5	6	7

- ③ Represents the Output Voltage

Symbol	Output Voltage (V)			Symbol	Output Voltage (V)		
0	-	3.1	-	F	1.6	4.6	-
1	-	3.2	-	H	1.7	4.7	-
2	-	3.3	-	K	1.8	4.8	-
3	-	3.4	-	L	1.9	4.9	-
4	-	3.5	-	M	2	5.0	-
5	-	3.6	-	N	2.1	5.1	-
6	-	3.7	-	P	2.2	5.2	-
7	-	3.8	-	R	2.3	5.3	-
8	-	3.9	-	S	2.4	5.4	-
9	-	4	-	T	2.5	5.5	-
A	-	4.1	-	U	2.6	5.6	-
B	1.2	4.2	-	V	2.7	5.7	-
C	1.3	4.3	-	X	2.8	5.8	-

Symbol	Output Voltage (V)			Symbol	Output Voltage (V)		
D	1.4	4.4	-	Y	2.9	5.9	-
E	1.5	4.5	-	Z	3	6.0	-

④ Represents the assembly lot no.

0~9, A~Z repeated (G, I, J, O, Q, W excepted)

■ Function Block Diagram

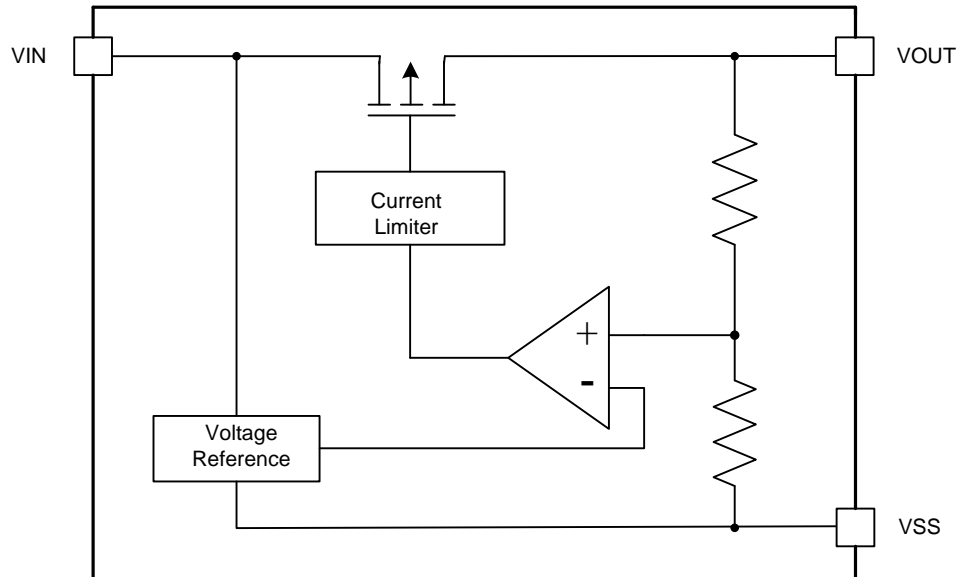

■ Absolute Maximum Ratings

Parameter	Symbol	Maximum Rating		Unit
Input Voltage	V_{IN}	$V_{SS}-0.3 \sim V_{SS}+6$		V
Output Current	V_{OUT}	$V_{SS}-0.3 \sim V_{IN}+0.3$		
Power Dissipation	P_D	SOT-23-3L, SOT-23-3LB	250	mW
		SOT353	250	
		SOT-89-3L	500	
Operating Ambient Temperature	T_{opr}	-40~+85		°C
Storage Temperature	T_{stg}	-40~+125		

Caution: The absolute maximum ratings are rated values exceeding which the product could suffer physical damage. These values must therefore not be exceeded under any conditions.

Typical Application Circuit

1、Basic circuit

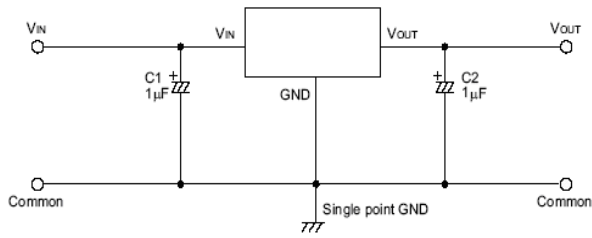

2、High output current positive voltage regulator

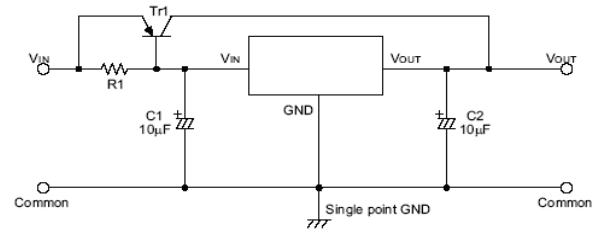

3、Circuit for increasing output voltage

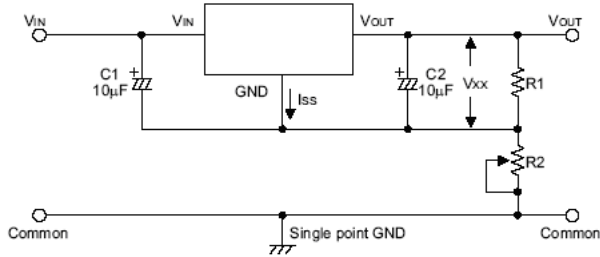

$$V_{OUT} = V_{XX} \left(1 + \frac{R2}{R1}\right) + I_{SS} R2$$

4、Circuit for increasing output voltage

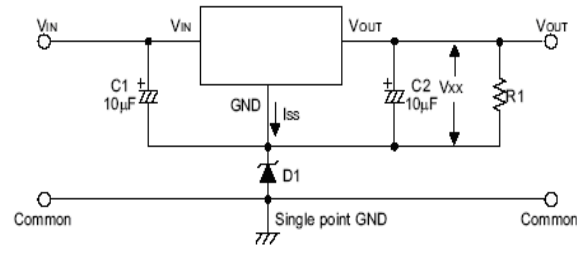

$$V_{OUT} = V_{XX} + V_{D1}$$

5、Constant current regulator

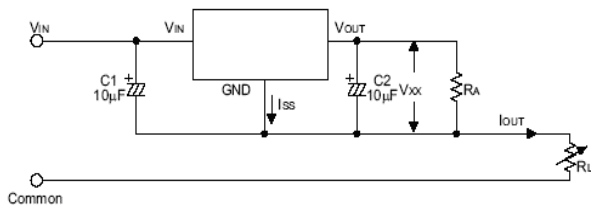

$$I_{OUT} = \frac{V_{XX}}{R_A} + I_{SS}$$

6、Dual supply

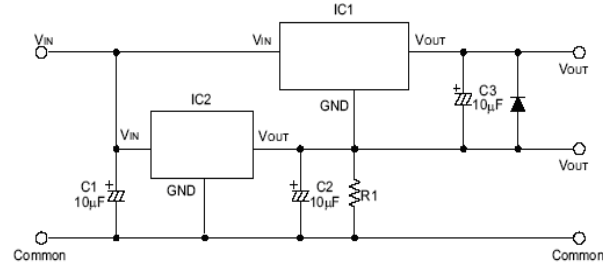

Caution : The above connection diagram and constant will not guarantee successful operation. Perform thorough evaluation using the actual application to set the constant.

Application Conditions

Input capacitor (CIN): 1.0µF or more

Output capacitor (CL): .01µF or more (tantalum capacitor)

Caution A general series regulator may oscillate, depending on the external components selected. Check that no oscillation occurs with the application using the above capacitor.

Test Circuits

Circuit ①

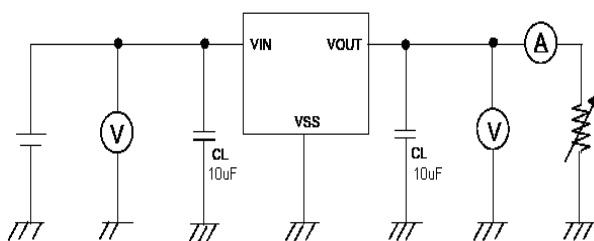

Circuit ②

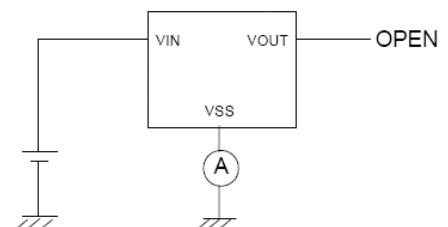

Electrical Characteristics

Item	Symbol	Condition	Min	Typ	Max	Unit	Circuit	
Output Voltage	$V_{OUT(E)1}$	$V_{IN} = V_{OUT(S)} + 1.0 \text{ V}$, $I_{OUT} = 10 \text{ mA}$	$V_{OUT(S)} \times 0.98$	$V_{OUT(S)}$	$V_{OUT(S)} \times 1.02$	V	1	
Output Current	I_{OUT}	$V_{IN} \geq V_{OUT(S)} + 1.0 \text{ V}$	280^{-1}	—	—	mA	1	
Dropout Voltage	V_{drop}	$I_{OUT} = 40 \text{ mA}$	$1.5 \text{ V} \leq V_{OUT(S)} \leq 2.5 \text{ V}$	—	0.18	0.24	V	1
			$2.6 \text{ V} \leq V_{OUT(S)} \leq 3.3 \text{ V}$	—	0.12	0.20		
			$3.4 \text{ V} \leq V_{OUT(S)} \leq 5.0 \text{ V}$	—	0.08	0.16		
Line Regulations	$\frac{\Delta V_{OUT1}}{\Delta V_{IN} \cdot V_{OUT}}$	$V_{OUT(S)} + 0.5 \text{ V} \leq V_{IN} \leq 5.5 \text{ V}$ $I_{OUT} = 10 \text{ mA}$	—	0.05	0.2	%/V	1	
Input Voltage	ΔV_{OUT2}	$V_{IN} = V_{OUT(S)} + 1.0 \text{ V}$ $1.0 \text{ mA} \leq I_{OUT} \leq 50 \text{ mA}$	—	20	40	mV	1	
Output Voltage Temperature Characteristics	$\frac{\Delta V_{OUT}}{\Delta T_a \cdot V_{OUT}}$	$V_{IN} = V_{OUT(S)} + 1.0 \text{ V}$, $I_{OUT} = 10 \text{ mA}$ $-40^\circ\text{C} \leq T_a \leq 85^\circ\text{C}$	—	± 100	—	ppm/ $^\circ\text{C}$	1	
Supply Current	I_{SS1}	$V_{IN} = V_{OUT(S)} + 1.0 \text{ V}$	0.8	1	2	μA	2	
Input Voltage	V_{IN}	—	1.8	—	6	V	—	
Ripple-Rejection	RR	$V_{IN} = V_{OUT(S)} + 1.0 \text{ V}$, $f = 1.0 \text{ kHz}$ $V_{rip} = 0.5 \text{ V}_{rms}$, $I_{OUT} = 30 \text{ mA}$	—	40	—	dB	1	
Short current	I_{short}	$V_{IN} = V_{OUT(S)} + 1.5 \text{ V}$,	—	15	—	mA	1	
Current Limiter	I_{lim}	$V_{IN} = V_{OUT(S)} + 1.5 \text{ V}$,	—	380	—	mA	1	

Note1: Lower input voltage and the output voltage, maximum output current will decrease. Example:
 $I_{OUT}(\text{max}) = 150 \text{ mA} @ (V_{IN} = 2.5 \text{ V}, V_{OUT} = 1.5 \text{ V})$

Typical Performance Characteristics (3.0V output)

1、Output Voltage vs. Output Current

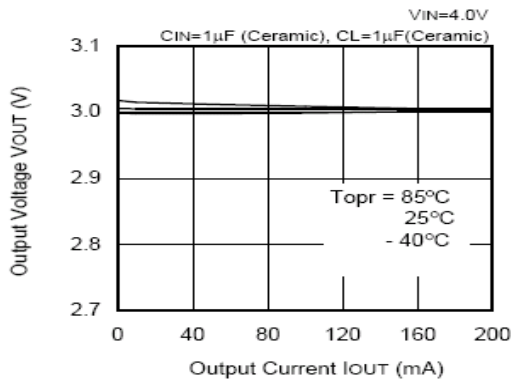

2、Output Voltage vs. Input Voltage

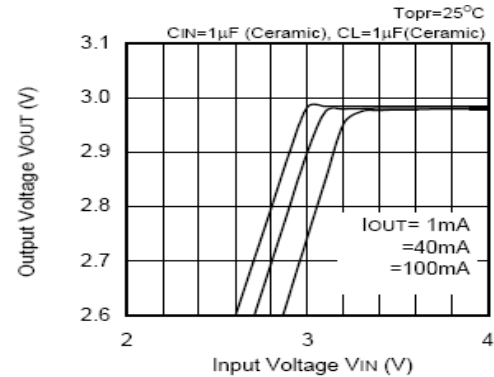

3、Dropout Voltage vs. Output Current

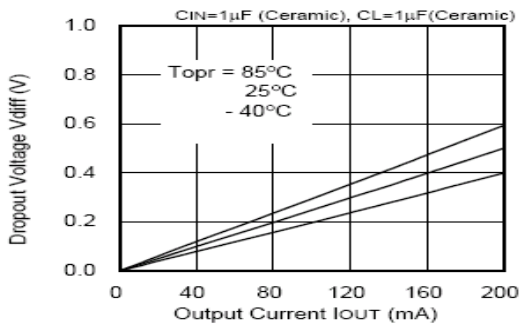

4、Dropout Voltage vs. Output Voltage

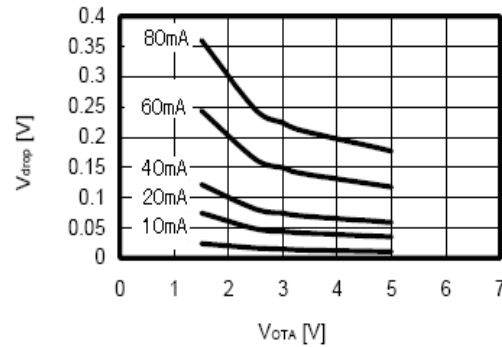

5、Output Voltage vs. Ambient Temperature

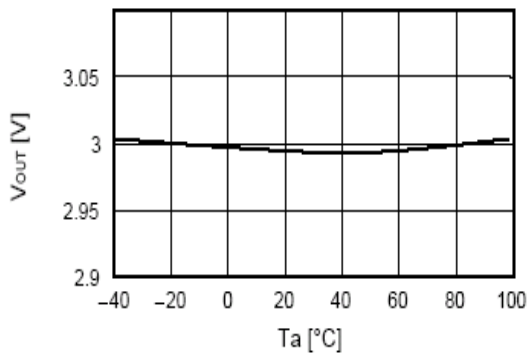

6、Ripple Rejection Rate

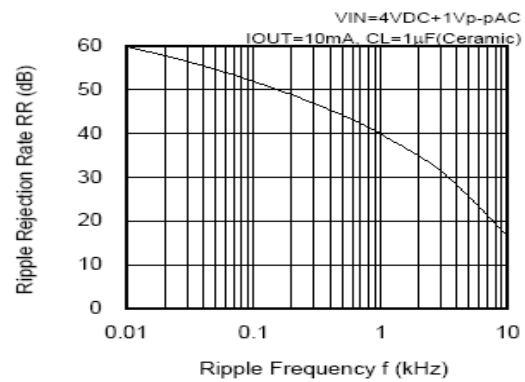

7、Transient Response

Input Transient Response

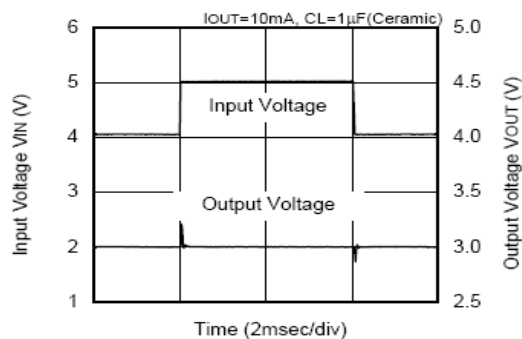

Load Transient Response

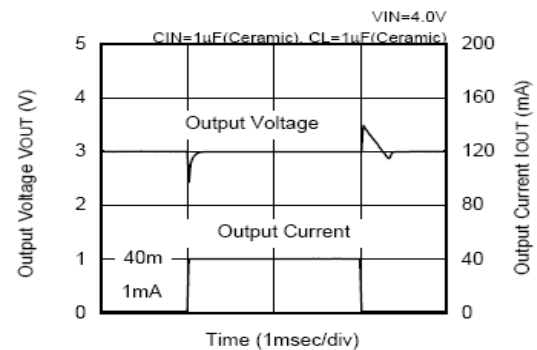

■ Package Information

- SOT-89-3L

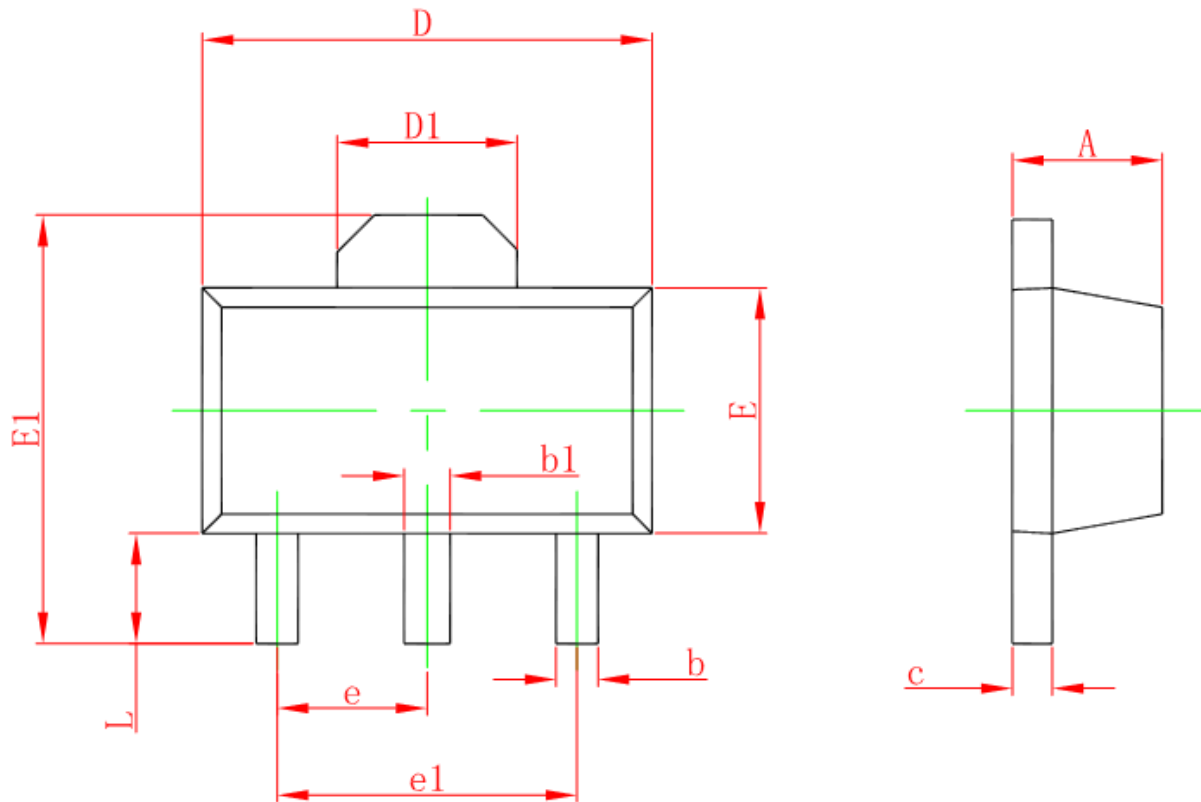

Symbol	Dimensions In Millimeters		Dimensions In Inches	
	Min	Max	Min	Max
A	1.400	1.600	0.055	0.063
b	0.320	0.520	0.013	0.020
b1	0.400	0.580	0.016	0.023
c	0.350	0.440	0.014	0.017
D	4.400	4.600	0.173	0.181
D1	1.550 REF.		0.061 REF.	
E	2.300	2.600	0.091	0.102
E1	3.940	4.250	0.155	0.167
e	1.500 TYP.		0.060 TYP.	
e1	3.000 TYP.		0.118 TYP.	
L	0.900	1.200	0.035	0.047

● SOT-353/SC70-5

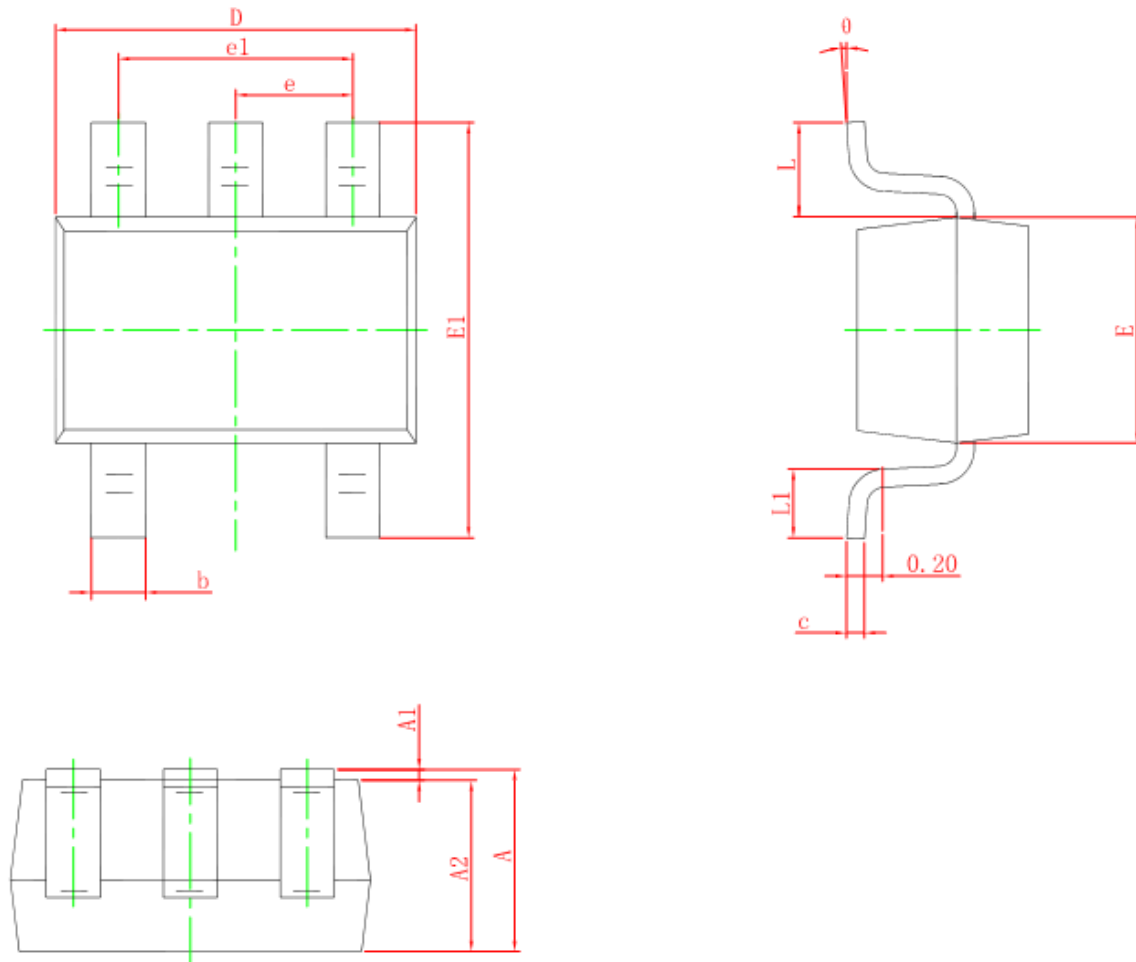

Symbol	Dimensions In Millimeters		Dimensions In Inches	
	Min	Max	Min	Max
A	0.900	1.100	0.035	0.043
A1	0.000	0.100	0.000	0.004
A2	0.900	1.000	0.035	0.039
b	0.150	0.350	0.006	0.014
c	0.080	0.150	0.003	0.006
D	2.000	2.200	0.079	0.087
E	1.150	1.350	0.045	0.053
E1	2.150	2.450	0.085	0.096
e	0.650 TYP		0.026 TYP	
e1	1.200	1.400	0.047	0.055
L	0.525 REF		0.021 REF	
L1	0.260	0.460	0.010	0.018
θ	0°	8°	0°	8°

● SOT-23-3L

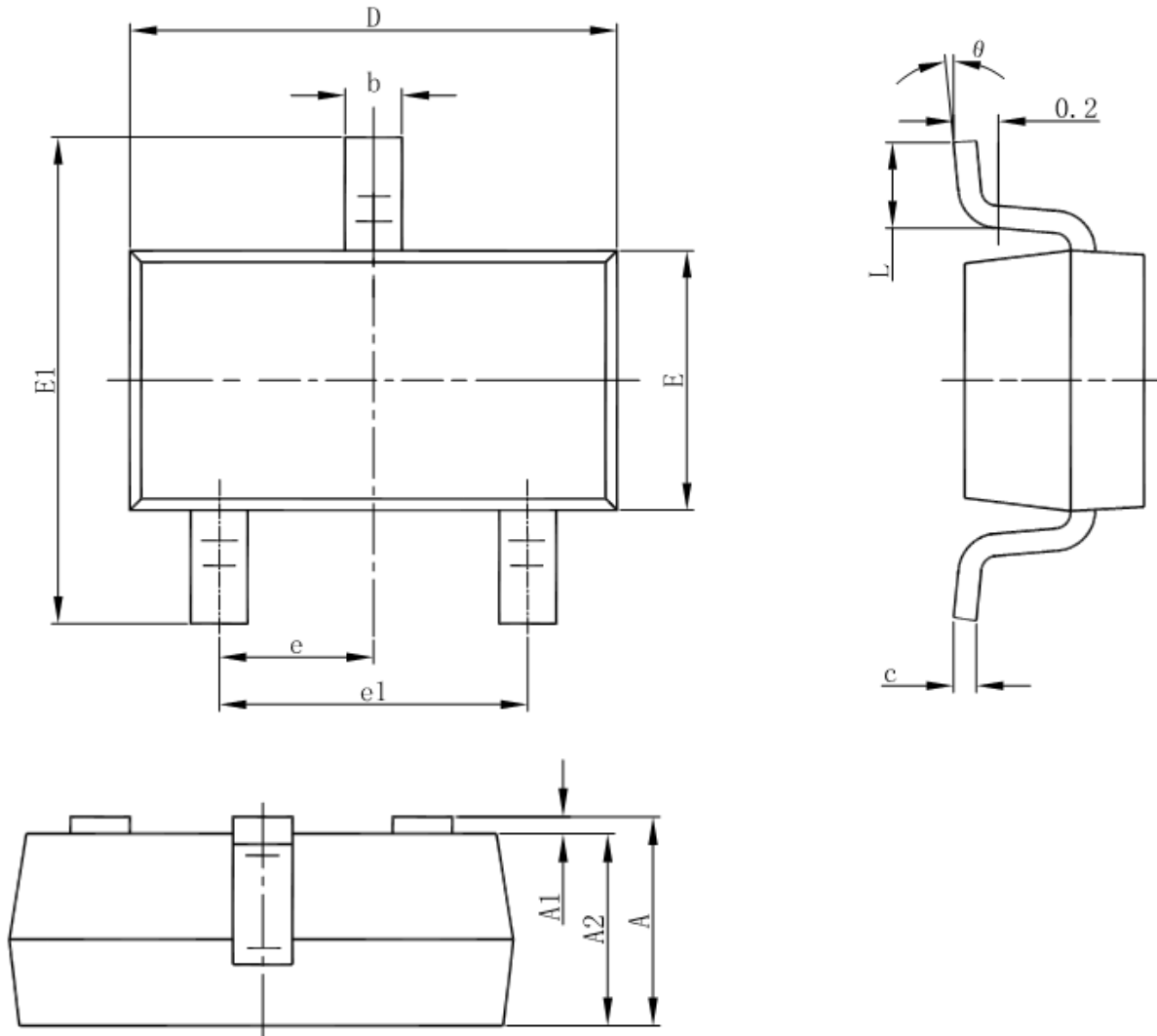

Symbol	Dimensions In Millimeters		Dimensions In Inches	
	Min	Max	Min	Max
A	1.050	1.250	0.041	0.049
A1	0.000	0.100	0.000	0.004
A2	1.050	1.150	0.041	0.045
b	0.300	0.500	0.012	0.020
c	0.100	0.200	0.004	0.008
D	2.820	3.020	0.111	0.119
E	1.500	1.700	0.059	0.067
E1	2.650	2.950	0.104	0.116
e	0.950(BSC)		0.037(BSC)	
e1	1.800	2.000	0.071	0.079
L	0.300	0.600	0.012	0.024
theta	0°	8°	0°	8°

● SOT-23-3B

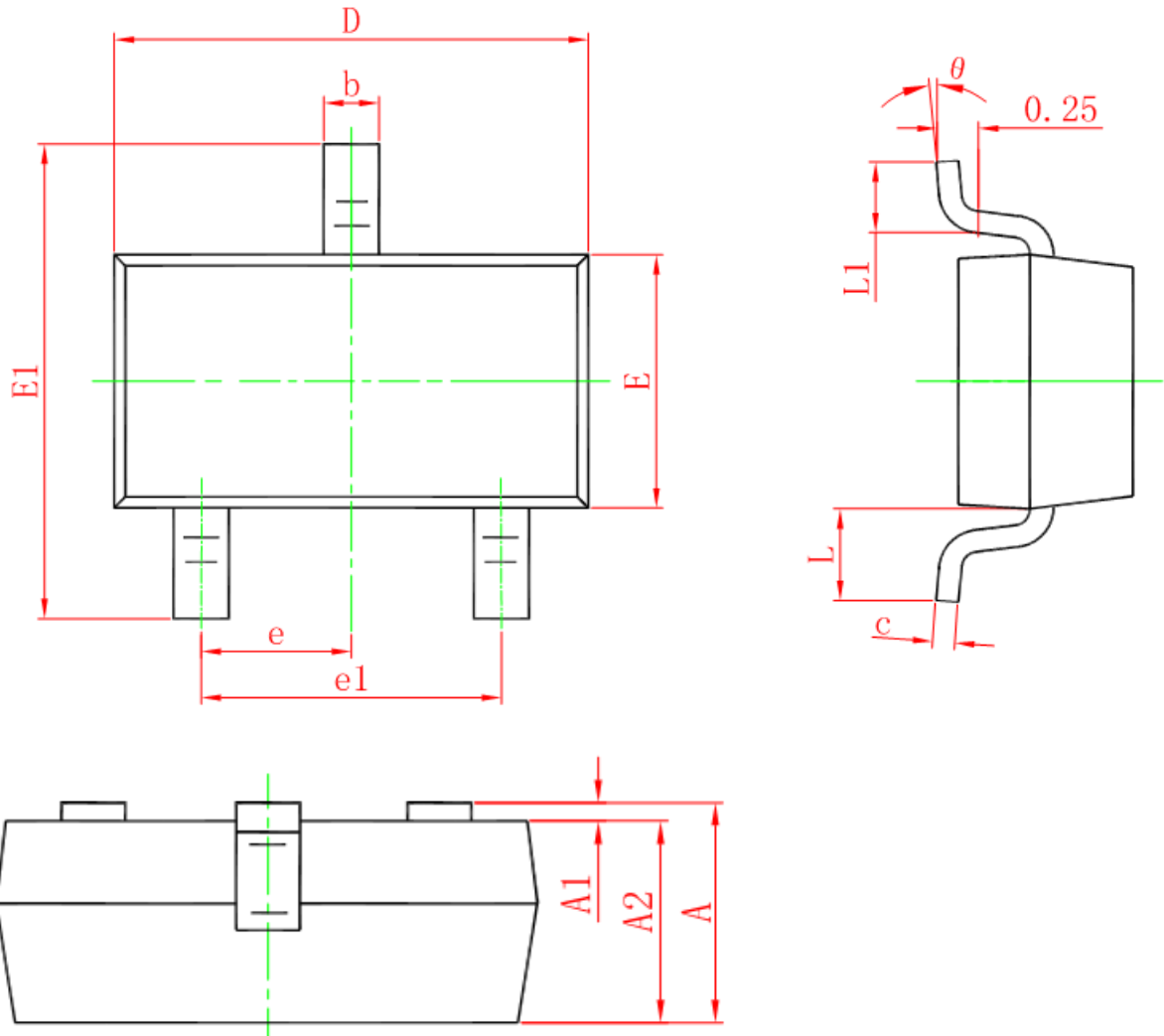

Symbol	Dimensions In Millimeters		Dimensions In Inches	
	Min.	Max.	Min.	Max.
A	0.900	1.150	0.035	0.045
A1	0.000	0.100	0.000	0.004
A2	0.900	1.050	0.035	0.041
b	0.300	0.500	0.012	0.020
c	0.080	0.150	0.003	0.006
D	2.800	3.000	0.110	0.118
E	1.200	1.400	0.047	0.055
E1	2.250	2.550	0.089	0.100
e	0.950 TYP.		0.037 TYP.	
e1	1.800	2.000	0.071	0.079
L	0.550 REF.		0.022 REF.	
L1	0.300	0.500	0.012	0.020
θ	0°	8°	0°	8°