



SANYO Semiconductors

DATA SHEET

LA47516 — Monolithic Linear IC Four-Channel 50W BTL Power Amplifier for Car Stereo Systems

Overview

The LA47516 is a four-channel 50W BTL power amplifier IC for car stereo systems. The output stage uses a pure complementary format with a V-PNP transistor on the upper side and an NPN transistor on the lower side, making it possible to obtain high power output and excellent sound quality.

This IC features an extensive set of functions required in car audio systems, including a standby switch, muting function, and a full complement of protection circuits.

Features

- Maximum output : 50W×4 (at $V_{CC} = 14.4V$, $R_L = 4\Omega$)
- Very low external component count

Functions

- On-chip offset detector
- Electrically driven mirror noise countermeasure pin provided
- Mute function
- Standby switch
- Full compliment of protection circuits (including shorting to the power supply, shorting to ground, load short-circuit, overvoltage, thermal protection)

Usage Notes

Note 1 : This IC must not be connected incorrectly. Incorrect connection can lead to damage to or destruction of the IC.

Note 2 : The protection circuits can temporarily prevent damage to the IC from abnormal states such as incorrect output line connections, but they cannot guarantee that the IC will not be destroyed.

In particular, these protection circuits do not function outside the guaranteed operating ranges, and incorrect connection of the outputs can lead to destruction of the IC.

Specifications

Maximum Ratings at $T_a = 25^\circ C$

Parameter	Symbol	Conditions	Ratings	Unit
Maximum supply voltage	$V_{CC\ max1}$	No signal, $t = 1\ \text{minute}$	26	V
	$V_{CC\ max2}$	With signal	18	V

Continued on next page.

■ Any and all SANYO Semiconductor products described or contained herein do not have specifications that can handle applications that require extremely high levels of reliability, such as life-support systems, aircraft's control systems, or other applications whose failure can be reasonably expected to result in serious physical and/or material damage. Consult with your SANYO Semiconductor representative nearest you before using any SANYO Semiconductor products described or contained herein in such applications.

■ SANYO Semiconductor assumes no responsibility for equipment failures that result from using products at values that exceed, even momentarily, rated values (such as maximum ratings, operating condition ranges, or other parameters) listed in products specifications of any and all SANYO Semiconductor products described or contained herein.

SANYO Semiconductor Co., Ltd.

TOKYO OFFICE Tokyo Bldg., 1-10, 1 Chome, Ueno, Taito-ku, TOKYO, 110-8534 JAPAN

LA47516

Continued from preceding page.

Parameter	Symbol	Conditions	Ratings	Unit
Maximum output current	$I_{O \text{ peak}}$		4.5	A
Allowable power dissipation	$P_d \text{ max}$	With a infinity large heat sink (See note.)	50	W
Operating temperature	T_{op}		-40 to +85	°C
Storage temperature	T_{stg}		-40 to +150	°C
Junction-to-case thermal resistance	θ_{j-c}		1	°C/W

Note : Power consumption (P_d), junction-to-case thermal resistance (θ_{j-c}), heat sink thermal resistance (θ_f), junction temperature (T_j), case temperature (T_c), and ambient temperature (T_a) have the relationship shown in the following equation.

$$T_j = P_d (\theta_{j-c} + \theta_f) + T_a$$

$$= P_d \times \theta_{j-c} + T_c, \quad *T_c = P_d \times \theta_f + T_a \quad \text{However, } T_j \text{ max is limited by } T_{stg \text{ max}} (150^\circ\text{C}).$$

Operating Conditions at $T_a = 25^\circ\text{C}$

Parameter	Symbol	Conditions	Ratings	Unit
Recommended supply voltage	V_{CC}		14.4	V
Recommended load resistance	R_L		4	Ω
Operating supply voltage range	$V_{CC \text{ op}}$	$P_d \text{ max}$ shall not be exceeded.	9 to 18	V

Electrical Characteristics at $T_a = 25^\circ\text{C}$, $V_{CC} = 14.4\text{V}$, $f = 1\text{kHz}$, $R_L = 4\Omega$, $R_g = 600\Omega$

Parameter	Symbol	Conditions	Ratings			Unit
			min	typ	max	
Quiescent current	I_{CCO}	$R_L = \infty$, $R_g = 0$		200	350	mA
Standby current	I_{st}	$V_{st} = 0\text{V}$			10	μA
Output offset voltage	$V_n \text{ offset}$	$R_g = 0$	-150		+150	mV
Voltage gain	V_G	$V_O = 0\text{dBm}$	31	32	33	dB
Voltage gain difference	ΔV_G		-1		+1	dB
Output power	P_{O1}	THD = 10%	24	29		W
	$P_{O \text{ max}1}$	$V_{CC} = 13.7\text{V}$, $V_{IN} = 2.5\text{Vrms}$		43		W
	$P_{O \text{ max}2}$	$V_{IN} = 2.5\text{Vrms}$		48		W
Total harmonic distortion	THD	$P_O = 4\text{W}$		0.1	0.4	%
Channel separation	CHsep	$V_O = 0\text{dBm}$, $R_g = 10\text{k}\Omega$	55	65		dB
Ripple rejection ratio	SVRR	$f_r = 100\text{Hz}$, $V_r = 0\text{dBm}$, $R_g = 0$ B.P.F = 20Hz to 20kHz	50	70		dB
Output noise voltage	V_{NO}	$R_g = 0$, B.P.F = 20Hz to 20kHz		80	200	μVrms
Mute attenuation	M_a	$V_O = 20\text{dBm}$	70	90		dB

*0dBm = 0.775Vrms

Package Dimensions

unit : mm (typ)

3236A

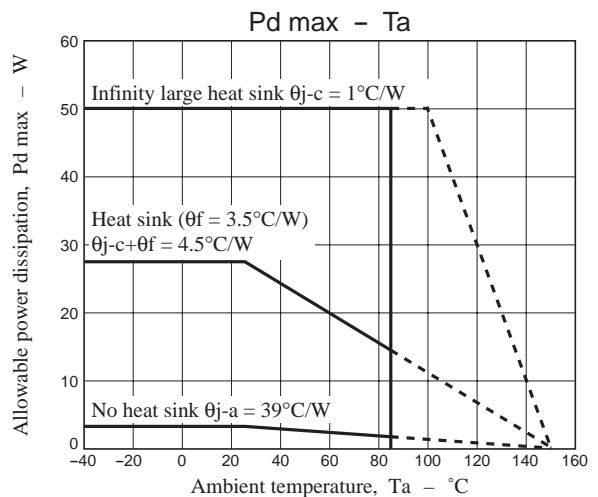
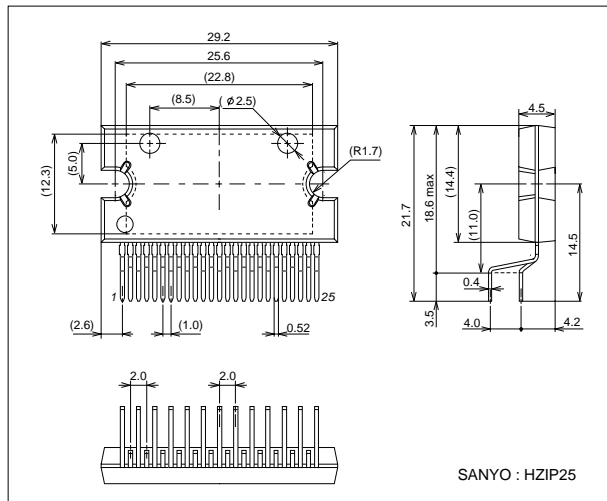

Block and Test Circuit Diagram

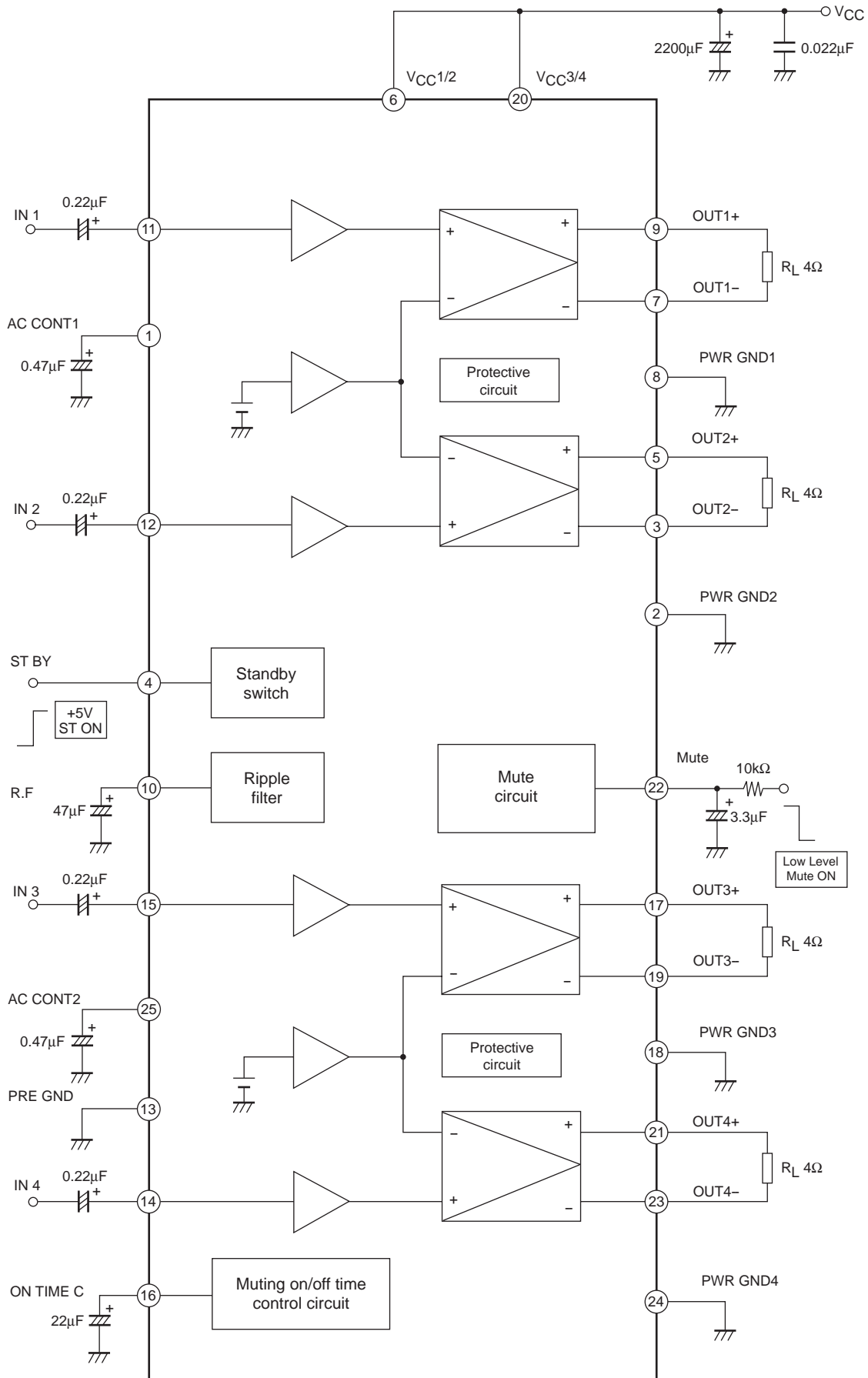

Note : The components and constant values in the test circuit are used for confirmation of characteristics and do not guarantee that the application equipment will be free from malfunction or trouble

Description of Operation

1. Standby switch function (pin 4)

The pin 4 threshold voltage is set to $2V_{BE}$; the amplifier turns on when $V_{st} = 2.0V$ or higher, and off when $V_{st} = 0.7V$ or lower. Note that pin 4 requires an operating current of $40\mu A$ or higher.

Note : Do not ground the output with the Pin 4 voltage at approximately 1.4V. In addition, do not give the Pin 4 voltage a time constant.

2. Muting function

The audio can be muted by connecting pin 22 to ground through a $10k\Omega$ resistance. This sets the IC to the muted state. The mute time constant is determined by the external capacitor and resistor constants. The recommended external constants are $C = 3.3\mu F$, $R = 10k\Omega$.

3. Oscillation stability

Parasitic oscillation may be induced depending on the board layout.

Countermeasures against oscillation can be taken by adding the following parts.

Note that the following are only examples for reference, and that the optimum capacitance values must be confirmed in the mounted condition for each set.

- Connect a Mylar capacitor ($0.033\mu F$) between the BTL outputs.
- Connect a capacitor and a resistor ($0.1\mu F$ and 2.2Ω in series) between each output and GND.

4. Sound quality (low frequencies)

The frequency response in the low frequency range can be improved by varying the capacitance value of the input capacitor. The recommended value is $2.2\mu F$ or less.

5. Impulse noise

This IC includes a function for preventing impulse noise from appearing in the output. The effect of this function can be improved by using it in combination with the muting function.

- When turning on the amplifier, turn the power supply and the mute function on at the same time.
Then turn the mute function off after the output current potential has stabilized.
- When turning off the amplifier, first turn on the muting function and then turn off the power.

6. Electric mirror noise suppression measures

A capacitor about twice the size of the input capacitors must be used for the capacitor between pins 1 and 25 that is used to minimize noise from the electrically driven mirror.

In the sample application circuit, a $0.47\mu F$ capacitor is used for $0.22\mu F$ input capacitors.

Note that the capacitor connected between pins 1 and 25 must be connected to the same pre-ground as the input capacitors.

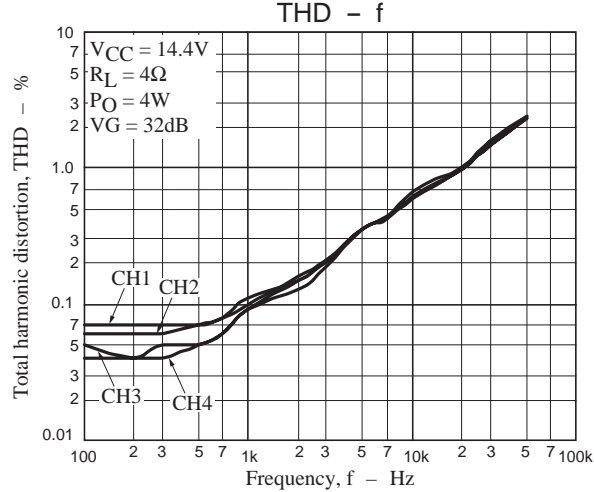
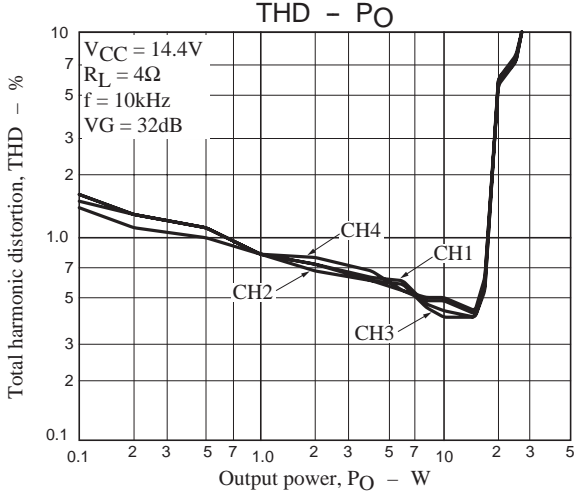
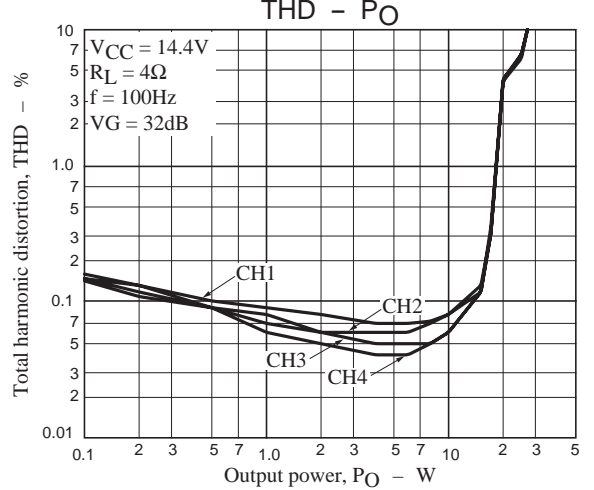
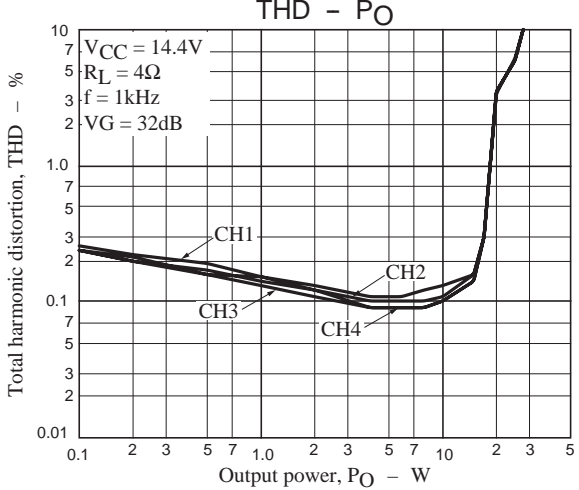
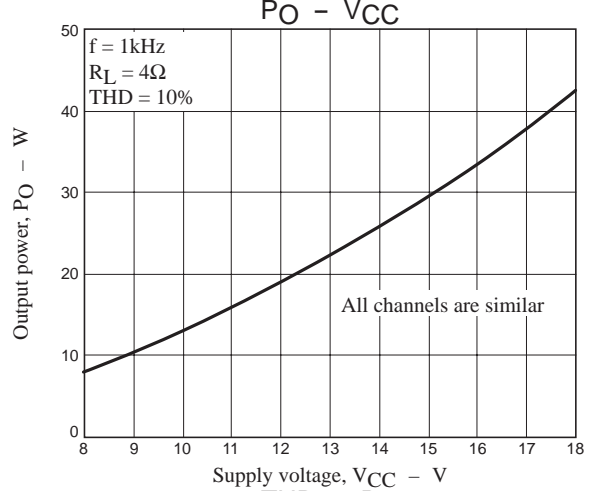
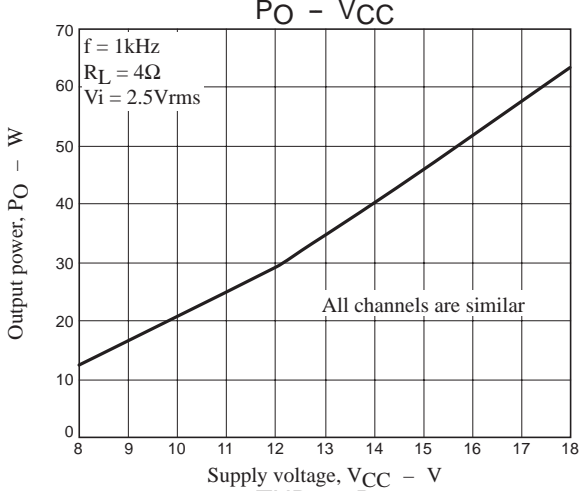
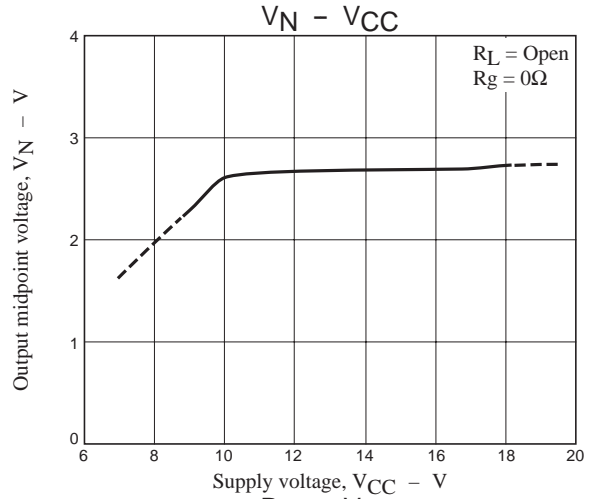
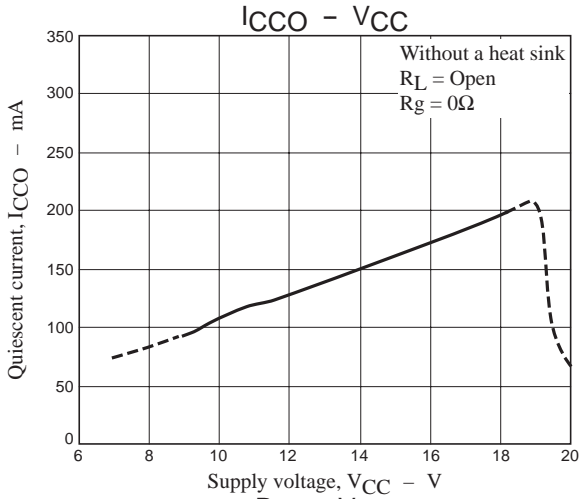

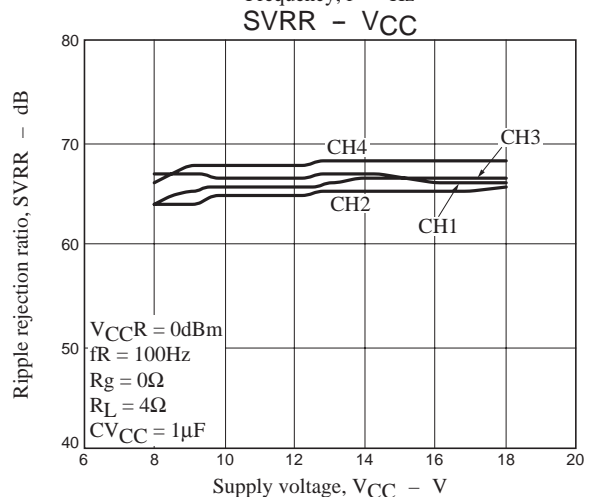
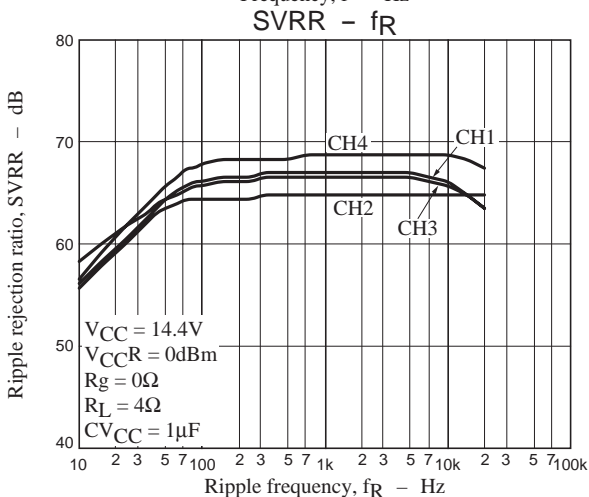
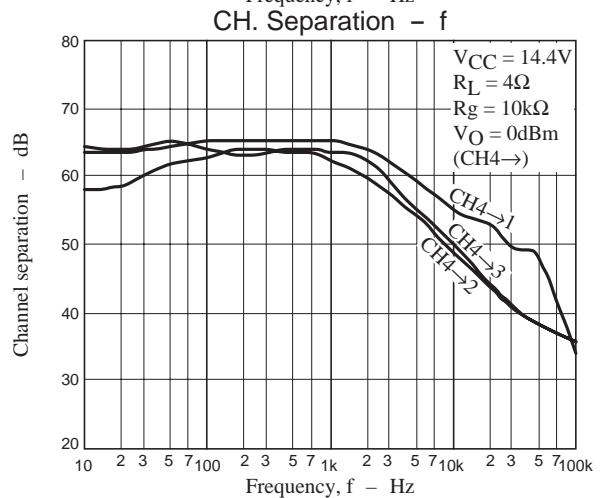
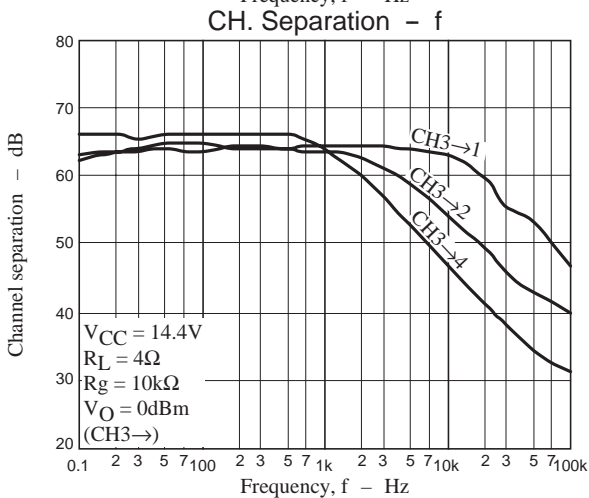
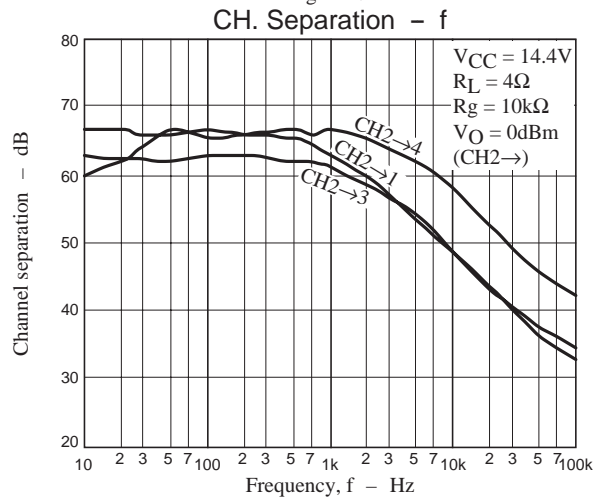
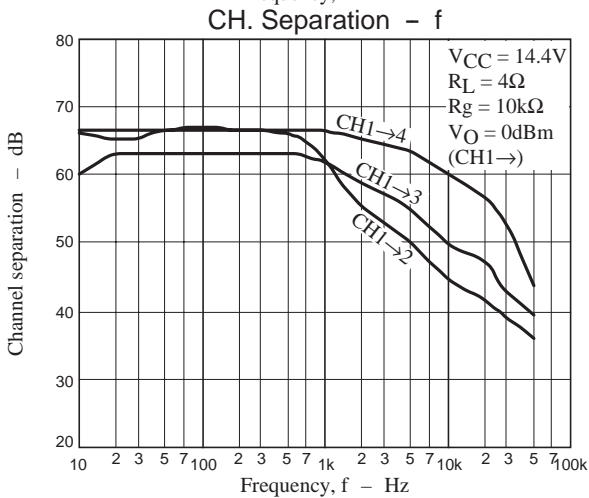
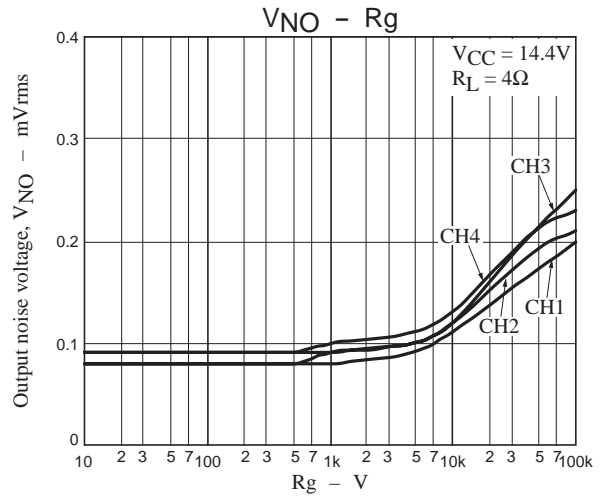
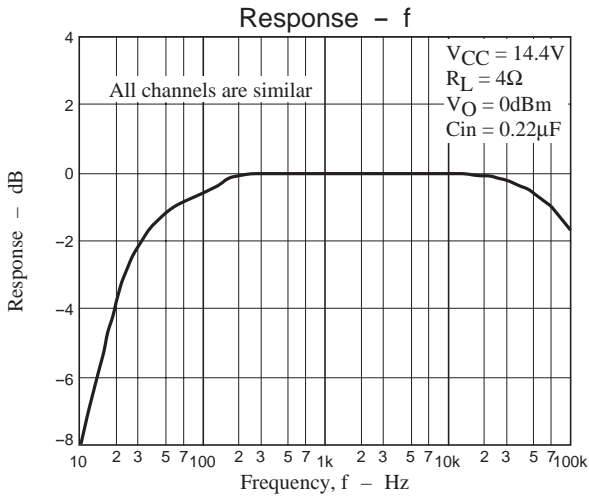

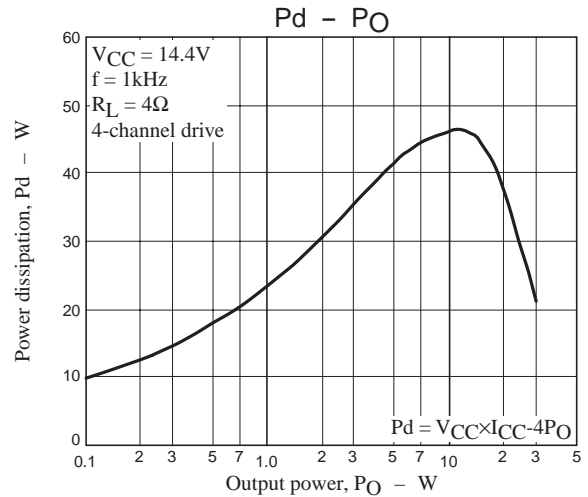
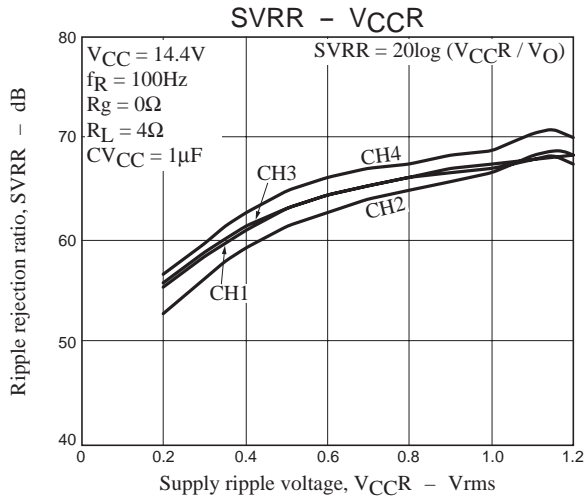

- Specifications of any and all SANYO Semiconductor products described or contained herein stipulate the performance, characteristics, and functions of the described products in the independent state, and are not guarantees of the performance, characteristics, and functions of the described products as mounted in the customer's products or equipment. To verify symptoms and states that cannot be evaluated in an independent device, the customer should always evaluate and test devices mounted in the customer's products or equipment.
- SANYO Semiconductor Co., Ltd. strives to supply high-quality high-reliability products. However, any and all semiconductor products fail with some probability. It is possible that these probabilistic failures could give rise to accidents or events that could endanger human lives, that could give rise to smoke or fire, or that could cause damage to other property. When designing equipment, adopt safety measures so that these kinds of accidents or events cannot occur. Such measures include but are not limited to protective circuits and error prevention circuits for safe design, redundant design, and structural design.
- In the event that any or all SANYO Semiconductor products (including technical data, services) described or contained herein are controlled under any of applicable local export control laws and regulations, such products must not be exported without obtaining the export license from the authorities concerned in accordance with the above law.
- No part of this publication may be reproduced or transmitted in any form or by any means, electronic or mechanical, including photocopying and recording, or any information storage or retrieval system, or otherwise, without the prior written permission of SANYO Semiconductor Co., Ltd.
- Any and all information described or contained herein are subject to change without notice due to product/technology improvement, etc. When designing equipment, refer to the "Delivery Specification" for the SANYO Semiconductor product that you intend to use.
- Information (including circuit diagrams and circuit parameters) herein is for example only; it is not guaranteed for volume production. SANYO Semiconductor believes information herein is accurate and reliable, but no guarantees are made or implied regarding its use or any infringements of intellectual property rights or other rights of third parties.

This catalog provides information as of November, 2006. Specifications and information herein are subject to change without notice.