

K9GAG08X0D
K9LBG08U1D
K9HCG08U5D

勝特力材料 886-3-5753170
勝特力电子(上海) 86-21-34970699
勝特力电子(深圳) 86-755-83298787
[Http://www.100y.com.tw](http://www.100y.com.tw)

INFORMATION IN THIS DOCUMENT IS PROVIDED IN RELATION TO SAMSUNG PRODUCTS, AND IS SUBJECT TO CHANGE WITHOUT NOTICE.

NOTHING IN THIS DOCUMENT SHALL BE CONSTRUED AS GRANTING ANY LICENSE, EXPRESS OR IMPLIED, BY ESTOPPEL OR OTHERWISE,

TO ANY INTELLECTUAL PROPERTY RIGHTS IN SAMSUNG PRODUCTS OR TECHNOLOGY. ALL INFORMATION IN THIS DOCUMENT IS PROVIDED

ON AS "AS IS" BASIS WITHOUT GUARANTEE OR WARRANTY OF ANY KIND.

1. For updates or additional information about Samsung products, contact your nearest Samsung office.
2. Samsung products are not intended for use in life support, critical care, medical, safety equipment, or similar applications where Product failure could result in loss of life or personal or physical harm, or any military or defense application, or any governmental procurement to which special terms or provisions may apply.

* Samsung Electronics reserves the right to change products or specification without notice.

Document Title

2G x 8 Bit/ 4G x 8 Bit/ 8G x 8 Bit NAND Flash Memory

Revision History

<u>Revision No</u>	<u>History</u>	<u>Draft Date</u>	<u>Remark</u>
0.0	1. Initial issue	Feb. 26th 2008	Advance
0.1	1. LGA package is added.	Mar. 14th 2008	Advance
0.2	1. K9HCG08U5D-L's package thickness is changed. 2. \overline{CE} and R/\overline{B} pin location of K9HCG08U5D-L is changed.	Oct. 16th 2008	Preliminary
1.0	tCBSY is changed.(3ms->4ms)	Jan. 21st 2009	Final

The attached data sheets are prepared and approved by SAMSUNG Electronics. SAMSUNG Electronics CO., LTD. reserve the right to change the specifications. SAMSUNG Electronics will evaluate and reply to your requests and questions about device. If you have any questions, please contact the SAMSUNG branch office near your office.

2G x 8 Bit/ 4G x 8 Bit/ 8G x 8 Bit NAND Flash Memory

PRODUCT LIST

Part Number	Vcc Range	Organization	PKG Type
K9GAG08B0D-P	2.5V ~ 2.9V	x8	TSOP1
K9GAG08U0D-P	2.7V ~ 3.6V		52ULGA
K9GAG08U0D-I			52ULGA(14x18)
K9LBG08U1D-I			52WLGA(14x18)
K9LBG08U1D-L			
K9HCG08U5D-L			

FEATURES

- Voltage Supply
 - 2.7V Device(K9G8G08B0D) : 2.5V ~ 2.9V
 - 3.3V Device(K9GAG08U0D) : 2.7V ~ 3.6V
- Organization
 - Memory Cell Array : (2G + 109M) x 8bit
 - Data Register : (4K + 218) x 8bit
- Automatic Program and Erase
 - Page Program : (4K + 218)Byte
 - Block Erase : (512K + 27.25K)Byte
- Page Read Operation
 - Page Size : (4K + 218)Byte
 - Random Read : 60µs(Max.)
 - Serial Access : 30ns(Min.)
- Memory Cell : 2bit / Memory Cell
- Fast Write Cycle Time
 - Program time : 800µs(Typ.)
 - Block Erase Time : 1.5ms(Typ.)
- Command/Address/Data Multiplexed I/O Port
- Hardware Data Protection
 - Program/Erase Lockout During Power Transitions
- Reliable CMOS Floating-Gate Technology
 - Endurance : TBD Cycles(with TBD ECC)
 - Data Retention : TBD Years
- Command Register Operation
- Unique ID for Copyright Protection
- Package :
 - K9GAG08U0D-PCB0/PIB0 : Pb-FREE PACKAGE
 - 48 - Pin TSOP I (12 x 20 / 0.5 mm pitch)
 - K9GAG08U0D-ICB0/IIB0
 - 52 - Pin ULGA (12 x 17 / 1.00 mm pitch)
 - K9LBG08U1D-ICB0/IIB0
 - 52 - Pin ULGA (12 x 17 / 1.00 mm pitch)
 - K9LBG08U1D-LCB0/LIB0 : Pb/Halogen-FREE PACKAGE
 - 52 - Pin ULGA (14 x 18 / 1.00 mm pitch)
 - K9HCG08U5D-LCB0/LIB0 : Pb/Halogen-FREE PACKAGE
 - 52 - Pin WLGA (14 x 18 / 1.00 mm pitch)

GENERAL DESCRIPTION

Offered in 2Gx8bit, the K9GAG08X0D is a 16G-bit NAND Flash Memory with spare 872M-bit. The device is offered in 2.7V and 3.3V Vcc. Its NAND cell provides the most cost-effective solution for the solid state mass storage market. A program operation can be performed in typical 800µs on the 4,314-byte page and an erase operation can be performed in typical 1.5ms on a (512K+27.25K)byte block. Data in the data register can be read out at 30ns cycle time per byte. The I/O pins serve as the ports for address and data input/output as well as command input. The on-chip write controller automates all program and erase functions including pulse repetition, where required, and internal verification and margining of data. Even the write-intensive systems can take advantage of the K9GAG08X0D's extended reliability of TBD cycles by providing ECC(Error Correcting Code) with real time mapping-out algorithm. The K9GAG08X0D is an optimum solution for large nonvolatile storage applications such as solid state file storage and other portable applications requiring non-volatility.

PIN CONFIGURATION (TSOP1)

K9GAG08X0D-PCB0/PIB0

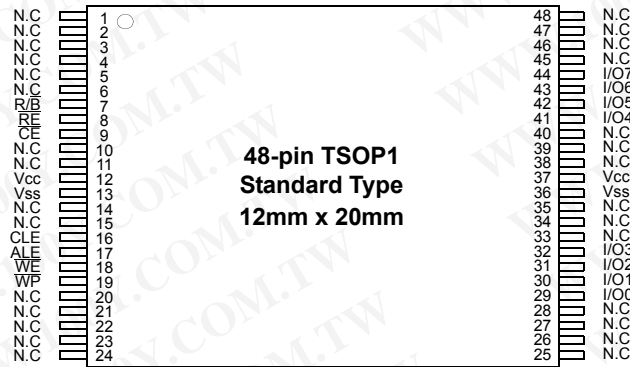

PACKAGE DIMENSIONS

48-PIN LEAD FREE PLASTIC THIN SMALL OUT-LINE PACKAGE TYPE(I)

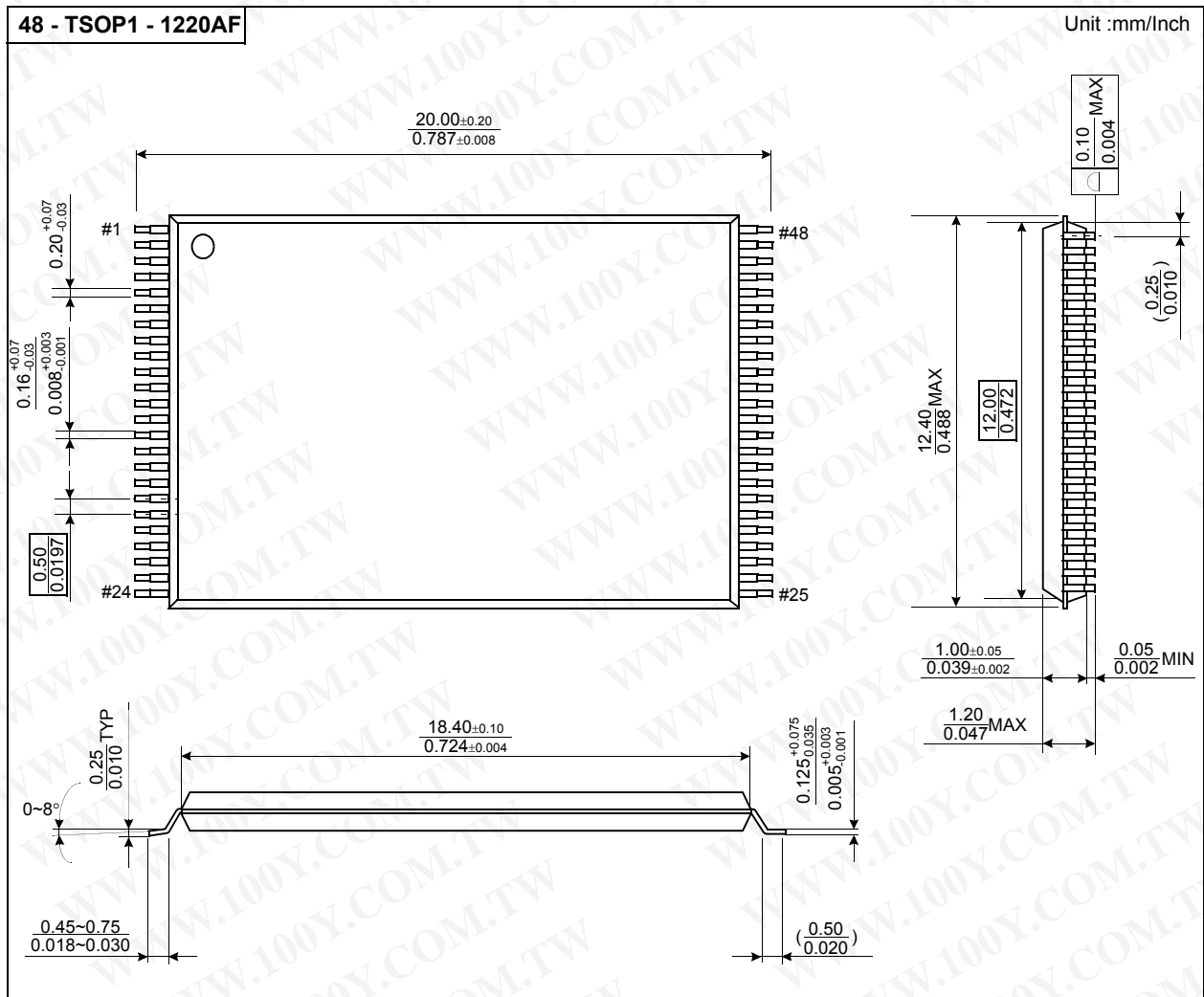

PIN CONFIGURATION (ULGA)

K9GAG08U0D-ICB0/IB0

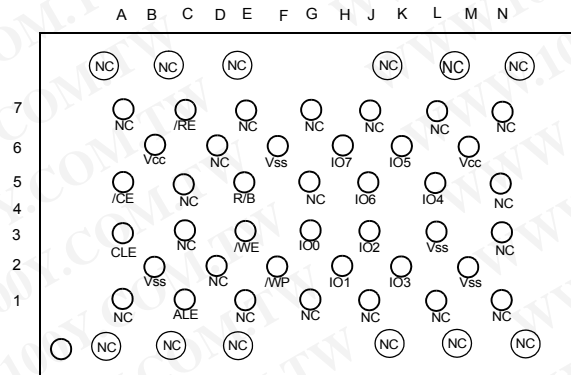

PACKAGE DIMENSIONS

52-ULGA (measured in millimeters)

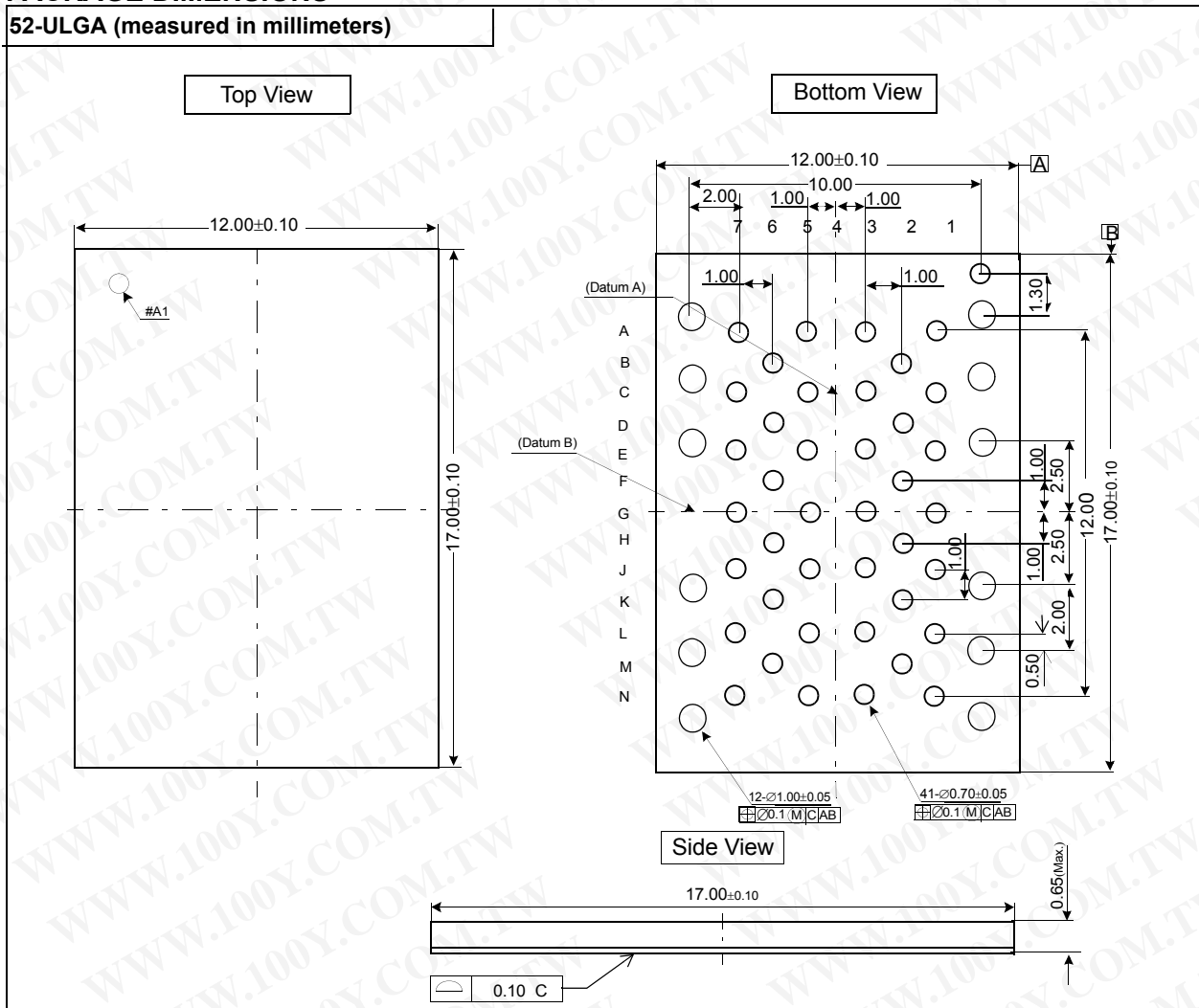

K9LBG08U1D-LCB0/LIB0

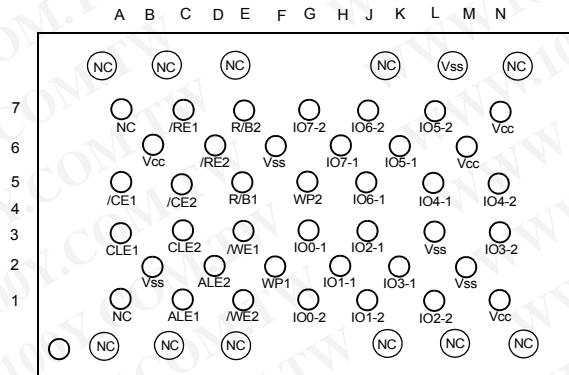

PACKAGE DIMENSIONS

52-ULGA (measured in millimeters)

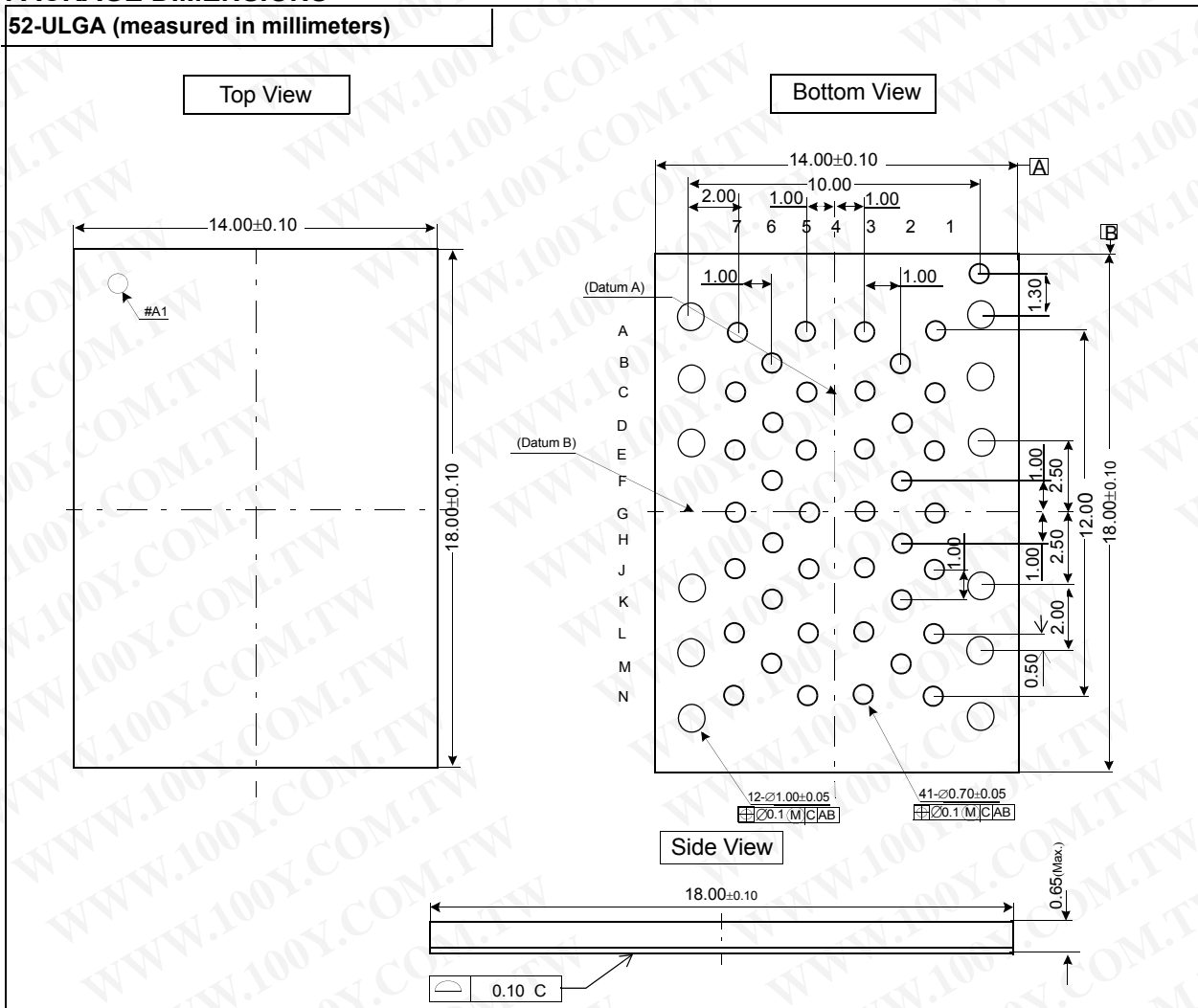

K9HCG08U5D-LCB0/LIB0

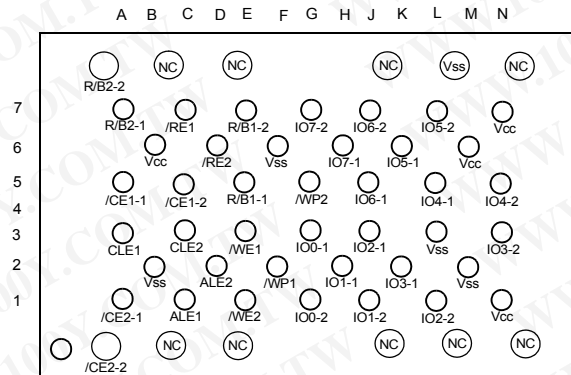

PACKAGE DIMENSIONS

52-WLGA (measured in millimeters)

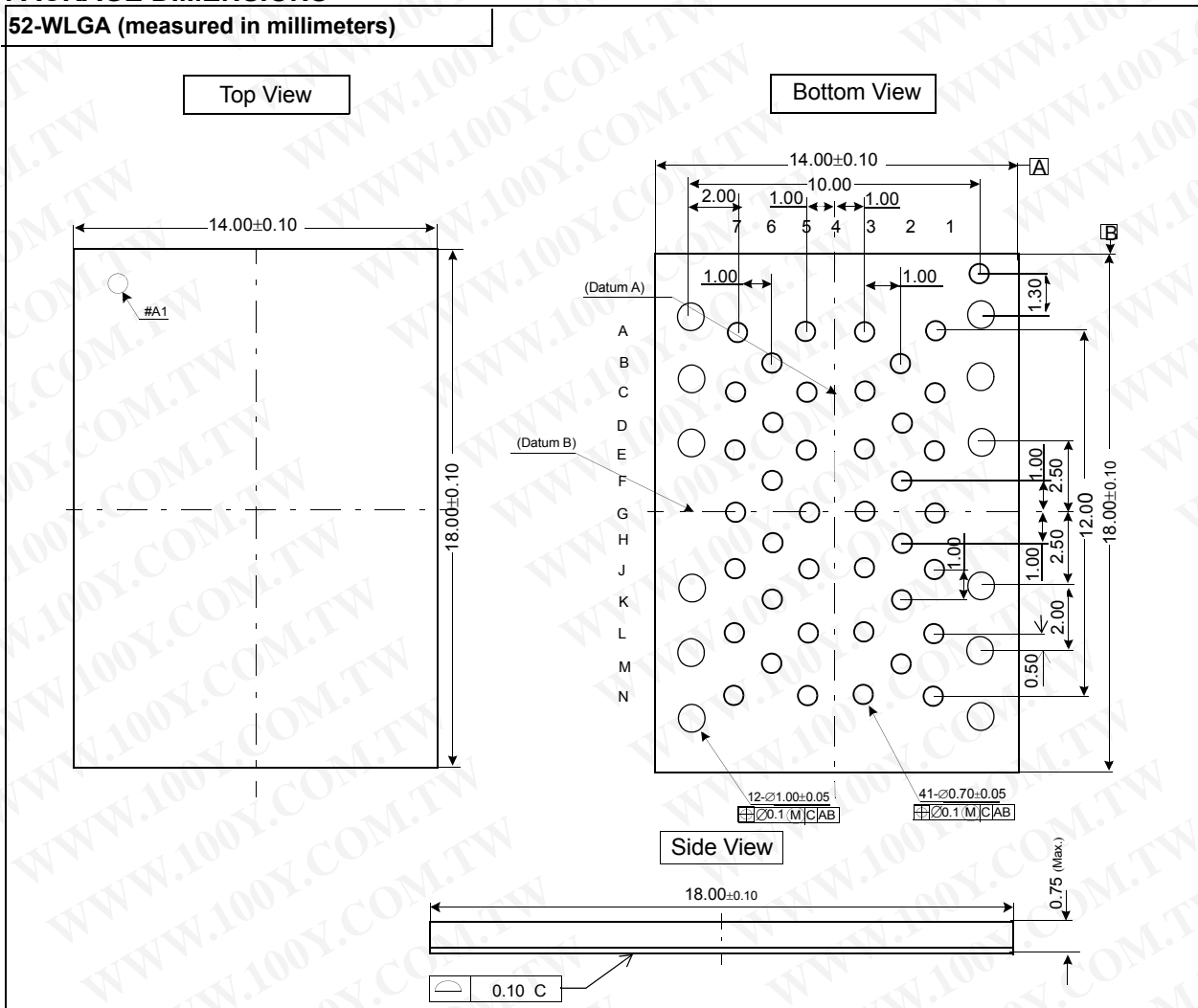

PIN DESCRIPTION

Pin Name	Pin Function
I/O ₀ ~ I/O ₇	DATA INPUTS/OUTPUTS The I/O pins are used to input command, address and data, and to output data during read operations. The I/O pins float to high-z when the chip is deselected or when the outputs are disabled.
CLE	COMMAND LATCH ENABLE The CLE input controls the activating path for commands sent to the command register. When active high, commands are latched into the command register through the I/O ports on the rising edge of the WE signal.
ALE	ADDRESS LATCH ENABLE The ALE input controls the activating path for address to the internal address registers. Addresses are latched on the rising edge of WE with ALE high.
$\overline{\text{CE}}$	CHIP ENABLE The CE input is the device selection control. When the device is in the Busy state, CE high is ignored, and the device does not return to standby mode in program or erase operation.
$\overline{\text{RE}}$	READ ENABLE The RE input is the serial data-out control, and when active drives the data onto the I/O bus. Data is valid tREA after the falling edge of RE which also increments the internal column address counter by one.
$\overline{\text{WE}}$	WRITE ENABLE The WE input controls writes to the I/O port. Commands, address and data are latched on the rising edge of the WE pulse.
$\overline{\text{WP}}$	WRITE PROTECT The WP pin provides inadvertent program/erase protection during power transitions. The internal high voltage generator is reset when the WP pin is active low.
R/B	READY/BUSY OUTPUT The R/B output indicates the status of the device operation. When low, it indicates that a program, erase or random read operation is in process and returns to high state upon completion. It is an open drain output and does not float to high-z condition when the chip is deselected or when outputs are disabled.
Vcc	POWER Vcc is the power supply for device.
Vss	GROUND
N.C	NO CONNECTION Lead is not internally connected.

NOTE : Connect all Vcc and Vss pins of each device to common power supply outputs.
 Do not leave Vcc or Vss disconnected.

Figure 1. K9GAG08X0D Functional Block Diagram

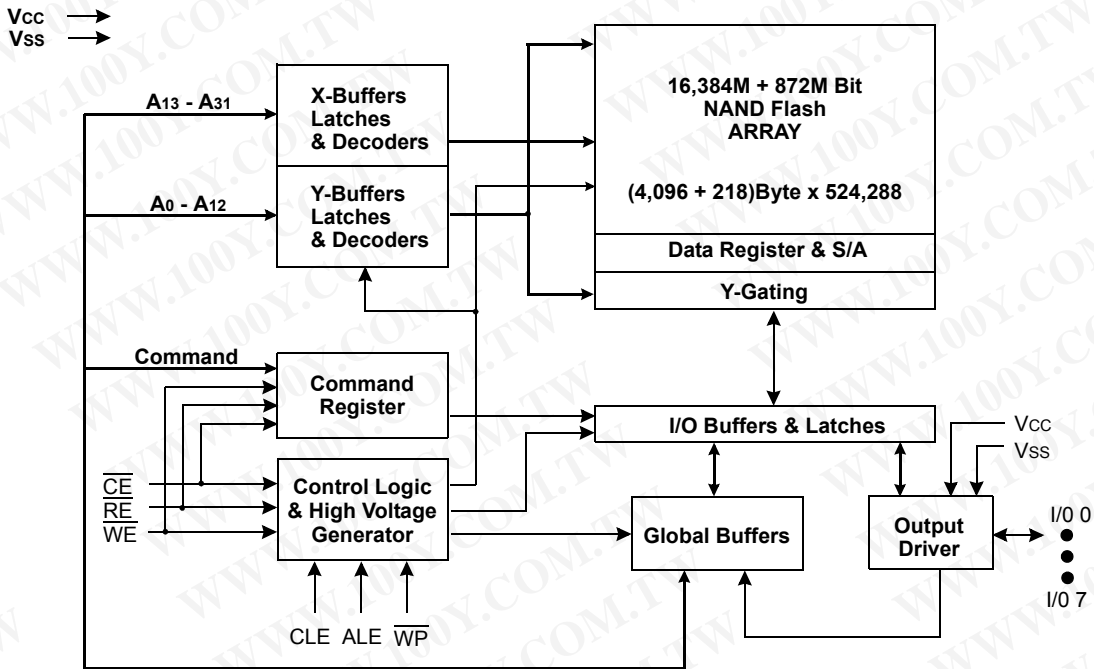
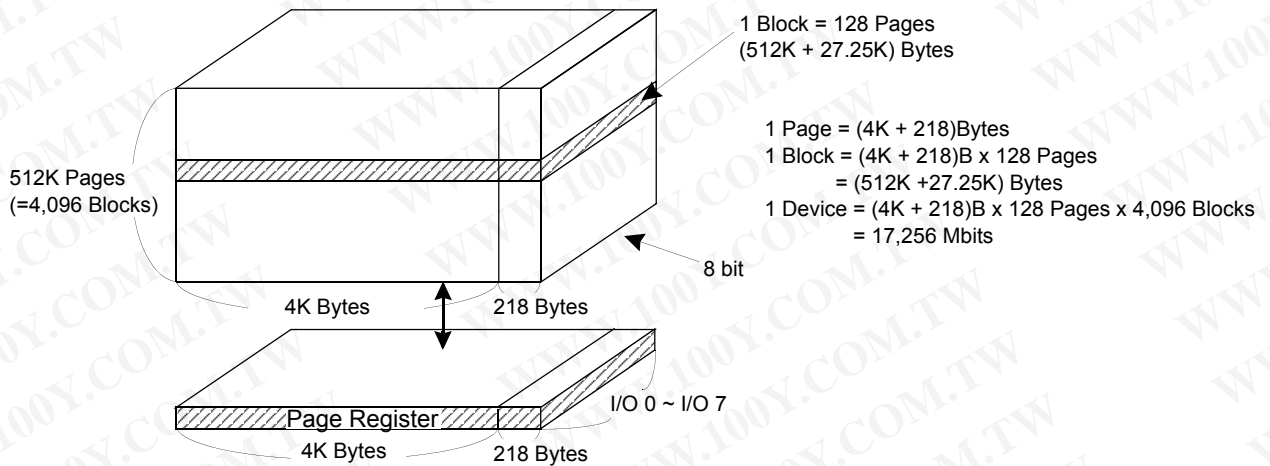

Figure 2. K9GAG08X0D Array Organization



	I/O 0	I/O 1	I/O 2	I/O 3	I/O 4	I/O 5	I/O 6	I/O 7
1st Cycle	A ₀	A ₁	A ₂	A ₃	A ₄	A ₅	A ₆	A ₇
2nd Cycle	A ₈	A ₉	A ₁₀	A ₁₁	A ₁₂	*L	*L	*L
3rd Cycle	A ₁₃	A ₁₄	A ₁₅	A ₁₆	A ₁₇	A ₁₈	A ₁₉	A ₂₀
4th Cycle	A ₂₁	A ₂₂	A ₂₃	A ₂₄	A ₂₅	A ₂₆	A ₂₇	A ₂₈
5th Cycle	A ₂₉	A ₃₀	A ₃₁	*L	*L	*L	*L	*L

Column Address

Row Address;

Page Address : A₁₃ ~ A₁₉

Plane Address : A₂₀

Block Address : A₂₁ ~ the last Address

NOTE : Column Address : Starting Address of the Register.

* L must be set to 'Low'.

* The device ignores any additional input of address cycles than required.

* Row Address consists of Page address (A₁₃ ~ A₁₉) & Plane address(A₂₀) & Block address(A₂₁ ~ the last Address)

Product Introduction

NAND Flash Memory has addresses multiplexed into 8 I/Os. This scheme dramatically reduces pin counts and allows system upgrades to future densities by maintaining consistency in system board design. Command, address and data are all written through I/O's by bringing WE to low while CE is low. Those are latched on the rising edge of WE. Command Latch Enable(CLE) and Address Latch Enable(ALE) are used to multiplex command and address respectively, via the I/O pins. Some commands require one bus cycle. For example, Reset Command, Status Read Command, etc. require just one cycle bus. Some other commands, like page read and block erase and page program, require two cycles: one cycle for setup and the other cycle for execution. Page Read and Page Program need the same five address cycles following the required command input. In Block Erase operation, however, only the three row address cycles are used. Device operations are selected by writing specific commands into the command register. Table 1 defines the specific commands of the K9GAG08X0D.

Table 1. Command Sets

Function	1st Set	2nd Set	
Read	00h	30h	
Read for Copy Back	00h	35h	
Cache Read	31h	-	
Read Start for Last Page Cache Read	3Fh	-	
Page Program	80h	10h	
Cache Program	80h	15h	
Copy-Back Program	85h	10h	
Block Erase	60h	D0h	
Random Data Input ⁽¹⁾	85h	-	
Random Data Output ⁽¹⁾	05h	E0h	
Two-Plane Read ⁽³⁾	60h----60h	30h	
Two-Plane Read for Copy-Back ⁽³⁾	60h----60h	35h	
Two-Plane Random Data Output ⁽¹⁾⁽³⁾	00h----05h	E0h	
Two-Plane Cache Read ⁽³⁾	60h----60h	33h	
Two-Plane Page Program ⁽²⁾	80h----11h	81h----10h	
Two-Plane Copy-Back Program ⁽²⁾	85h----11h	81h----10h	
Two-Plane Cache Program ⁽²⁾	80h----11h	81h----15h	
Two-Plane Block Erase	60h----60h	D0h	
Read ID	90h	-	
Read Status	70h	-	O
Read Status 2	F1h	-	O
Reset	FFh	-	O

- NOTE :** 1. Random Data Input/Output can be executed in a page.
 2. Any command between 11h and 80h/81h/85h is prohibited except 70h/F1h and FFh.
 3. Two-Plane Random Data out must be used after Two-Plane Read or Two-Plane Cache Read operation

Caution : Any undefined command inputs are prohibited except for above command set of Table 1.

ABSOLUTE MAXIMUM RATINGS

Parameter		Symbol	Rating	Unit
Voltage on any pin relative to Vss		Vcc	-0.6 to + 4.6	V
		VIN	-0.6 to + 4.6	
		VIO	-0.6 to Vcc+0.3 (<4.6V)	
Temperature Under Bias	K9XXG08UXD-XCB0	TBIAS	-10 to +125	°C
	K9XXG08UXD-XIB0		-40 to +125	
Storage Temperature	K9XXG08UXD-XCB0	TSTG	-65 to +150	°C
	K9XXG08UXD-XIB0			
Short Circuit Current		Ios	5	mA

NOTE :

1. Minimum DC voltage is -0.6V on input/output pins. During transitions, this level may undershoot to -2.0V for periods <30ns.
 Maximum DC voltage on input/output pins is Vcc+0.3V which, during transitions, may overshoot to Vcc+2.0V for periods <20ns.
2. Permanent device damage may occur if ABSOLUTE MAXIMUM RATINGS are exceeded. Functional operation should be restricted to the conditions as detailed in the operational sections of this data sheet. Exposure to absolute maximum rating conditions for extended periods may affect reliability.

RECOMMENDED OPERATING CONDITIONS

(Voltage reference to GND, K9XXG08XXD-XCB0 :TA=0 to 70°C, K9XXG08XXD-XIB0:TA=-40 to 85°C)

Parameter	Symbol	2.7V			3.3V			Unit
		Min	Typ.	Max	Min	Typ.	Max	
Supply Voltage	Vcc	2.5	2.7	2.9	2.7	3.3	3.6	V
Supply Voltage	Vss	0	0	0	0	0	0	V

DC AND OPERATING CHARACTERISTICS (Recommended operating conditions otherwise noted.)

Parameter		Symbol	Test Conditions	2.7V			3.3V			Unit
				Min	Typ	Max	Min	Typ	Max	
Operating Current	Page Read with Serial Access	I _{CC1}	t _{RC} =30ns CE=V _{IL} , I _{OUT} =0mA	-	15	30	-	15	30	mA
	Program	I _{CC2}	-	-	-	-	-	-		
	Erase	I _{CC3}	-	-	-	-	-	-		
Stand-by Current(TTL)		ISB1	CE=V _{IH} , WP=0V/V _{CC}	-	-	1	-	-	1	
Stand-by Current(CMOS)		ISB2	CE=V _{CC} -0.2, WP=0V/V _{CC}	-	10	50	-	10	50	
Input Leakage Current		I _{LI}	V _{IN} =0 to V _{CC} (max)	-	-	±10	-	-	±10	µA
Output Leakage Current		I _{LO}	V _{OUT} =0 to V _{CC} (max)	-	-	±10	-	-	±10	
Input High Voltage		V _{IH} (¹)	-	0.8 xV _{CC}	-	V _{CC} +0.3	0.8 xV _{CC}	-	V _{CC} +0.3	V
Input Low Voltage, All inputs		V _{IL} (¹)	-	-0.3	-	0.2 xV _{CC}	-0.3	-	0.2 xV _{CC}	
Output High Voltage Level		V _{OH}	K9GAG08B0D :I _{OH} =-100µA K9GAG08U0D :I _{OH} =-400µA	V _{CC} -0.4	-	-	2.4	-	-	
Output Low Voltage Level		V _{OL}	K9GAG08B0D :I _{OL} =100µA K9GAG08U0D :I _{OL} =2.1mA	-	-	0.4	-	-	0.4	
Output Low Current(R/B)		I _{OL} (R/B)	K9GAG08B0D :V _{OL} =0.1V K9GAG08U0D :V _{OL} =0.4V	3	4	-	8	10	-	mA

- NOTE :** 1. V_{IL} can undershoot to -0.4V and V_{IH} can overshoot to V_{CC} +0.4V for durations of 20 ns or less.
2. Typical value is measured at V_{CC}=3.3V, T_A=25°C. Not 100% tested.
3. The typical value of the K9LBG08U1D's ISB2 is 20µA and the maximum value is 100µA.
4. The typical value of the K9HCG08U1D's ISB2 is 40µA and the maximum value is 200µA.
6. The maximum value of K9HCG08U5D-L's I_{LI} and I_{LO} is ±20µA.

VALID BLOCK

Parameter	Symbol	Min	Typ.	Max	Unit
K9GAG08U0D	NVB	3,996	-	4,096	Blocks
K9LBG08U1D		7,992	-	8,192	
K9HCG08U5D		15,984	-	16,384	

NOTE :

- The device may include initial invalid blocks when first shipped. Additional invalid blocks may develop while being used. The number of valid blocks is presented with both cases of invalid blocks considered. Invalid blocks are defined as blocks that contain one or more bad bits which cause status failure during program and erase operation. Do not erase or program factory-marked bad blocks. Refer to the attached technical notes for appropriate management of invalid blocks.
- The 1st block, which is placed on 00h block address, is guaranteed to be a valid block at the time of shipment
- The number of valid blocks is on the basis of single plane operations, and this may be decreased with two plane operations.

AC TEST CONDITION

(K9XXG08XXD-XCB0 :TA=0 to 70°C, K9XXG08XXD-XIB0:TA=-40 to 85°C,
 K9GAG08B0D: Vcc=2.5V ~ 2.9V, K9XXG08UXD: Vcc=2.7V ~ 3.3V,unless otherwise noted)

Parameter	K9G8G08B0D	K9XXG08UXD
Input Pulse Levels	0V to Vcc	0V to Vcc
Input Rise and Fall Times	5ns	5ns
Input and Output Timing Levels	Vcc/2	Vcc/2
Output Load	1 TTL GATE and CL=30pF	1 TTL GATE and CL=50pF

CAPACITANCE(TA=25°C, VCC=2.7V/3.3V, f=1.0MHz)

Item	Symbol	Test Condition	Min	Max	Unit
Input/Output Capacitance	C _{I/O}	V _{IL} =0V	-	8	pF
	C _{I/O(W)*}		-	5	pF
Input Capacitance	C _{IN}	V _{IN} =0V	-	8	pF
	C _{IN(W)*}		-	5	pF

NOTE : 1. Capacitance is periodically sampled and not 100% tested.
 2. C_{I/O(W)} and C_{IN(W)} are tested at wafer level.
 3. K9HCG08U5D-LXB0's capacitance(I/O, Input) is 13pF.

MODE SELECTION

CLE	ALE	CE	WE	RE	WP	Mode	
H	L	L		H	X	Read Mode	Command Input
L	H	L		H	X		Address Input(5clock)
H	L	L		H	H	Write Mode	Command Input
L	H	L		H	H		Address Input(5clock)
L	L	L		H	H	Data Input	
L	L	L	H		X	Data Output	
X	X	X	X	H	X	During Read(Busy)	
X	X	X	X	X	H	During Program(Busy)	
X	X	X	X	X	H	During Erase(Busy)	
X	X ⁽¹⁾	X	X	X	L	Write Protect	
X	X	H	X	X	0V/Vcc ⁽²⁾	Stand-by	

NOTE : 1. X can be V_{IL} or V_{IH}.
 2. WP should be biased to CMOS high or CMOS low for standby.

Program / Erase Characteristics

Parameter	Symbol	Min	Typ	Max	Unit
Program Time	t _{PROG}	-	0.8	3	ms
Dummy Busy Time for Two-Plane Program	t _{DBSY}	-	0.5	1	μs
Dummy Busy Time for Cache Program	t _{CBSY} ⁽⁴⁾	-	-	4	ms
Number of Partial Program Cycles in the Same Page	Nop	-	-	1	cycle
Block Erase Time	t _{BERS}	-	1.5	10	ms

NOTE : 1. Typical program time is measured at Vcc=3.3V, TA=25°C. Not 100% tested.
 2. Typical Program time is defined as the time within which more than 50% of the whole pages are programmed at 3.3V Vcc and 25°C temperature.
 3. Within a same block, program time(t_{PROG}) of page group A is faster than that of page group B. Typical t_{PROG} is the average program time of the page group A and B(Table 5).
 Page Group A: Page 0, 1, 2, 3, 6, 7, 10, 11, ... , 110, 111, 114, 115, 118, 119, 122, 123
 Page Group B: Page 4, 5, 8, 9, 12, 13, 16, 17, ... , 116, 117, 120, 121, 124, 125, 126, 127
 4. t_{CBSY} depends on the timing between internal programming time and data in time.

AC Timing Characteristics for Command / Address / Data Input

Parameter	Symbol	Min	Max	Unit
CLE Setup Time	tCLS ⁽¹⁾	15	-	ns
CLE Hold Time	tCLH	5	-	ns
$\overline{\text{CE}}$ Setup Time	tCS ⁽¹⁾	20	-	ns
$\overline{\text{CE}}$ Hold Time	tCH	5	-	ns
$\overline{\text{WE}}$ Pulse Width	tWP	15	-	ns
ALE Setup Time	tALS ⁽¹⁾	15	-	ns
ALE Hold Time	tALH	5	-	ns
Data Setup Time	tDS ⁽¹⁾	15	-	ns
Data Hold Time	tDH	5	-	ns
Write Cycle Time	tWC	30	-	ns
$\overline{\text{WE}}$ High Hold Time	tWH	10	-	ns
Address to Data Loading Time	tADL ⁽²⁾	100	-	ns

NOTES : 1. The transition of the corresponding control pins must occur only once while $\overline{\text{WE}}$ is held low
2. tADL is the time from the $\overline{\text{WE}}$ rising edge of final address cycle to the $\overline{\text{WE}}$ rising edge of first data cycle

AC Characteristics for Operation

Parameter	Symbol	Min	Max	Unit
Data Transfer from Cell to Register	tR	-	60	μs
ALE to $\overline{\text{RE}}$ Delay	tAR	10	-	ns
CLE to $\overline{\text{RE}}$ Delay	tCLR	10	-	ns
Ready to $\overline{\text{RE}}$ Low	tRR	20	-	ns
$\overline{\text{RE}}$ Pulse Width	tRP	15	-	ns
$\overline{\text{WE}}$ High to Busy	tWB	-	100	ns
$\overline{\text{WP}}$ High to $\overline{\text{WE}}$ Low	tWW	100	-	ns
Read Cycle Time	tRC	30	-	ns
$\overline{\text{RE}}$ Access Time	tREA	-	20	ns
$\overline{\text{CE}}$ Access Time	tCEA	-	25	ns
$\overline{\text{RE}}$ High to Output Hi-Z	tRHZ	-	100	ns
$\overline{\text{CE}}$ High to Output Hi-Z	tCHZ	-	30	ns
$\overline{\text{CE}}$ High to ALE or CLE Don't Care	tCSD	0	-	ns
$\overline{\text{RE}}$ High to Output Hold	tRHOH	15	-	ns
$\overline{\text{RE}}$ Low to Output Hold	tRLOH	5	-	ns
$\overline{\text{RE}}$ High Hold Time	tREH	10	-	ns
Output Hi-Z to $\overline{\text{RE}}$ Low	tIR	0	-	ns
$\overline{\text{RE}}$ High to $\overline{\text{WE}}$ Low	tRHW	100	-	ns
$\overline{\text{WE}}$ High to $\overline{\text{RE}}$ Low	tWHR	60	-	ns
Device Resetting Time(Read/Program/Erase)	tRST	-	5/10/500 ⁽¹⁾	μs
Cache Busy in Read Cache (following 31h and 3Fh)	tDCBSYR	-	65	μs

NOTE: 1. If reset command(FFh) is written at Ready state, the device goes into Busy for maximum 5 μs .

NAND Flash Technical Notes

Initial Invalid Block(s)

Initial invalid blocks are defined as blocks that contain one or more initial invalid bits whose reliability is not guaranteed by Samsung. The information regarding the initial invalid block(s) is called the initial invalid block information. Devices with initial invalid block(s) have the same quality level as devices with all valid blocks and have the same AC and DC characteristics. An initial invalid block(s) does not affect the performance of valid block(s) because it is isolated from the bit line and the common source line by a select transistor. The system design must be able to mask out the initial invalid block(s) via address mapping. The 1st block, which is placed on 00h block address, is guaranteed to be a valid block at the time of shipment.

Identifying Initial Invalid Block(s)

All device locations are erased(FFh) except locations where the initial invalid block(s) information is written prior to shipping. The initial invalid block(s) status is defined by the 1st byte in the spare area. Samsung makes sure that the last page of every initial invalid block has non-FFh data at the column address of 4,096. The initial invalid block information is also erasable in most cases, and it is impossible to recover the information once it has been erased. Therefore, the system must be able to recognize the initial invalid block(s) based on the initial invalid block information and create the initial invalid block table via the following suggested flow chart(Figure 3). Any intentional erasure of the initial invalid block information is prohibited.

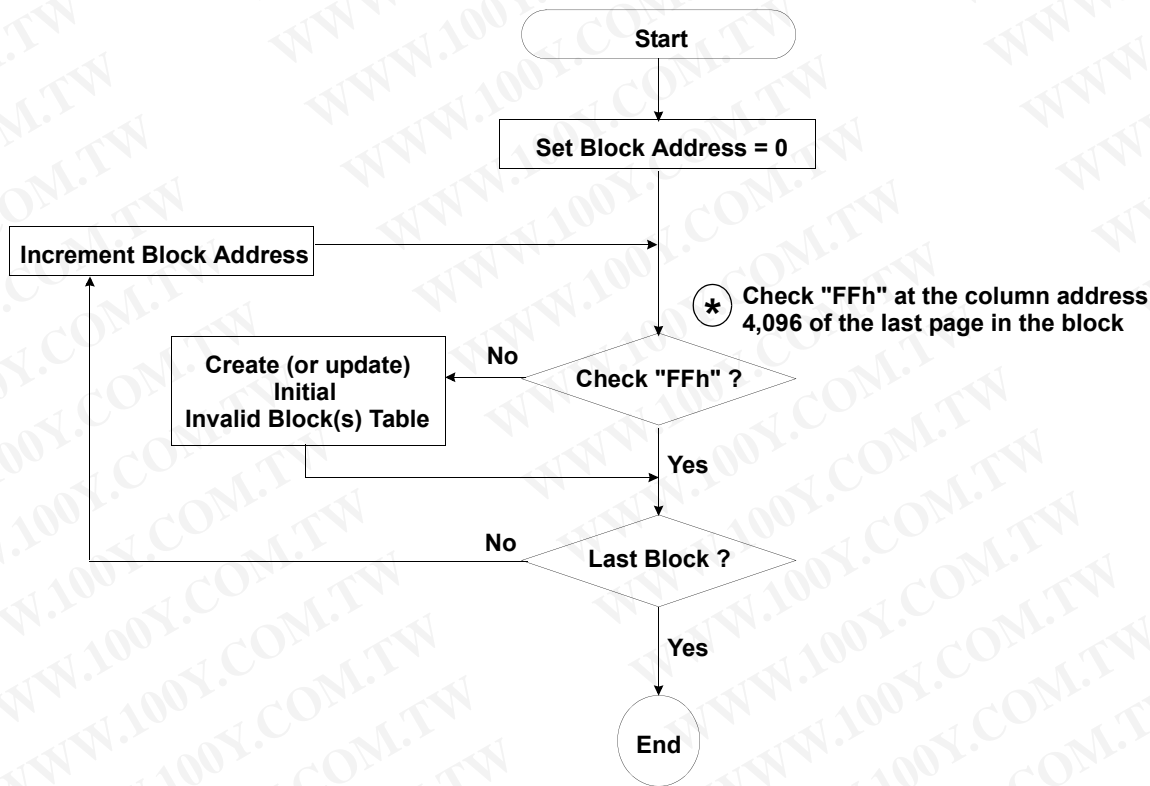

Figure 3. Flow chart to create initial invalid block table.

Error in write or read operation

Within its life time, additional invalid blocks may develop with NAND Flash memory. Refer to the qualification report for the actual data. Block replacement should be done upon erase or program error.

	Failure Mode	Detection and Countermeasure sequence
Write	Erase Failure	Status Read after Erase --> Block Replacement
	Program Failure	Status Read after Program --> Block Replacement
Read	Up to Eight Bit Failure	Verify ECC -> ECC Correction

ECC : Error Correcting Code --> RS Code or BCH Code etc.
 Example) 8bit correction / 512-byte

Program Flow Chart

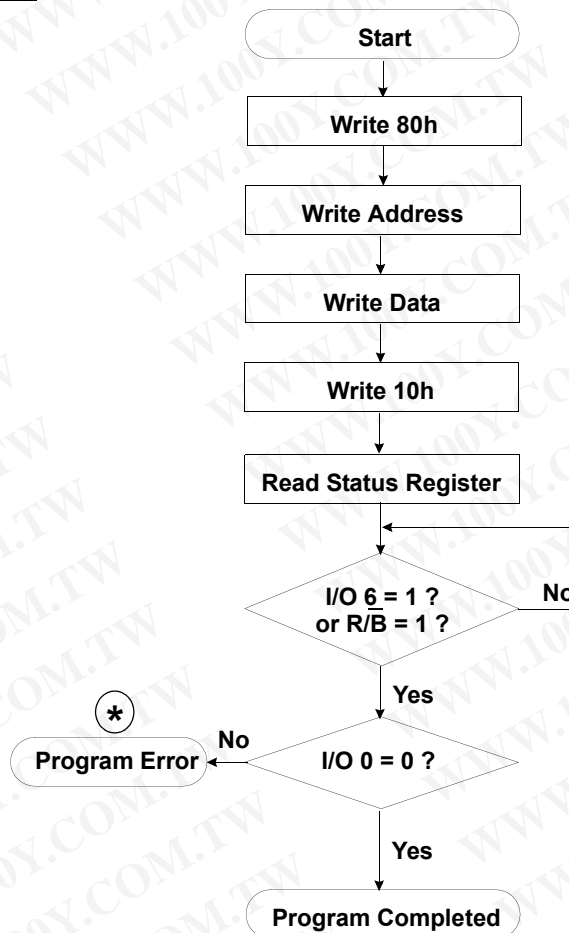

***** : If program operation results in an error, map out the block including the page in error and copy the target data to another block.

NAND Flash Technical Notes (Continued)

Erase Flow Chart

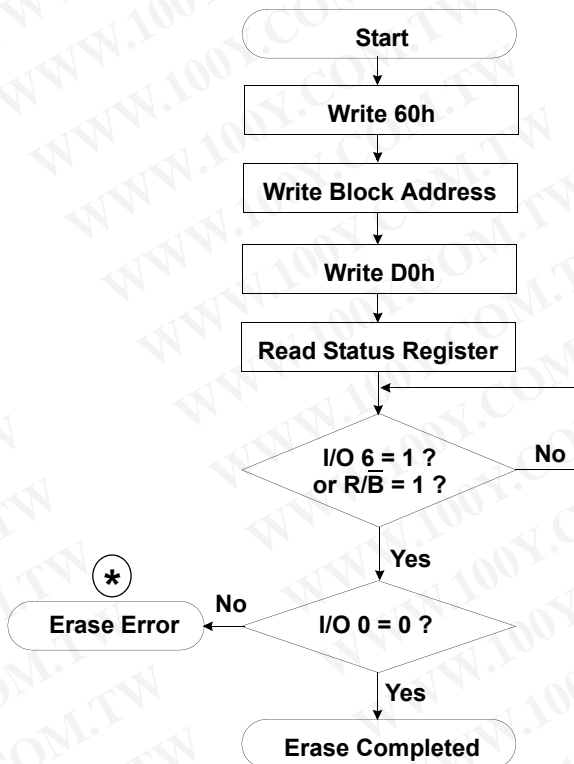

Read Flow Chart

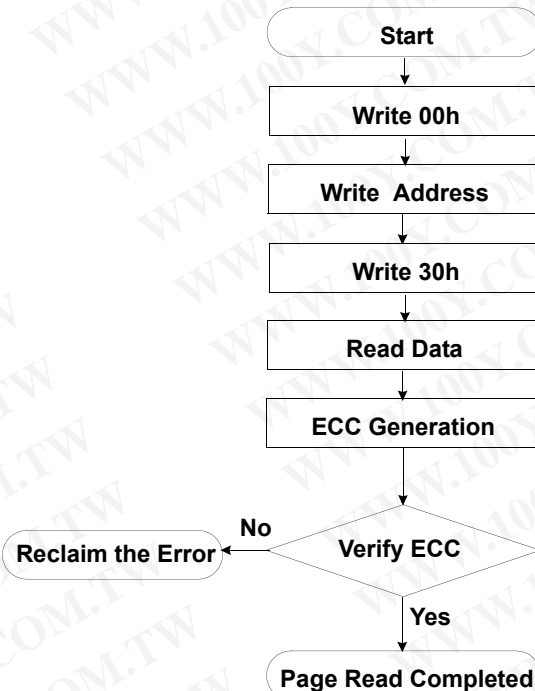

* : If erase operation results in an error, map out the failing block and replace it with another block.

Block Replacement

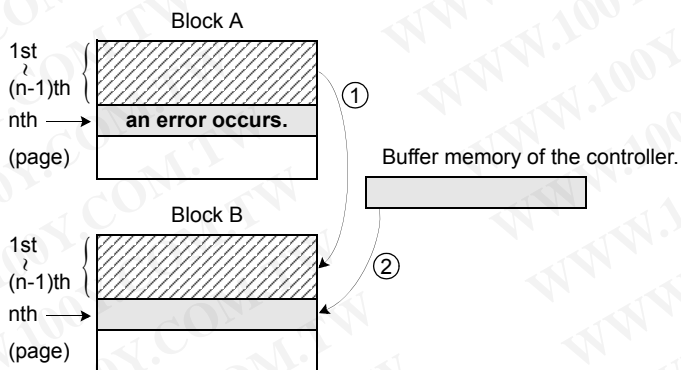

- * Step1
When an error happens in the nth page of the Block 'A' during erase or program operation.
- * Step2
Copy the data in the 1st ~ (n-1)th page to the same location of another free block. (Block 'B')
- * Step3
Then, copy the nth page data of the Block 'A' in the buffer memory to the nth page of the Block 'B'.
- * Step4
Do not erase or program Block 'A' by creating an 'invalid block' table or other appropriate scheme.

Addressing for program operation

Within a block, the pages must be programmed consecutively from the LSB (least significant bit) page of the block to MSB (most significant bit) pages of the block. Random page address programming is prohibited. In this case, the definition of LSB page is the LSB among the pages to be programmed. Therefore, LSB doesn't need to be page 0.

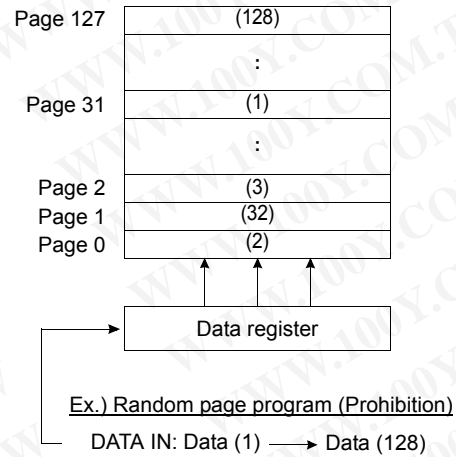
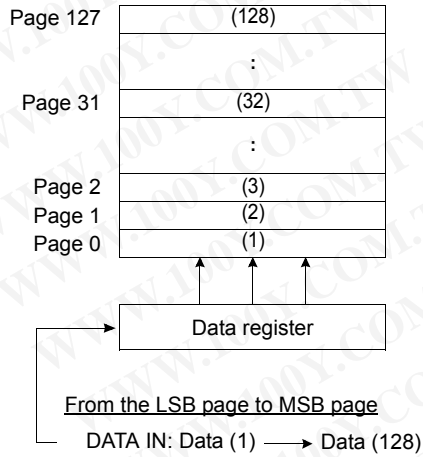

System Interface Using \overline{CE} don't-care.

For an easier system interface, \overline{CE} may be inactive during the data-loading or serial access as shown below. The internal 4,314byte data registers are utilized as separate buffers for this operation and the system design gets more flexible. In addition, for voice or audio applications which use slow cycle time on the order of μ -seconds, de-activating \overline{CE} during the data-loading and serial access would provide significant savings in power consumption.

Figure 4. Program Operation with \overline{CE} don't-care.

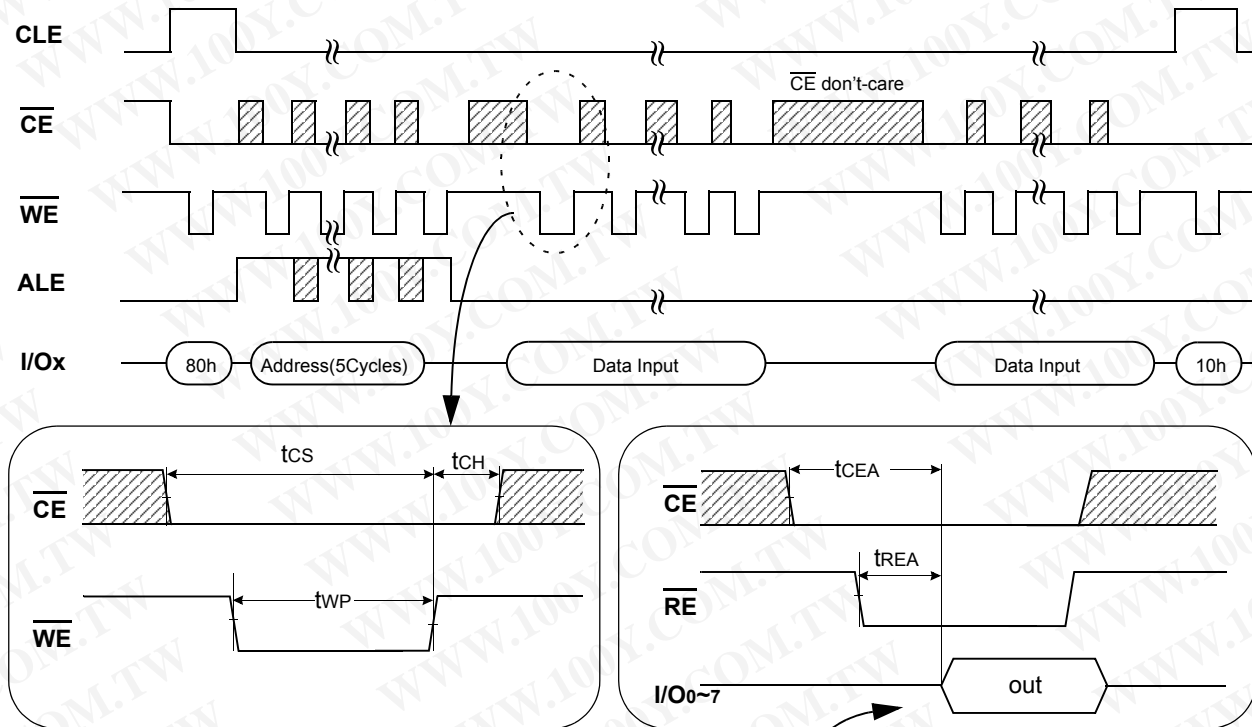
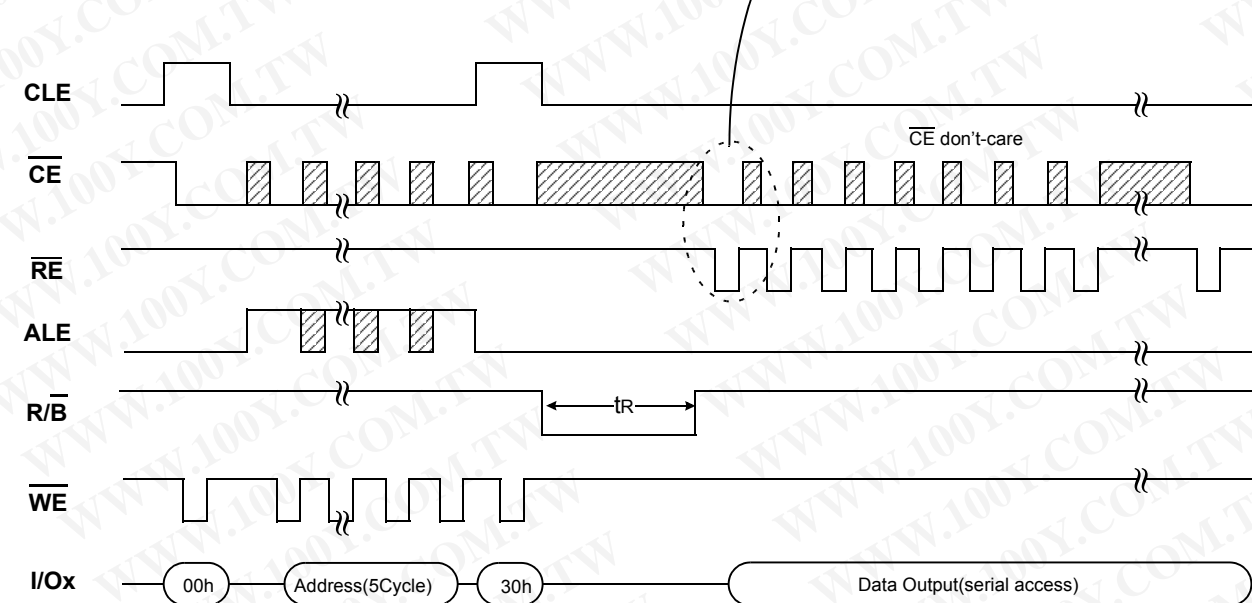

Figure 5. Read Operation with \overline{CE} don't-care.



NOTE

Device	I/O	DATA	ADDRESS				
	I/Ox	Data In/Out	Col. Add1	Col. Add2	Row Add1	Row Add2	Row Add3
K9GAG08X0D	I/O 0 ~ I/O 7	4,314byte	A0~A7	A8~A12	A13~A20	A21~A28	A29~A31

Command Latch Cycle

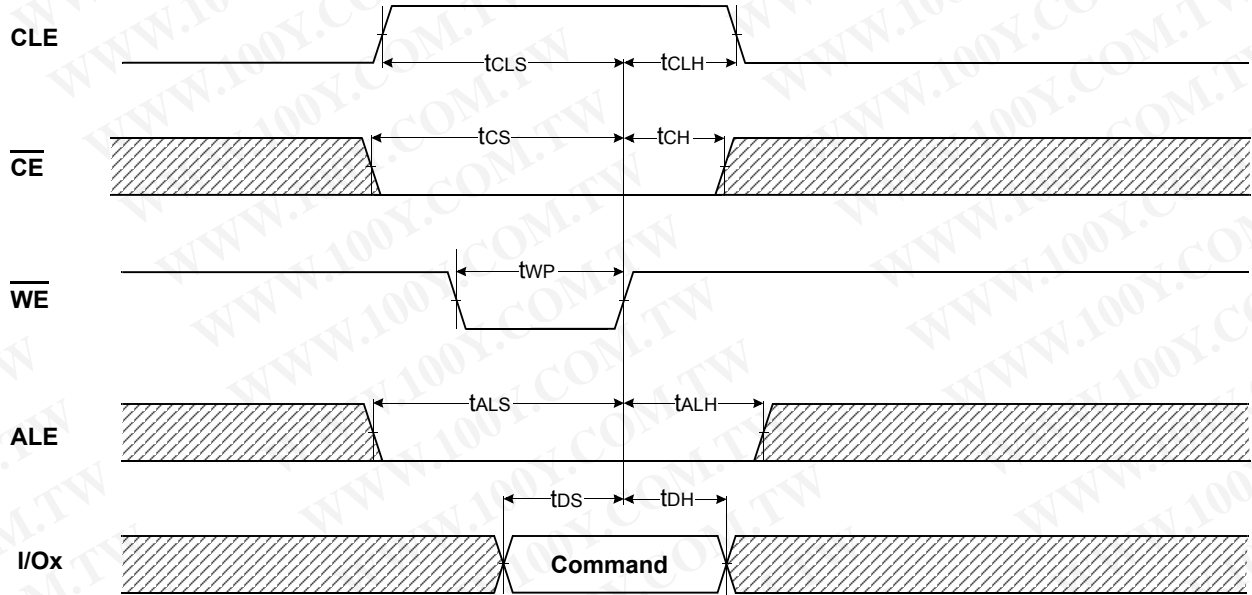

Address Latch Cycle

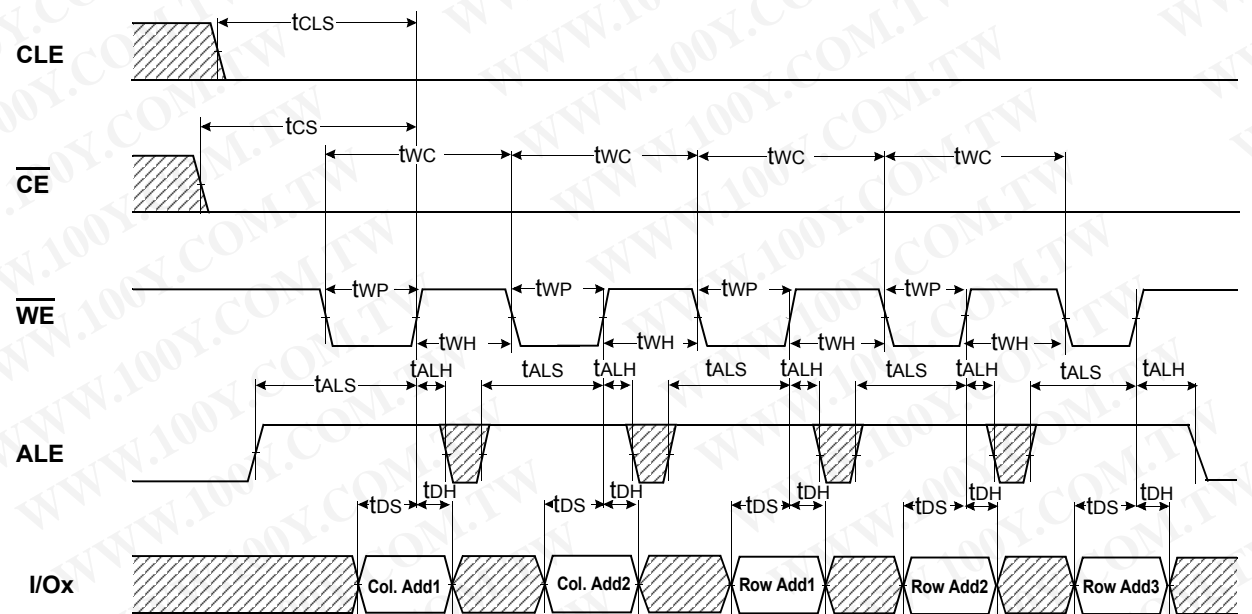

Input Data Latch Cycle

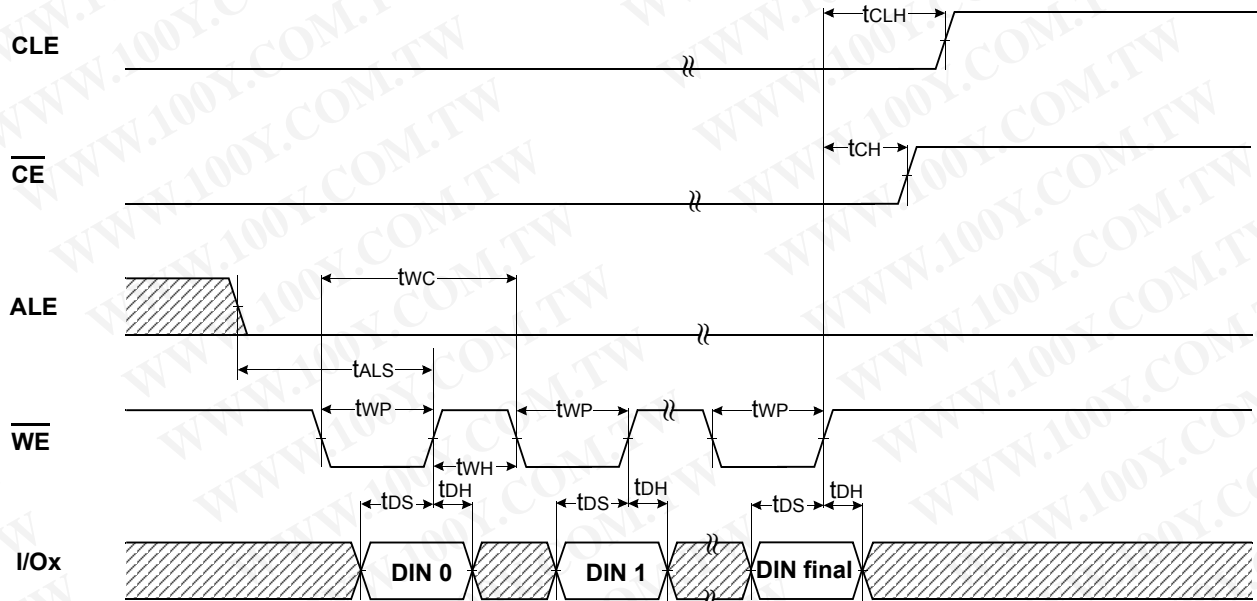

* Serial Access Cycle after Read (CLE=L, WE=H, ALE=L)

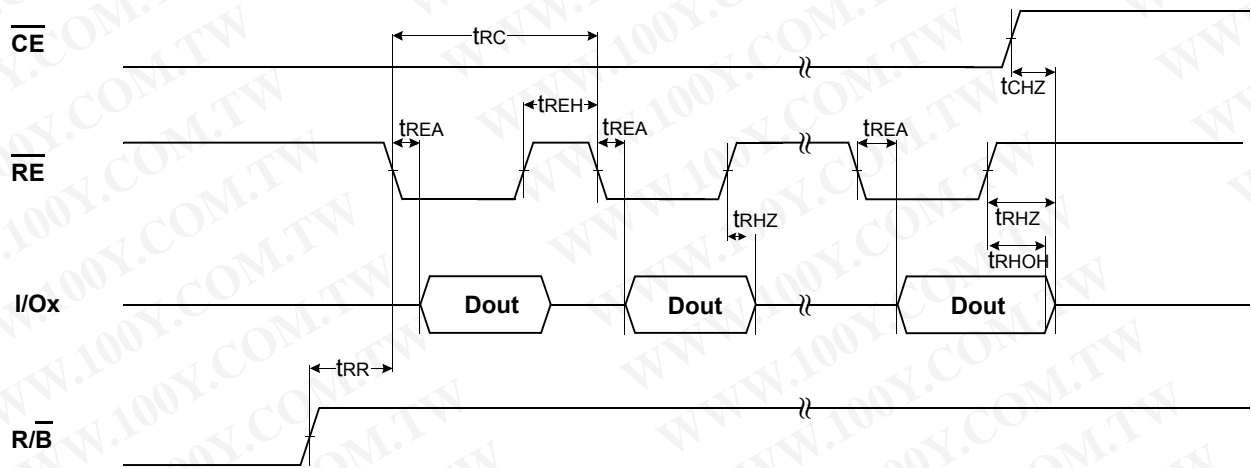

NOTES : 1. Transition is measured at $\pm 200\text{mV}$ from steady state voltage with load. This parameter is sampled and not 100% tested.
 2. tRLOH is valid when frequency is higher than 20MHz.
 tRHOH starts to be valid when frequency is lower than 20MHz.

Serial Access Cycle after Read (EDO Type, $\overline{CLE}=L$, $\overline{WE}=H$, $ALE=L$)

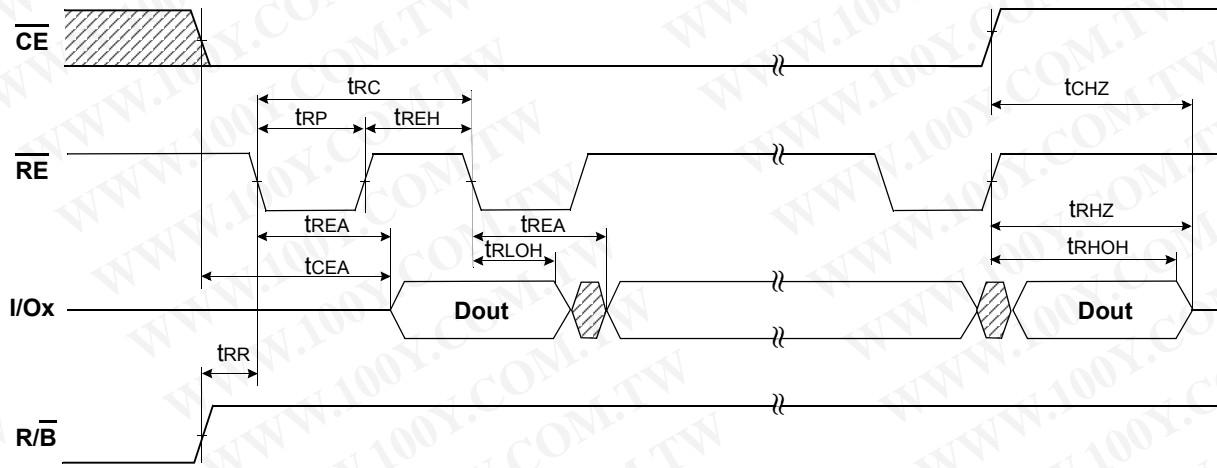

- NOTES : 1. Transition is measured at $\pm 200\text{mV}$ from steady state voltage with load. This parameter is sampled and not 100% tested.
 2. t_{RLOH} is valid when frequency is higher than 20MHz.
 t_{RHOH} starts to be valid when frequency is lower than 20MHz.

Status Read Cycle

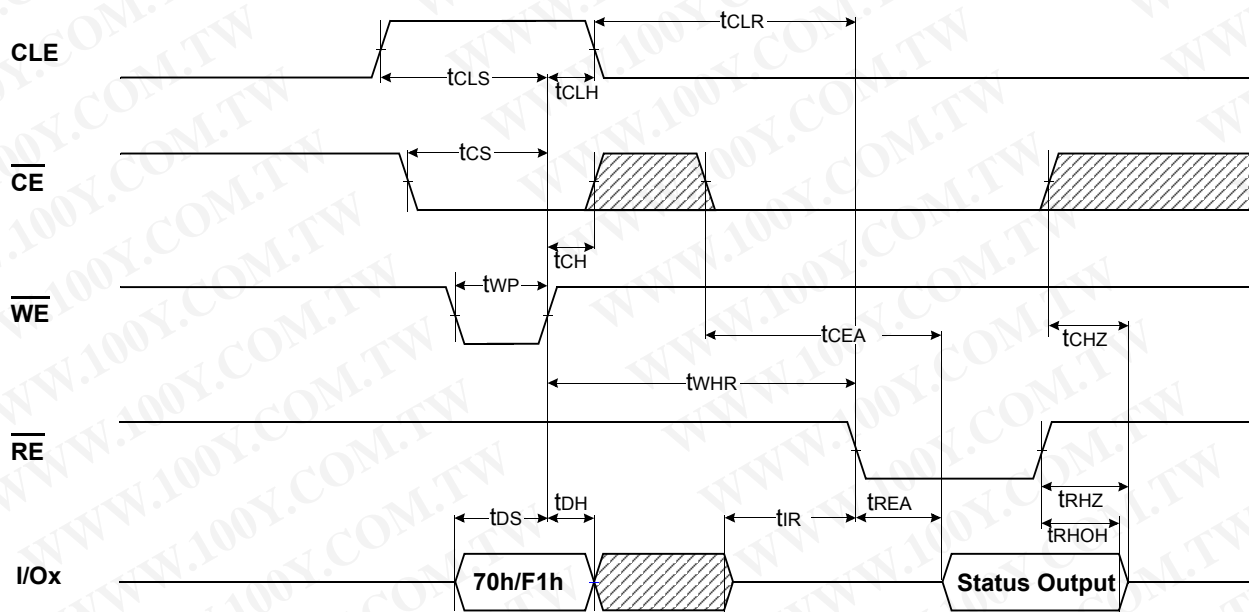

Read Operation

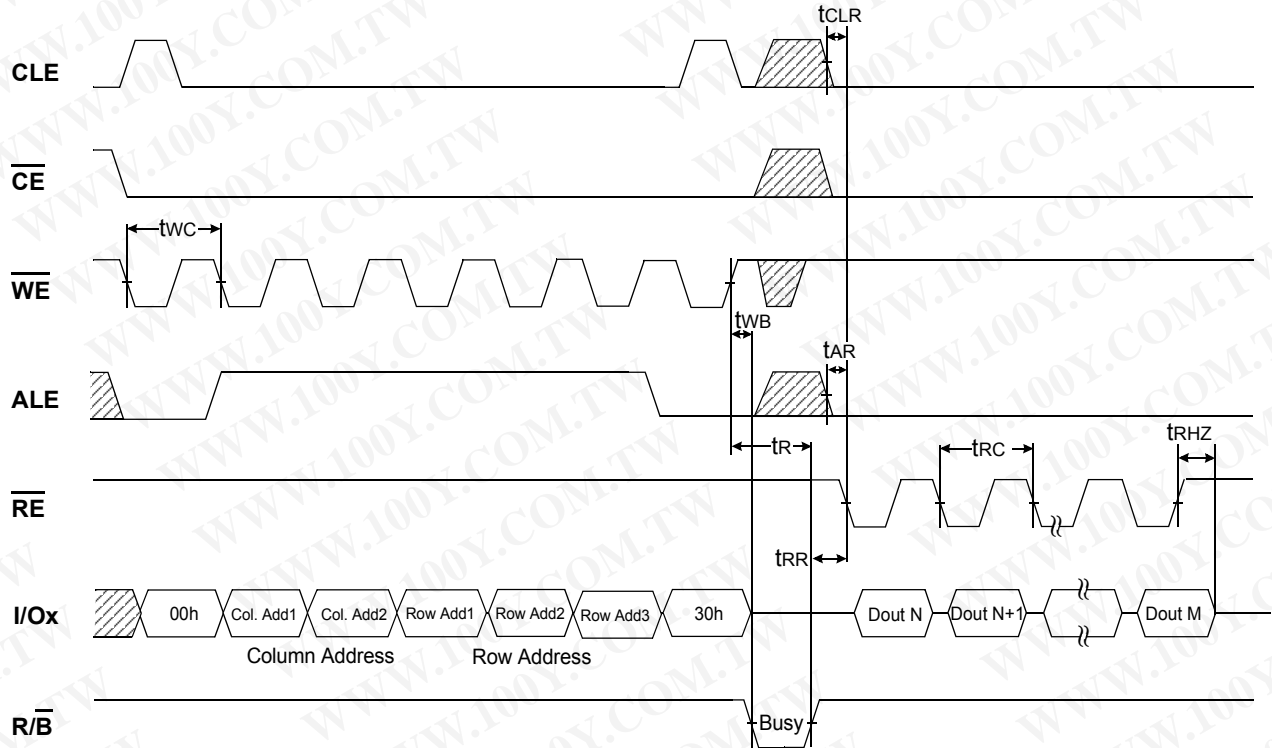

Read Operation (Intercepted by $\overline{\text{CE}}$)

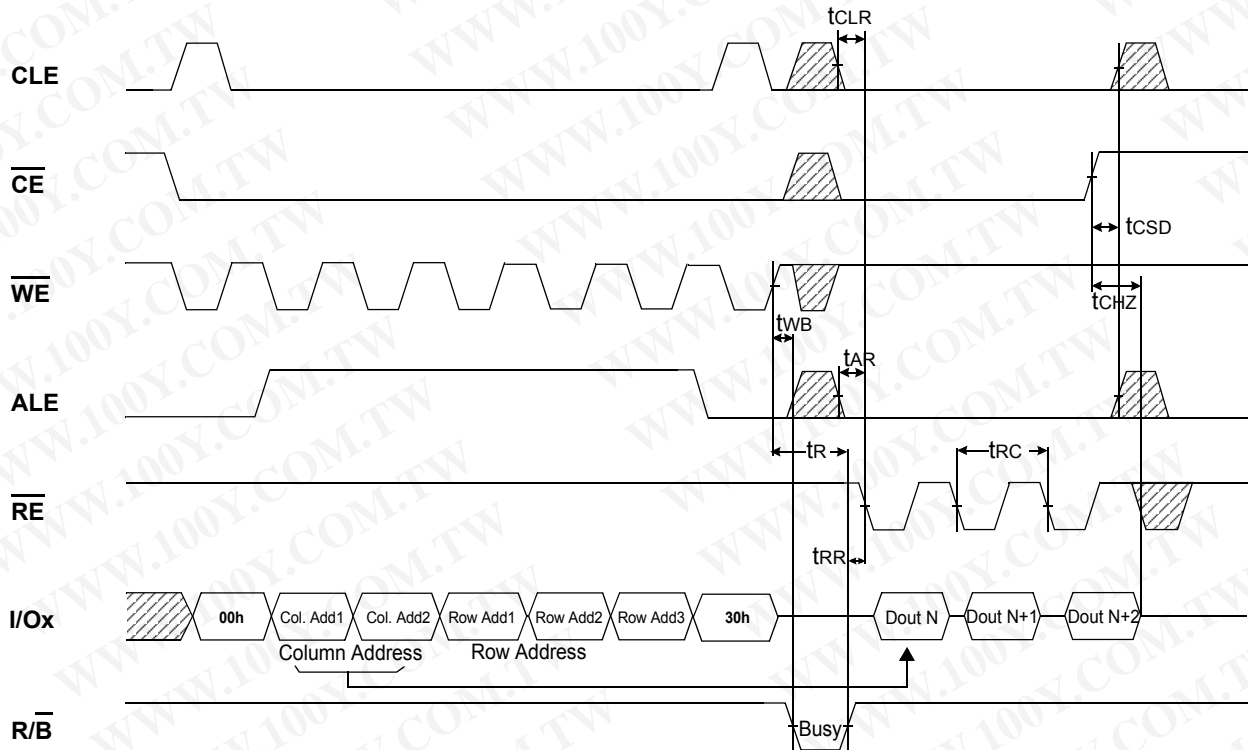

Random Data Output In a Page

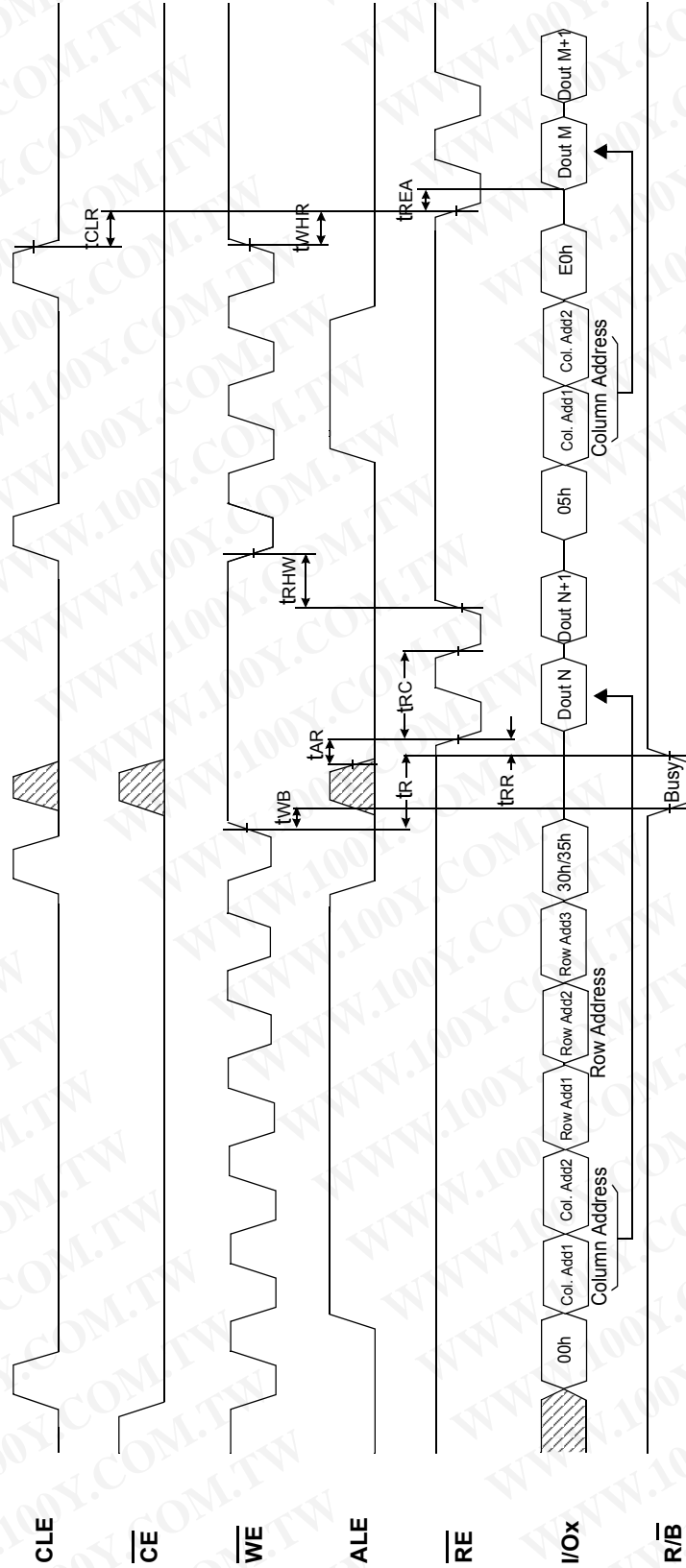

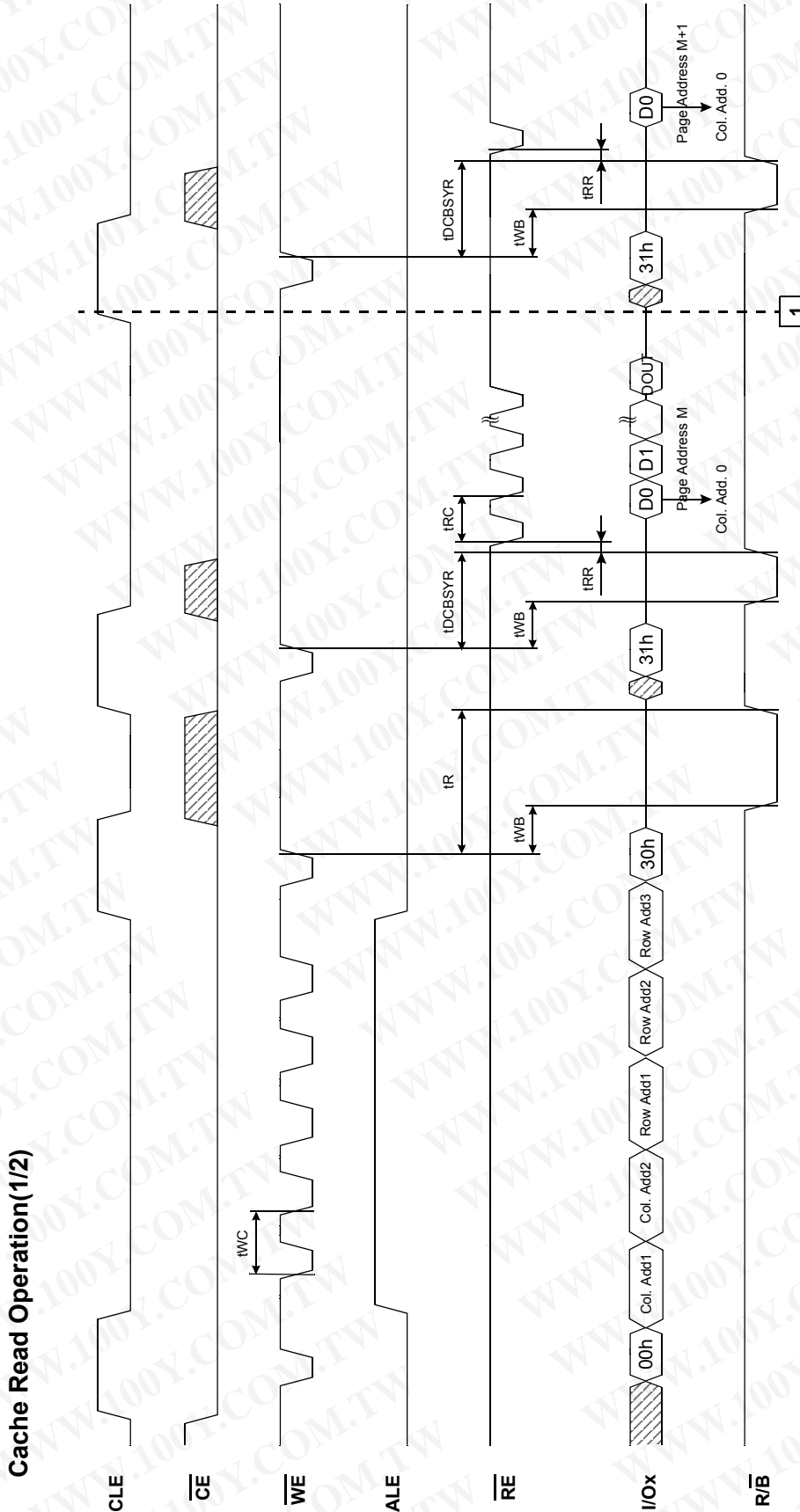

NOTES : 1. The column address will be reset to 0 by the 31h command input.
 2. Cache Read operation is available only within a block.

Cache Read Operation(2/2)

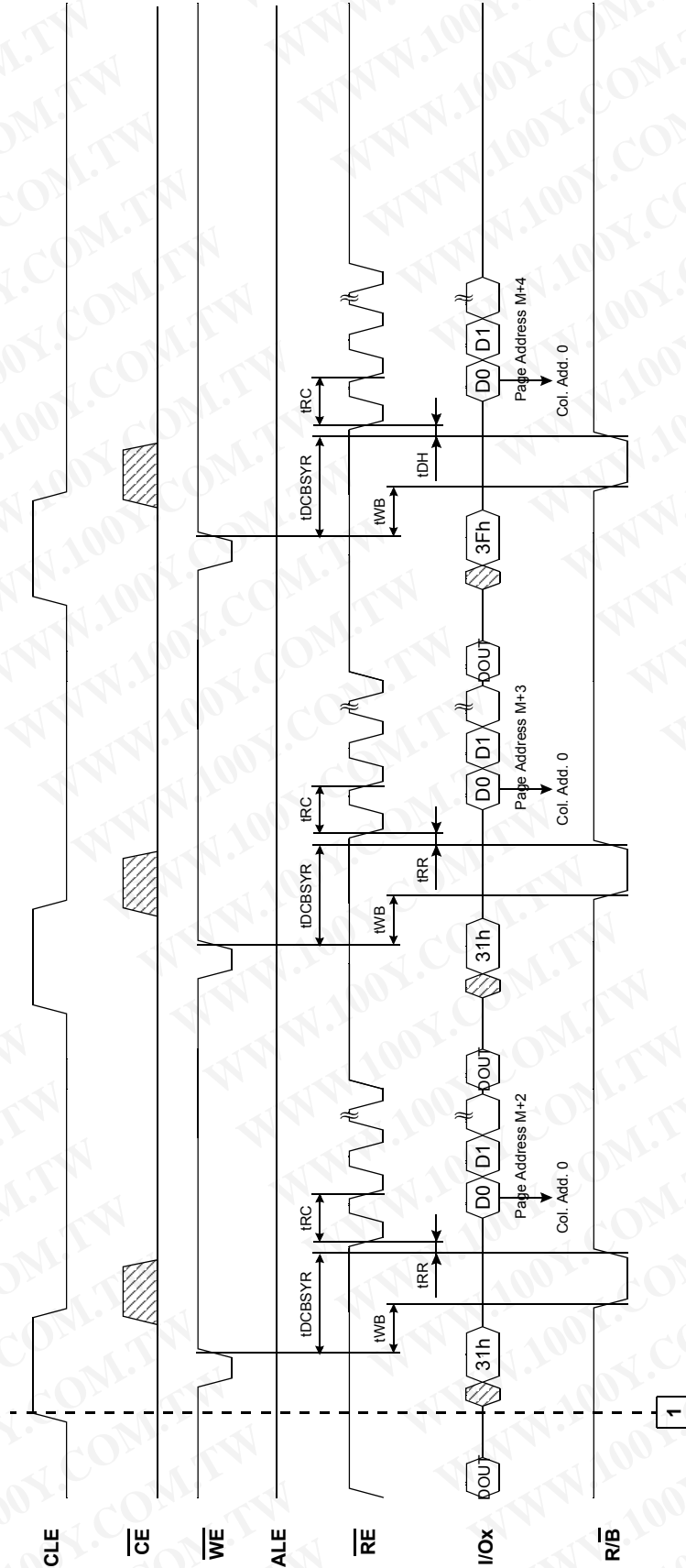

- NOTES : 1. The column address will be reset to 0 by the 31h and 3Fh command input.
 2. Cache Read operation is available only within a block.

Two-Plane Page Read Operation with Two-Plane Random Data Out

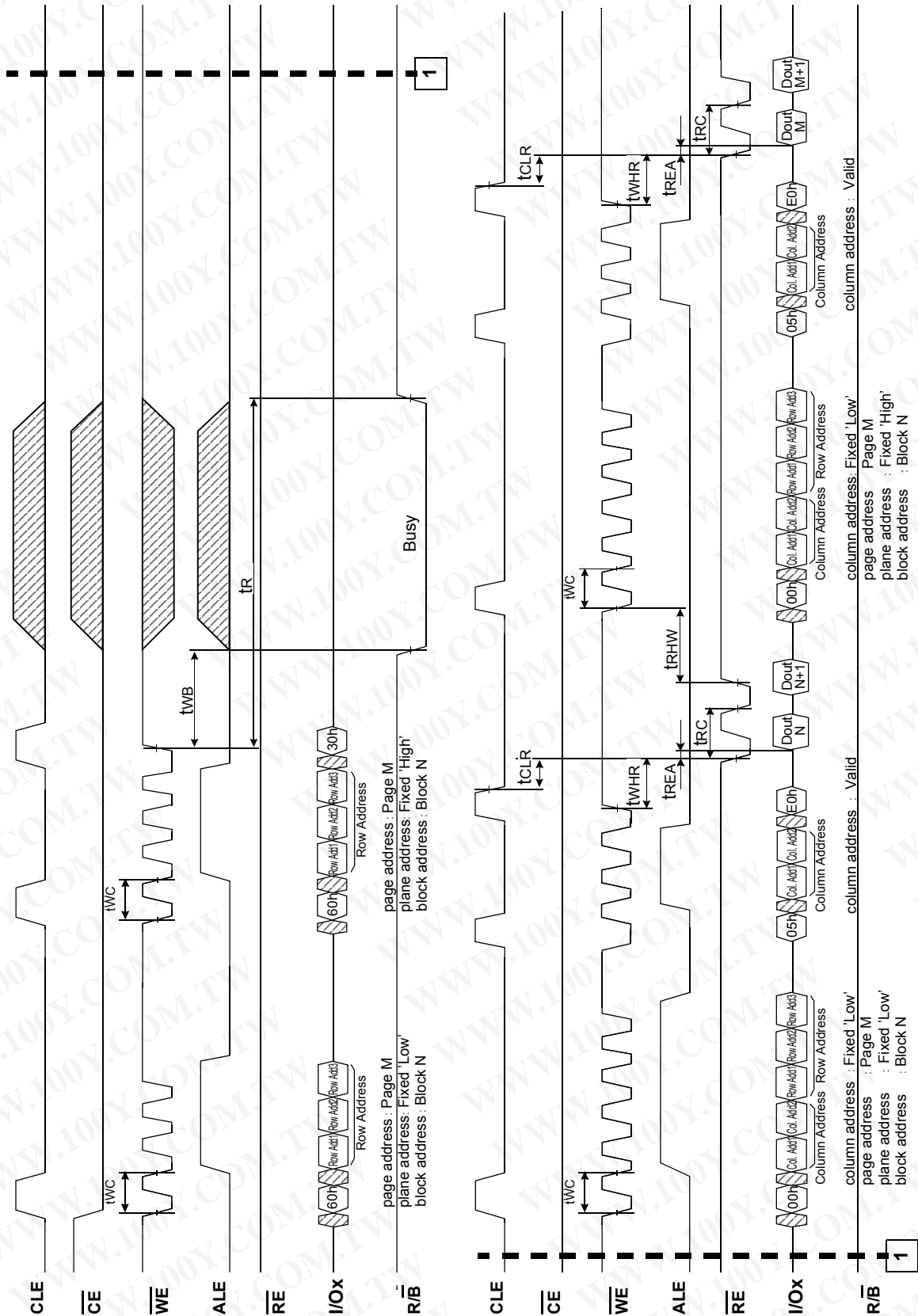

Two-Plane Cache Read Operation with Two-Plane Random Data Out (1/2)

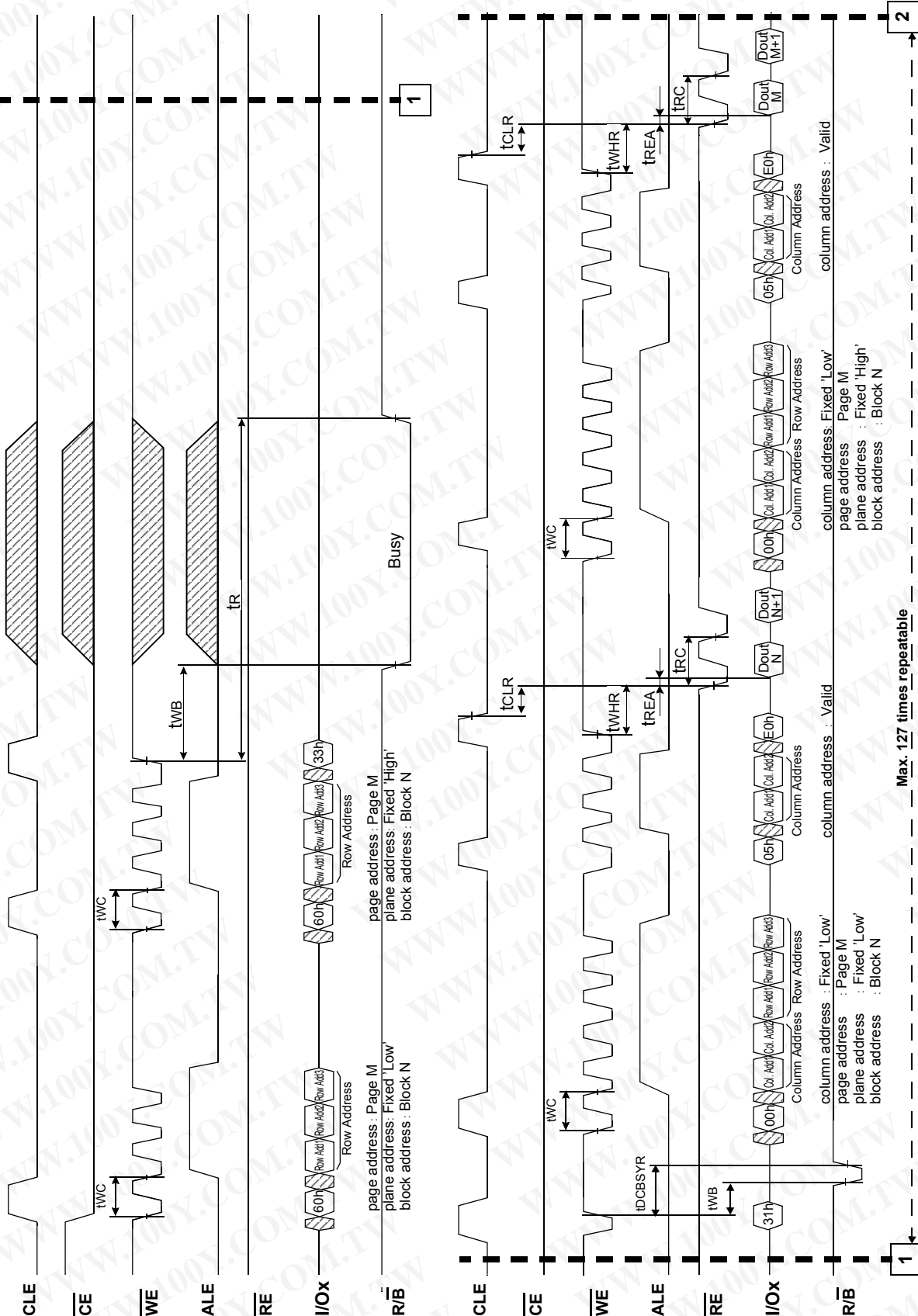

Max. 127 times repeatable

Two-Plane Cache Read Operation with Two-Plane Random Data Out (2/2)

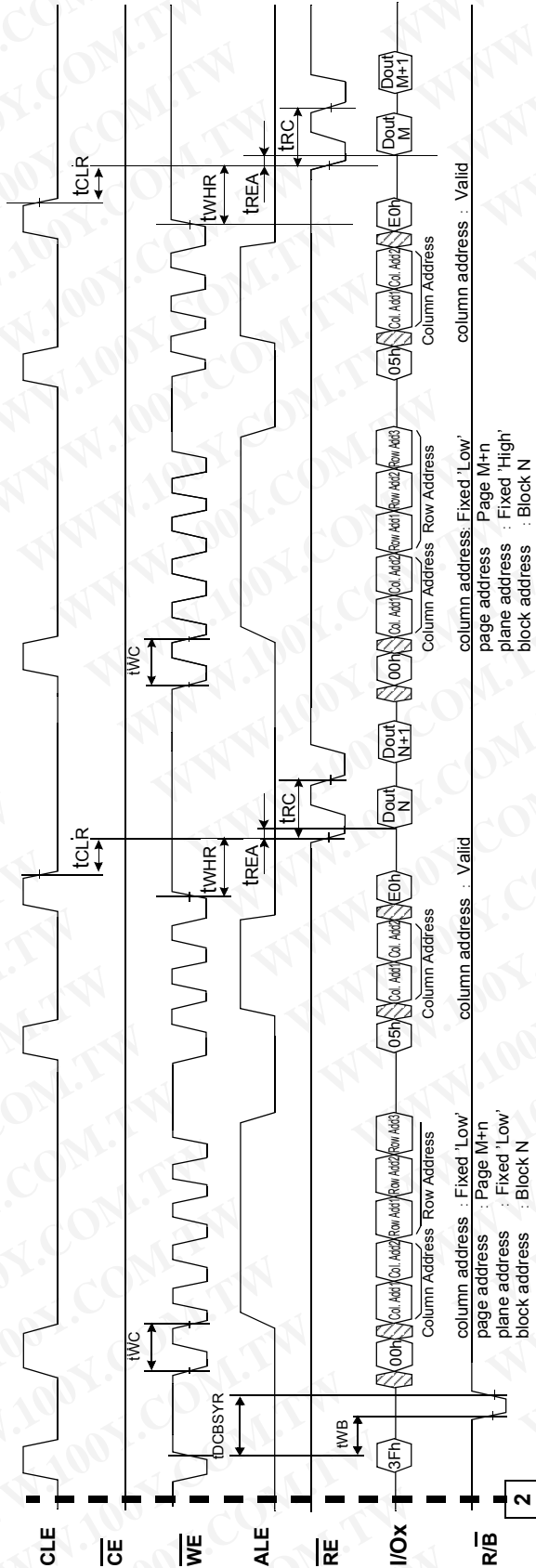

NOTES : 1. The column address will be reset to 0 by the 3Fh command input.

2. Cache Read operation is available only within a block.

3. Make sure to terminate the operation with 3Fh command. If the operation is terminated by 3Fh command, monitor I/O 6 (Ready/Busy) by issuing Status Read Command (70h) and make sure the previous page read operation is completed. If the page read operation is completed, issue FFh reset before next operation.

Page Program Operation

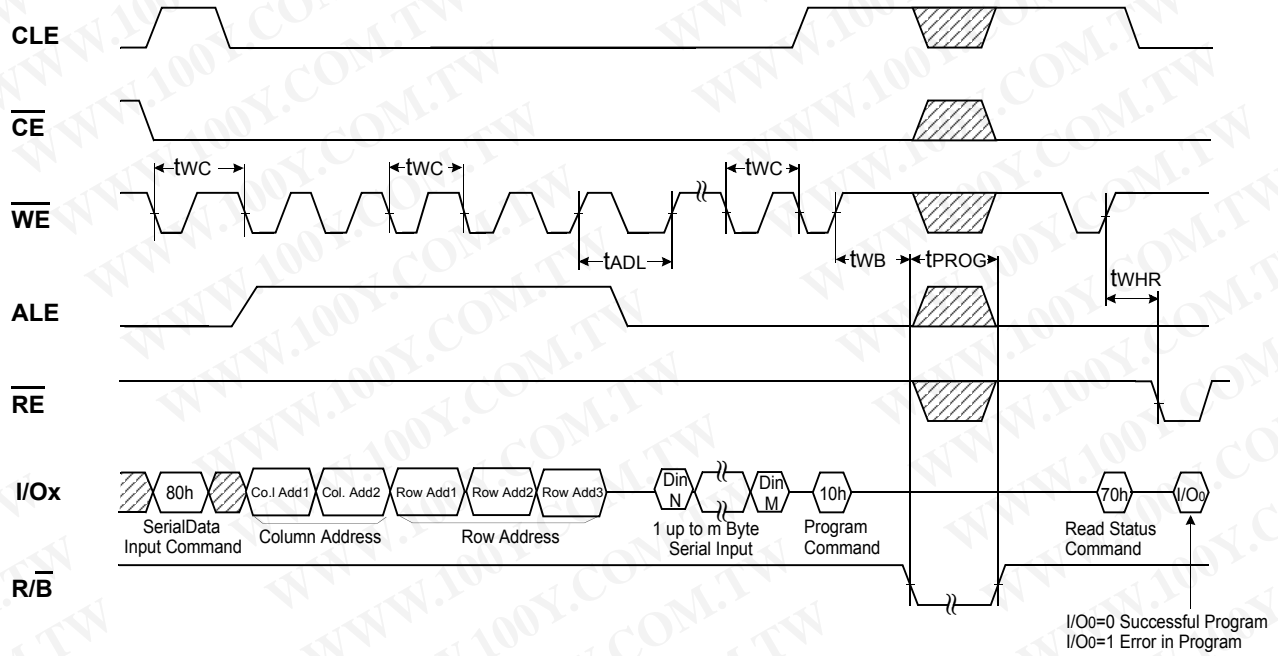

NOTES : tADL is the time from the WE rising edge of final address cycle to the WE rising edge of first data cycle.

Page Program Operation with Random Data Input

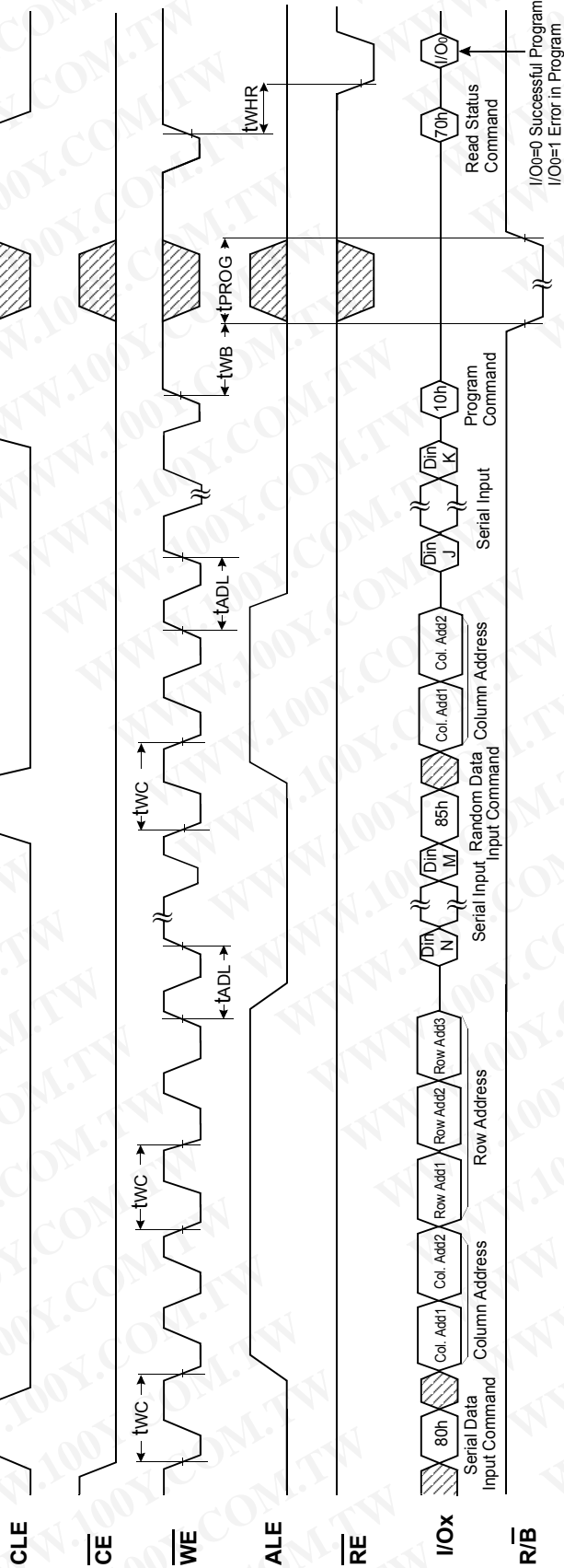

NOTES : 1. t_{ADL} is the time from the \overline{WE} rising edge of final address cycle to the \overline{WE} rising edge of first data cycle.

Copy-Back Program Operation with Random Data Input

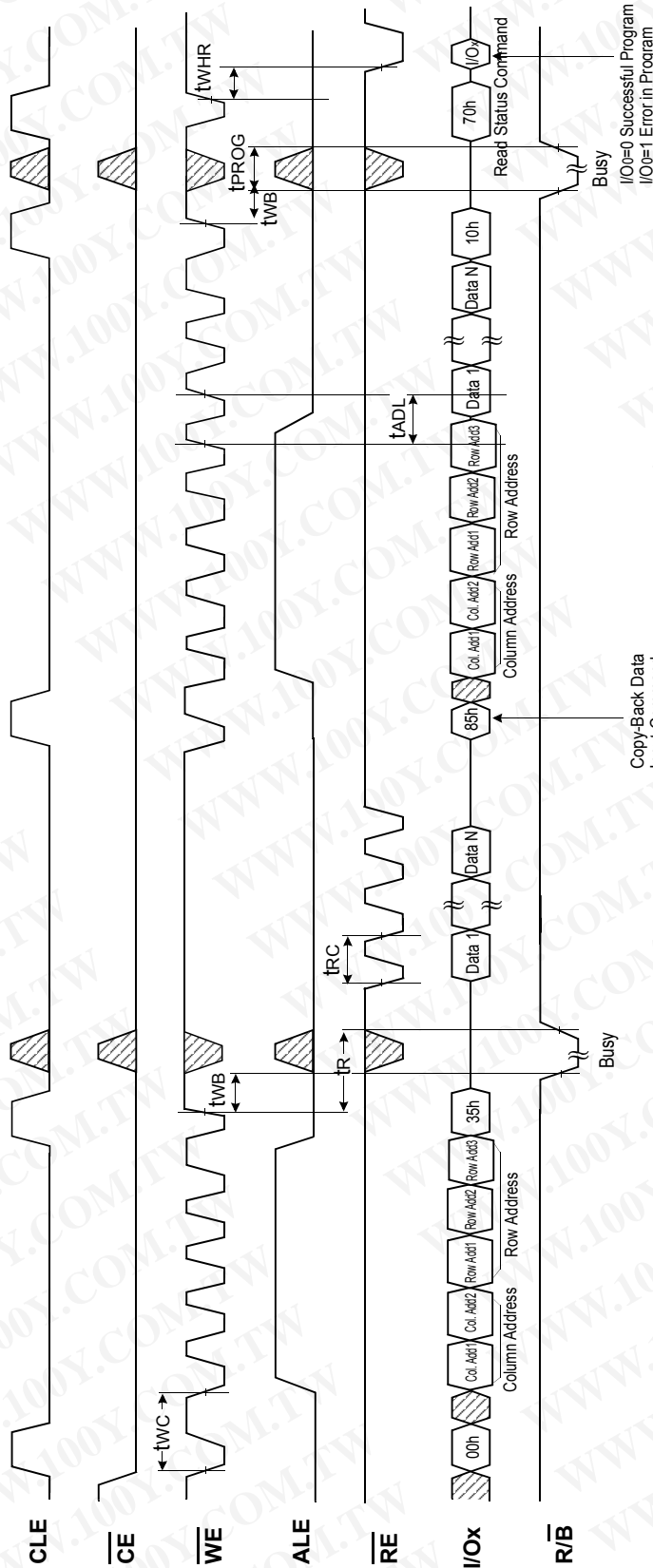

NOTES : 1. t_{ADL} is the time from the WE rising edge of final address cycle to the WE rising edge of first data cycle.

Cache Program Operation (available only within a block)

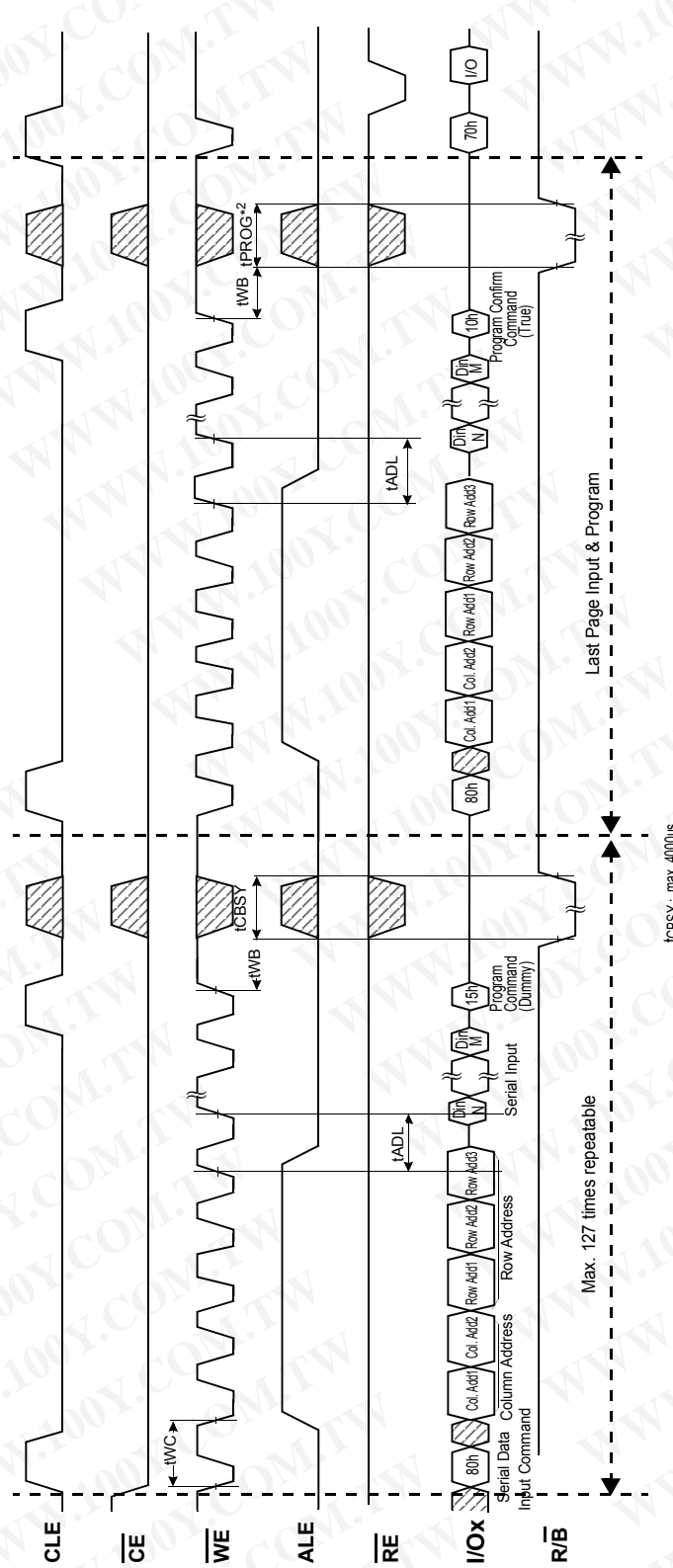

- NOTES :**
1. t_{ADL} is the time from the \overline{WE} rising edge of final address cycle to the \overline{WE} rising edge of first data cycle.
 2. Since programming the last page does not employ caching, the program time has to be that of Page Program. However, if the previous program cycle with the cache data has not finished, the actual program cycle of the last page is initiated only after completion of the previous cycle, which can be expressed as the following formula.

$$t_{PROG} = \text{Program time for the last page} + \text{Program time for the (last - 1)^{th} \text{ page} \\ - (\text{command input cycle time} + \text{address input cycle time} + \text{Last page data loading time})$$

Ex.) Cache Program

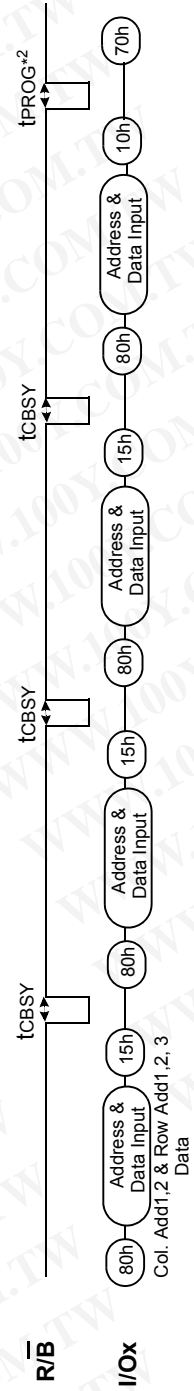

Two-Plane Page Program Operation

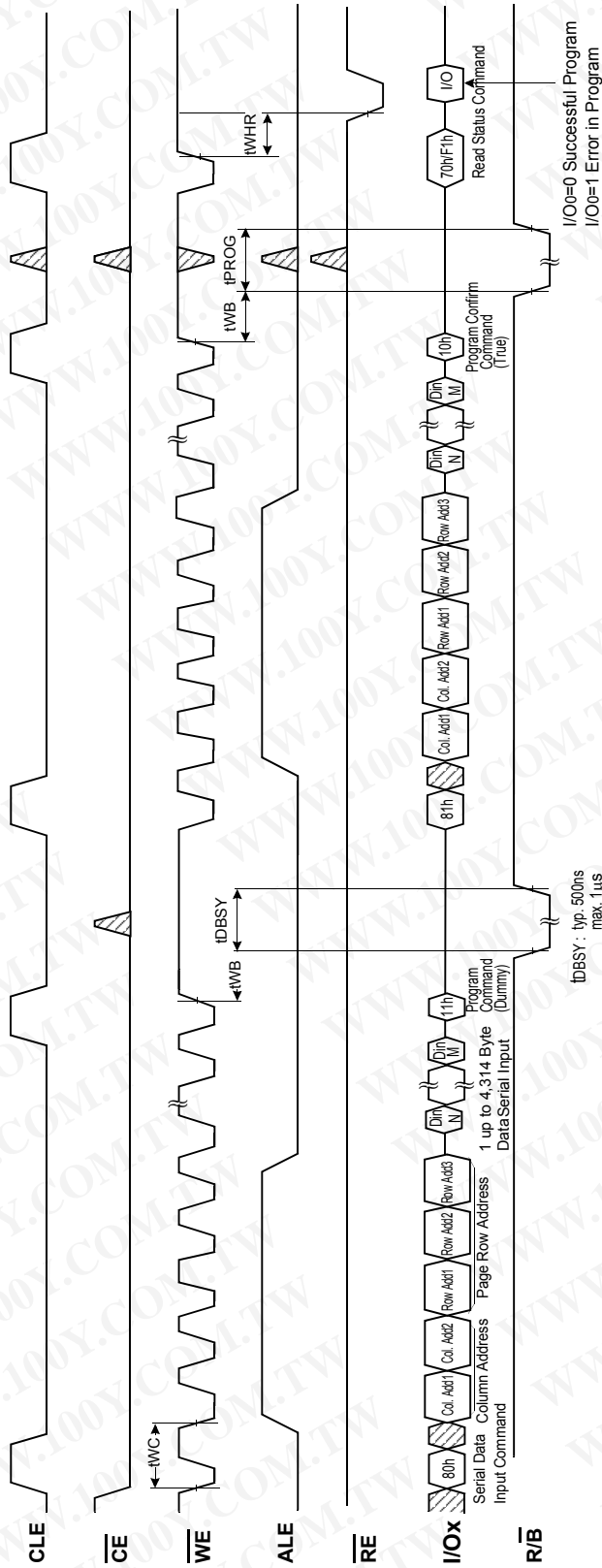

Ex.) Two-Plane Page Program

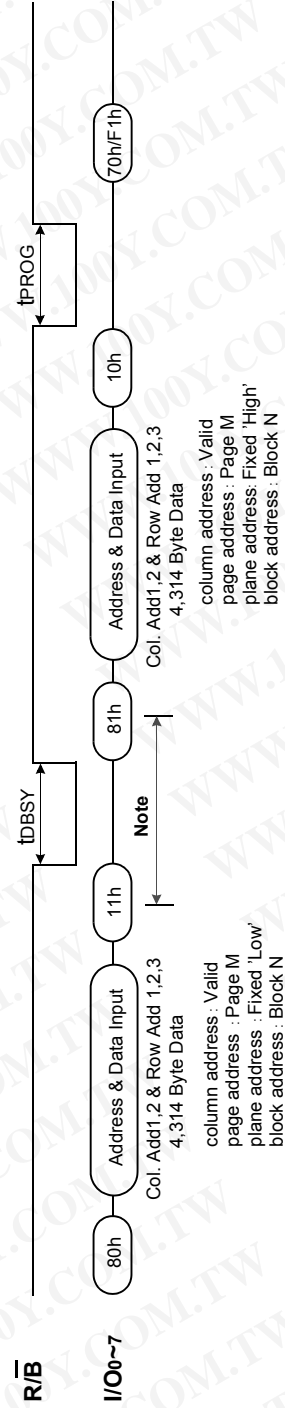

Note: Any command between 11h and 81h is prohibited except 70h/F1h and FFh.

Block Erase Operation

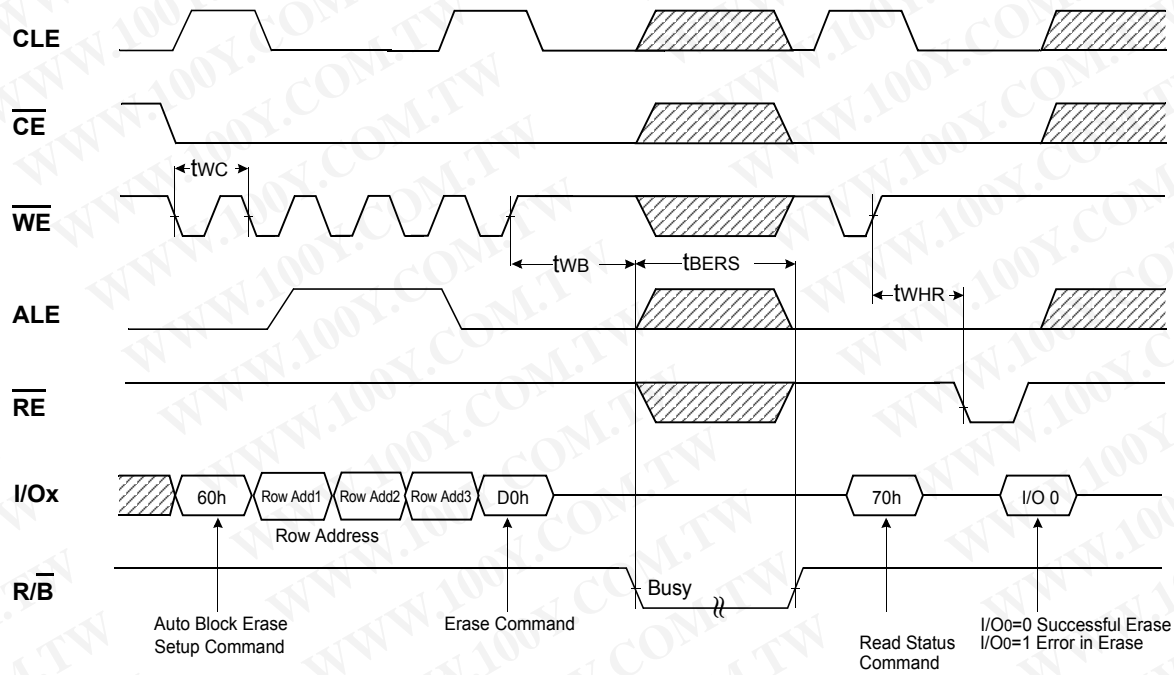

Two-Plane Block Erase Operation

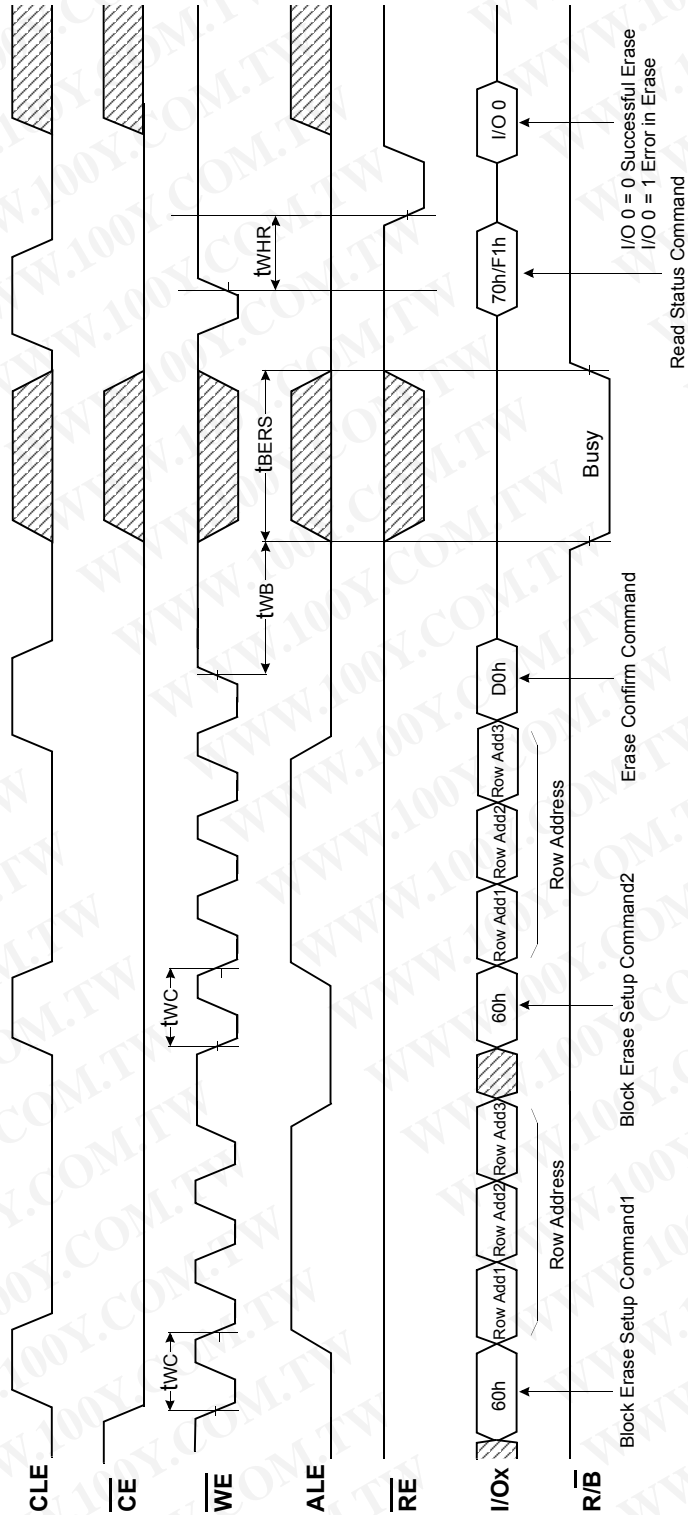

Ex.) Address Restriction for Two-Plane Block Erase Operation

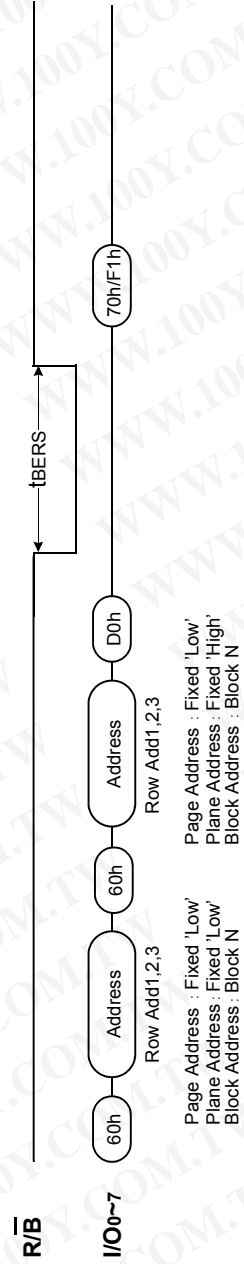

Read ID Operation

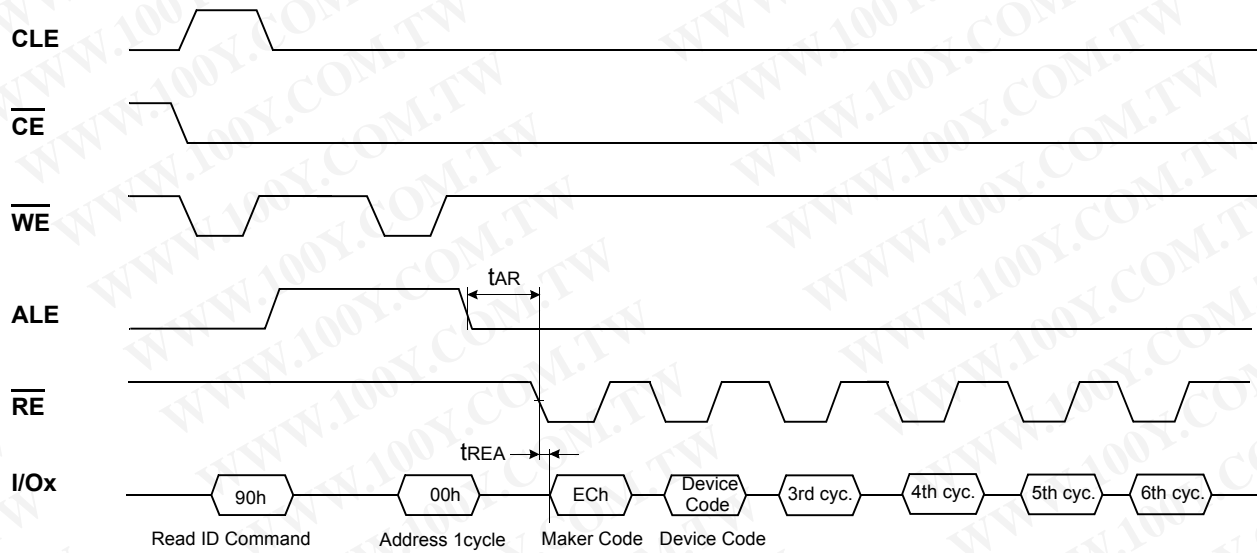

Device	Device Code (2nd Cycle)	3rd Cycle	4th Cycle	5th Cycle	6th Cycle
K9GAG08B0D	Same as K9GAG08U0D				
K9GAG08U0D	D5h	94h	29h	34h	41h
K9LBG08U1D	Same as K9GAG08U0D in it				
K9HCG08U5D	Same as K9GAG08U0D in it				

ID Definition Table

90 ID : Access command = 90H

	Description
1 st Byte	Maker Code
2 nd Byte	Device Code
3 rd Byte	Internal Chip Number, Cell Type, Number of Simultaneously Programmed Pages, Etc.
4 th Byte	Page Size, Block Size, Redundant Area Size.
5 th Byte	Plane Number, ECC Level, Organization.
6 th Byte	Device Technology, EDO, Interface.

3rd ID Data

	Description	I/O7	I/O6	I/O5	I/O4	I/O3	I/O2	I/O1	I/O0
Internal Chip Number	1							0	0
	2							0	1
	4							1	0
	8							1	1
Cell Type	2 Level Cell					0	0		
	4 Level Cell					0	1		
	8 Level Cell					1	0		
	16 Level Cell					1	1		
Number of Simultaneously Programmed Pages	1			0	0				
	2			0	1				
	4			1	0				
	8			1	1				
Interleave Program Between multiple chips	Not Support		0						
	Support		1						
Cache Program	Not Support	0							
	Support	1							

4th ID Data

	Description	I/O7	I/O6	I/O5	I/O4	I/O3	I/O2	I/O1	I/O0
Page Size (w/o redundant area)	2KB							0	0
	4KB							0	1
	8KB							1	0
	Reserved							1	1
Block Size (w/o redundant area)	128KB	0		0	0				
	256KB	0		0	1				
	512KB	0		1	0				
	1MB	0		1	1				
	Reserved	1		0	0				
	Reserved	1		0	1				
	Reserved	1		1	0				
Reserved	1		1	1					
Redundant Area Size (byte / Page Size)	Reserved		0			0	0		
	128B		0			0	1		
	218B		0			1	0		
	Reserved		0			1	1		
	Reserved		1			0	0		
	Reserved		1			0	1		
	Reserved		1			1	0		
Reserved		1			1	1			

5th ID Data

	Description	I/O7	I/O6	I/O5	I/O4	I/O3	I/O2	I/O1	I/O0
Plane Number	1					0	0		
	2					0	1		
	4					1	0		
	8					1	1		
ECC Level	1bit / 512B		0	0	0				
	2bit / 512B		0	0	1				
	4bit / 512B		0	1	0				
	8bit / 512B		0	1	1				
	16bit / 512B		1	0	0				
	Reserved		1	0	1				
	Reserved		1	1	0				
Reserved		1	1	1					
Reserved		0						0	0

6th ID Data

	Description	I/O7	I/O6	I/O5	I/O4	I/O3	I/O2	I/O1	I/O0
Device Version	50nm						0	0	0
	40nm						0	0	1
	Reserved						0	1	0
	Reserved						0	1	1
	Reserved						1	0	0
	Reserved						1	0	1
	Reserved						1	1	0
	Reserved						1	1	0
EDO	Not Support		0						
	Support		1						
Interface	SDR	0							
	DDR	1							
Reserved				0	0	0			

Device Operation

PAGE READ

Page read is initiated by writing 00h-30h to the command register along with five address cycles. After initial power up, 00h command is latched. Therefore only five address cycles and 30h command initiates that operation after initial power up. The 4,314 bytes of data within the selected page are transferred to the cache registers via data registers in less than 60 μ s(t_R). The system controller can detect the completion of this data transfer(t_R) by analyzing the output of R/B pin. Once the data in a page is loaded into the cache registers, they may be read out in 30ns cycle time by sequentially pulsing RE. The repetitive high to low transitions of the RE clock make the device output the data starting from the selected column address up to the last column address.

The device may output random data in a page instead of the consecutive sequential data by writing random data output command. The column address of next data, which is going to be out, may be changed to the address which follows random data output command. Random data output can be operated multiple times regardless of how many times it is done in a page.

Figure 6. Read Operation

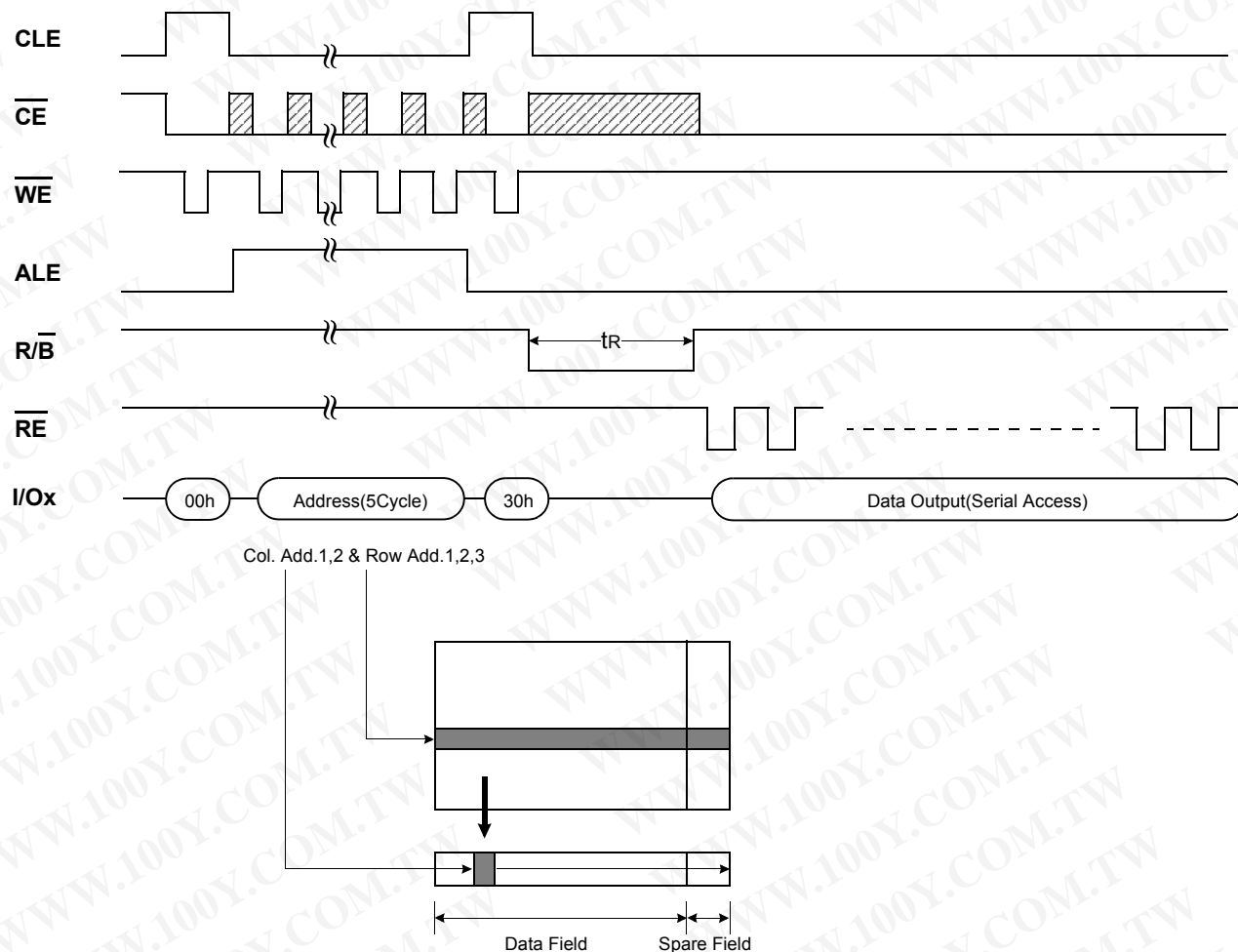
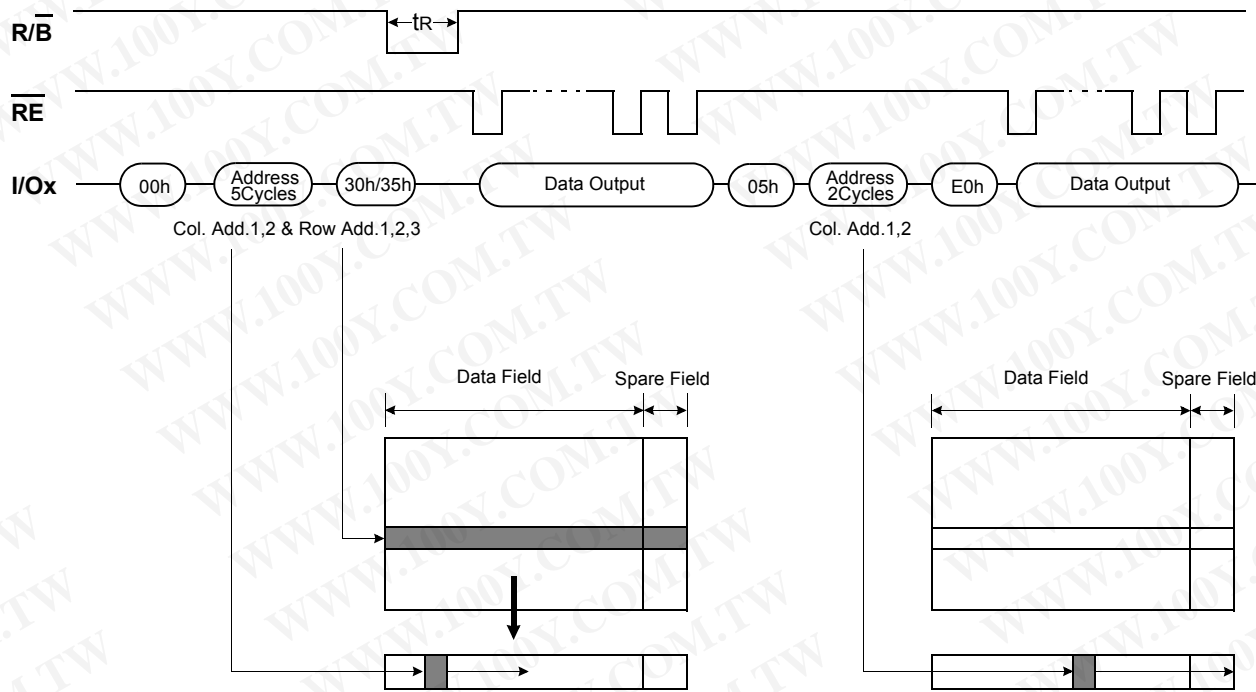

Figure 7. Random Data Output In a Page



CACHE READ

Cache Read is an extension of Page Read, which is executed with 4,314byte data registers, and is available only within a block. Since the device has 1 page of cache memory, serial data output may be executed while data in the memory cell is read into cache registers.

Cache read is also initiated by writing 00h-30h to the command register along with five address cycles. After initial power up, 00h command is latched. Therefore only five address cycles and 30h command initiates that operation after initial power up. The 4,314 bytes of data within the selected page are transferred to the cache registers via data registers in less than $60\mu s(t_R)$. After issuing Cache Read command(31h), read data in the data registers is transferred to cache registers for a short period of time(t_{DCBSYR}). While the data in the cache registers is read out in 30ns cycle time by sequentially pulsing RE, data of next page is transferred to the data registers. By issuing Last Cache Read command(3Fh), last data is transferred to the cache registers from the data registers after the completion of transfer from memory cell to data registers. Cache Read is available only within a block.

Figure 8. Cache Read

The device has a Read operation with cache registers that enables the high speed read operation shown below. When the block address changes, this sequence has to be started from the beginning.

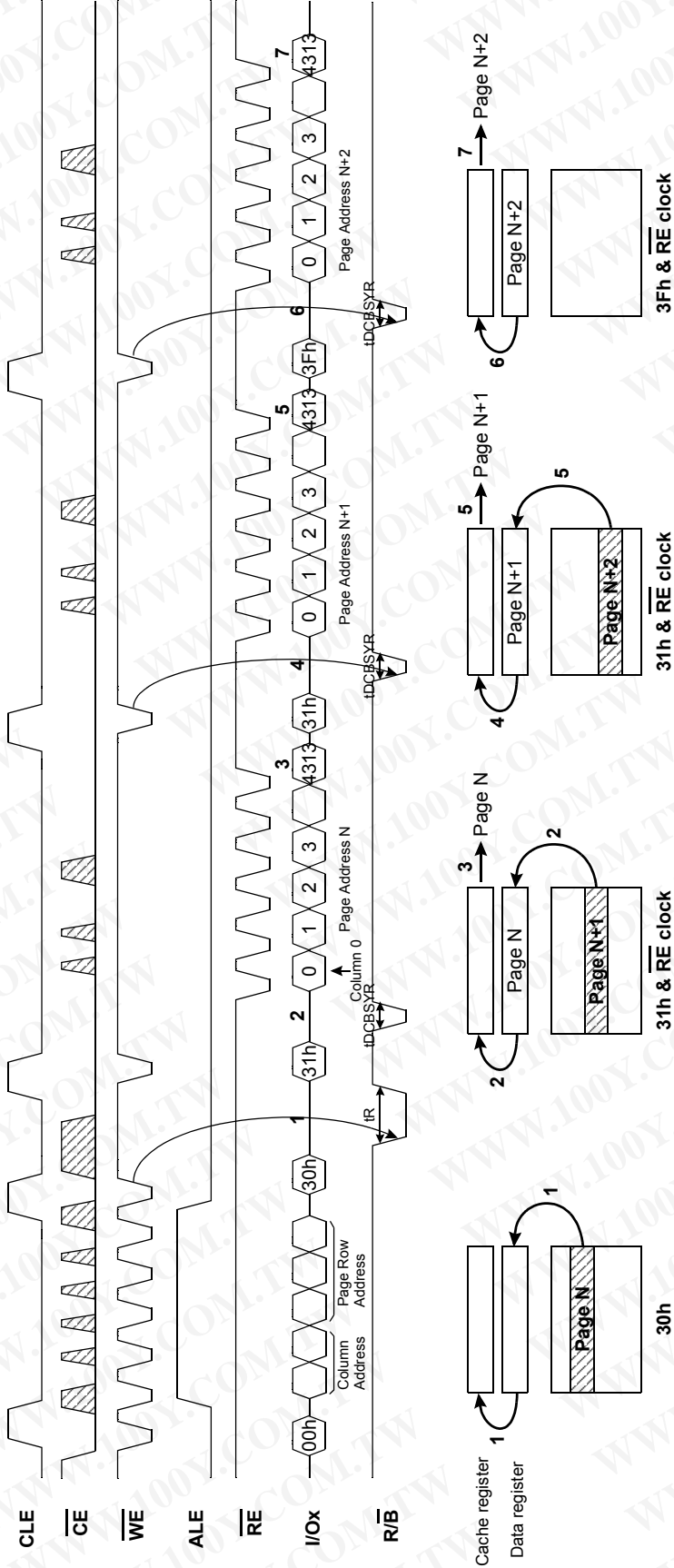

TWO-PLANE PAGE READ

Two-Plane Page Read is an extension of Page Read, for a single plane with 4,314 byte data registers. Since the device is equipped with two memory planes, activating the two sets of 4,314 byte data registers enables a random read of two pages. Two-Plane Page Read is initiated by repeating command 60h followed by three address cycles twice. **In this case, only same page of same block can be selected from each plane.**

After Read Confirm command(30h) the 8,628 bytes of data within the selected two page are transferred to the cache registers via data registers in less than 60us(tR). The system controller can detect the completion of data transfer(tR) by monitoring the output of R/B pin.

Once the data is loaded into the cache registers, the data output of first plane can be read out by issuing command 00h with Five Address Cycles, command 05h with two column address and finally E0h. The data output of second plane can be read out using the identical command sequences.

Figure 9. Two-Plane Page Read Operation with Two-Plane Random Data Out

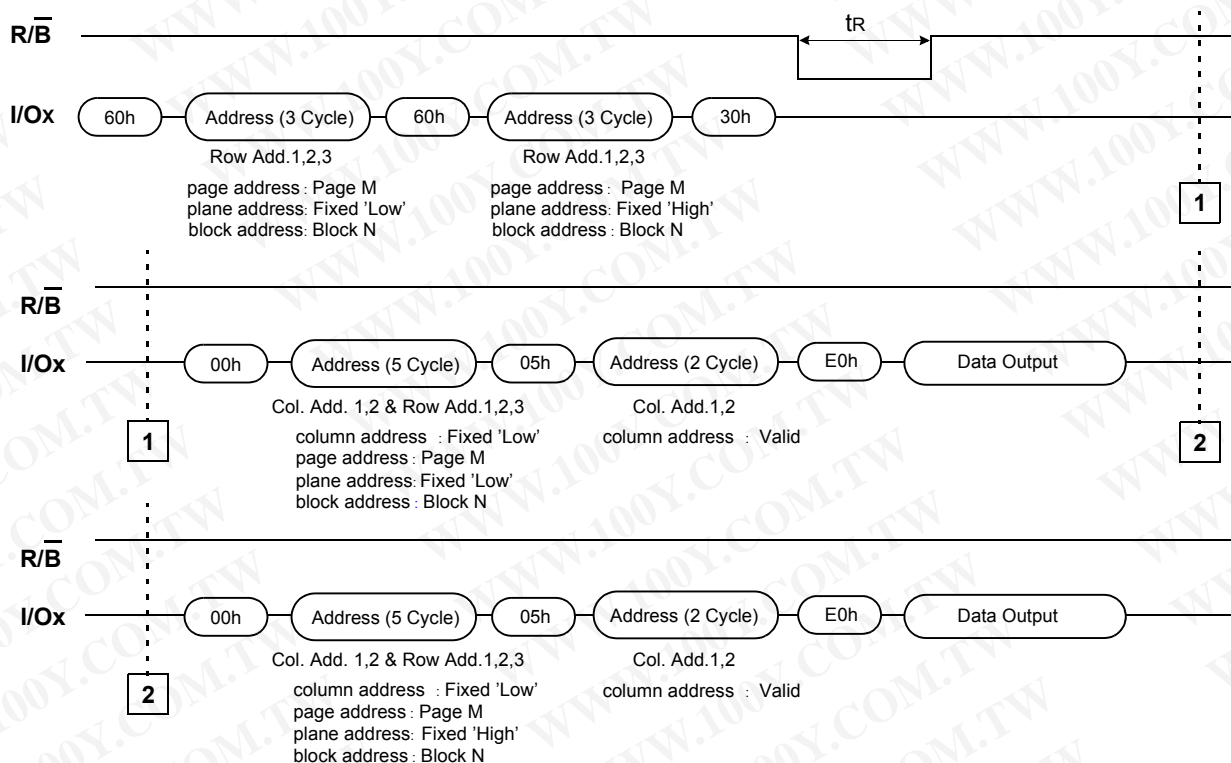

TWO-PLANE CACHE READ

Two-Plane Cache Read is an extension of Cache Read, for a single plane with 4,314 byte data registers. Since the device is equipped with two memory planes, activating the two sets of 4,314 byte data registers enables a cache read of two pages. Two-Plane Cache Read is initiated by repeating command 60h followed by three address cycles twice. In this case only same page of same block can be selected from each plane.

After Read Confirm command(33h) the 8,628 bytes of data within the selected two page are transferred to the cache registers via data registers in less than 60us(t_R). After issuing Cache Read command(31h), read data in the data registers is transferred to cache registers for a short period of time(t_{DCBSYR}). Once the data is loaded into the cache registers from data registers, the data output of first plane can be read out by issuing command 00h with Five Address Cycles, command 05h with two column address and finally E0h. The data output of second plane can be read out using the identical command sequences. The detail sequence of Two-Plane Cache Read is shown in Figure 10.

Figure 10. Two-Plane Cache Read Operation with Two-Plane Random Data Out

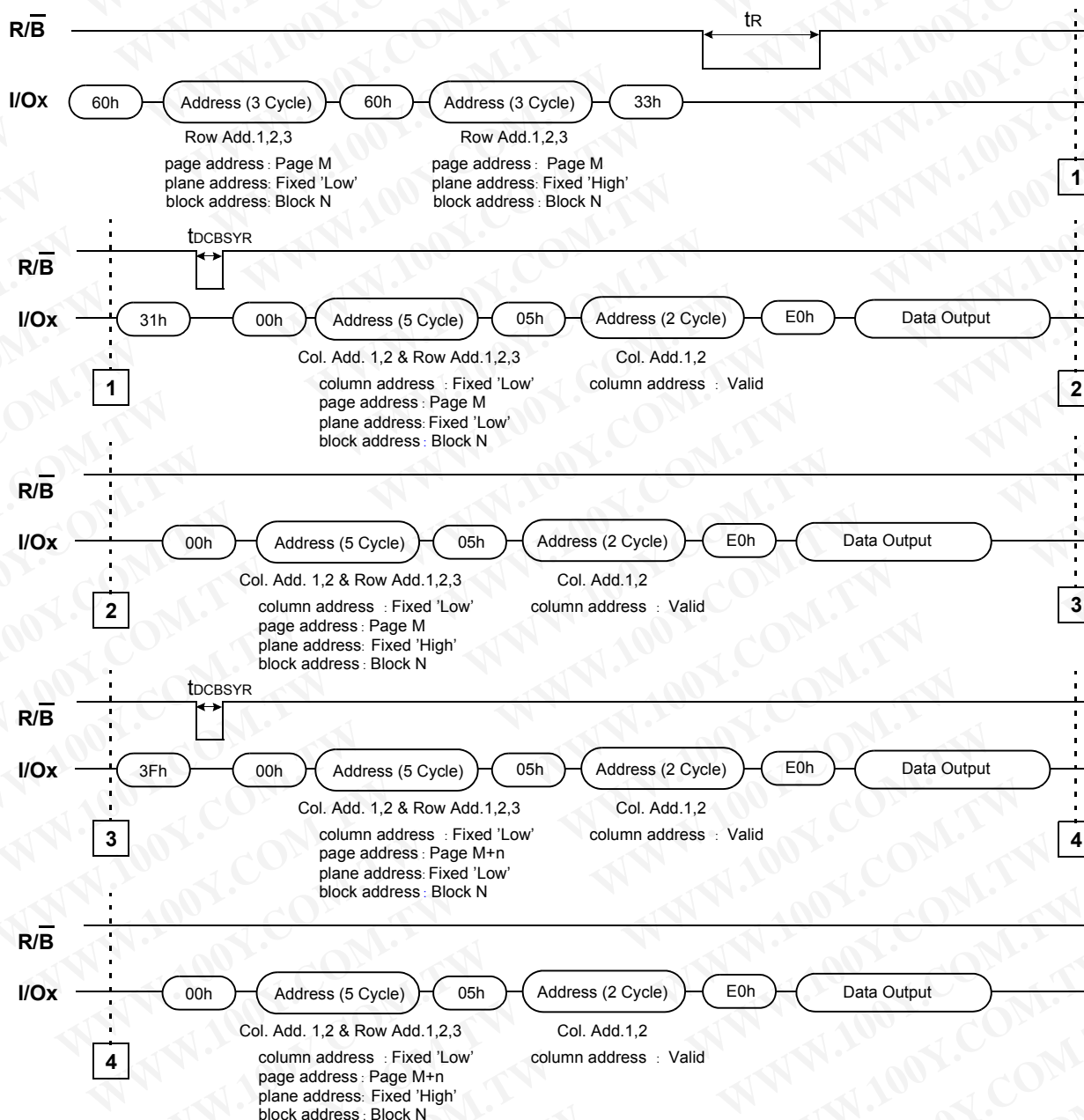

PAGE PROGRAM

The device is programmed basically on a page basis, and the number of consecutive partial page programming operation within the same page without an intervening erase operation must not exceed 1 time for the page. The addressing should be done in sequential order in a block. A page program cycle consists of a serial data loading period in which up to 4,314bytes of data may be loaded into the data registers via cache registers, followed by a non-volatile programming period where the loaded data is programmed into the appropriate cell.

The serial data loading period begins by inputting the Serial Data Input command(80h), followed by the five cycle address inputs and then serial data loading. The words other than those to be programmed do not need to be loaded. The device supports random data input in a page. The column address for the next data, which will be entered, may be changed to the address which follows random data input command(85h). Random data input may be operated multiple times regardless of how many times it is done in a page.

The Page Program confirm command(10h) initiates the programming process. Writing 10h alone without previously entering the serial data will not initiate the programming process. The internal write state controller automatically executes the algorithms and timings necessary for program and verify, thereby freeing the system controller for other tasks. Once the program process starts, the Read Status Register command may be entered to read the status register. The system controller can detect the completion of a program cycle by monitoring the R/B output, or the Status bit(I/O 6) of the Status Register. Only the Read Status command and Reset command are valid while programming is in progress. When the Page Program is complete, the Write Status Bit(I/O 0) may be checked. The internal write verify detects only errors for "1"s that are not successfully programmed to "0"s. The command register remains in Read Status command mode until another valid command is written to the command register.

Figure 11. Program & Read Status Operation

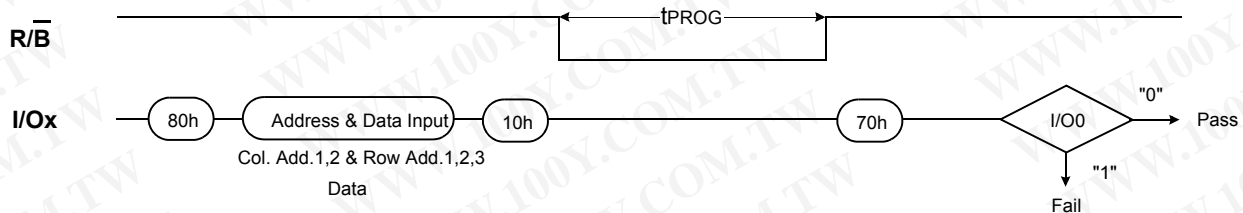
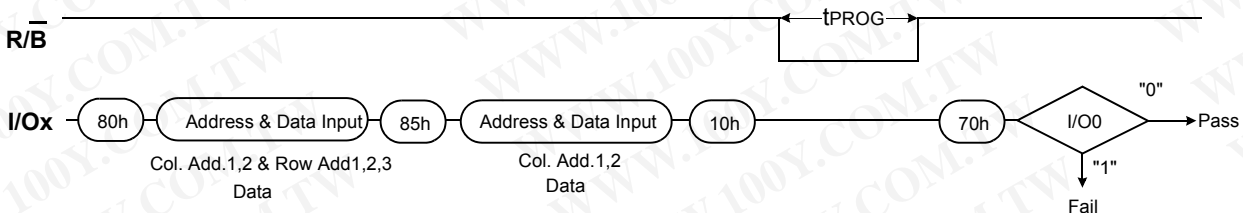

Figure 12. Random Data Input In a Page



COPY-BACK PROGRAM

Copy-Back program with Read for Copy-Back is configured to quickly and efficiently rewrite data stored in one page without data re-loading when the bit error is not in data stored. Since the time-consuming re-loading cycles are removed, the system performance is improved. The benefit is especially obvious when a portion of a block is updated and the rest of the block also needs to be copied to the newly assigned free block. Copy-Back operation is a sequential execution of Read for Copy-Back and of copy-back program with the destination page address. A read operation with "35h" command and the address of the source page moves the whole 4,314-byte data into the internal data buffer. A bit error is checked by sequential reading the data output. In the case where there is no bit error, the data do not need to be reloaded. Therefore Copy-Back program operation is initiated by issuing Page-Copy Data-Input command (85h) with destination page address. Actual programming operation begins after Program Confirm command (10h) is issued. Once the program process starts, the Read Status Register command (70h) may be entered to read the status register. The system controller can detect the completion of a program cycle by monitoring the R/B output, or the Status bit(I/O 6) of the Status Register. When the Copy-Back Program is complete, the Write Status Bit(I/O 0) may be checked(Figure 13 & Figure 14). The command register remains in Read Status command mode until another valid command is written to the command register. During copy-back program, data modification is possible using random data input command (85h) as shown in Figure 14.

Figure 13. Page Copy-Back Program Operation

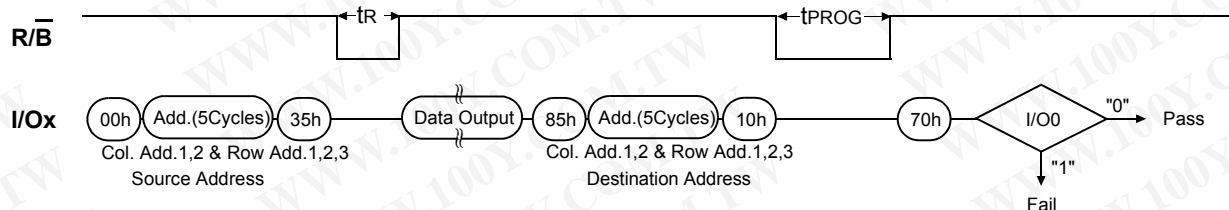

Note: 1. Copy-Back Program operation is allowed only within the same memory plane.

Figure 14. Page Copy-Back Program Operation with Random Data Input

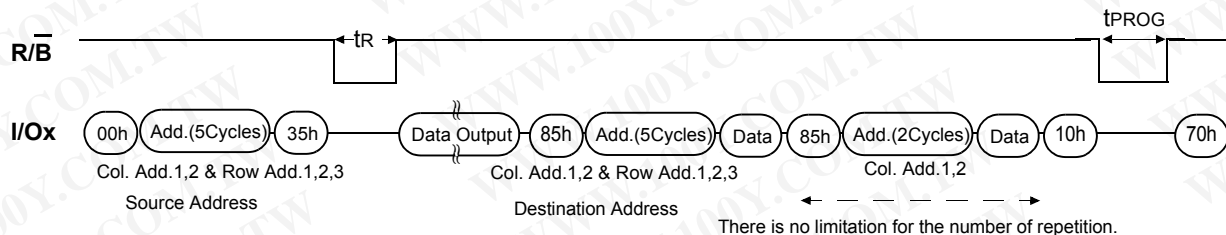

CACHE PROGRAM

Cache Program is an extension of Page Program, which is executed with 4314byte data registers, and is available only within a block. Since the device has 1 page of cache memory, serial data input may be executed while data stored in data registers are programmed into memory cell.

After writing the first set of data up to 4314byte into the selected cache registers, Cache Program command (15h) instead of actual Page Program (10h) is inputted to make cache registers free and to start internal program operation. To transfer data from cache registers to data registers, the device remains in Busy state for a short period of time(t_{CBSY}) and has its cache registers ready for the next data-input while the internal programming gets started with the data loaded into data registers. Read Status command (70h) may be issued to find out when cache registers become ready by polling the Cache-Busy status bit(I/O 6). Pass/fail status of only the previous page is available upon the return to Ready state. When the next set of data is inputted with the Cache Program command, t_{CBSY} is affected by the progress of pending internal programming. The programming of the cache registers is initiated only when the pending program cycle is finished and the data registers are available for the transfer of data from cache registers. The status bit(I/O5) for internal Ready/Busy may be polled to identify the completion of internal programming. If the system monitors the progress of programming only with R/B, the last page of the target programming sequence must be programmed with actual Page Program command (10h).

Figure 15. Cache Program(1/2)

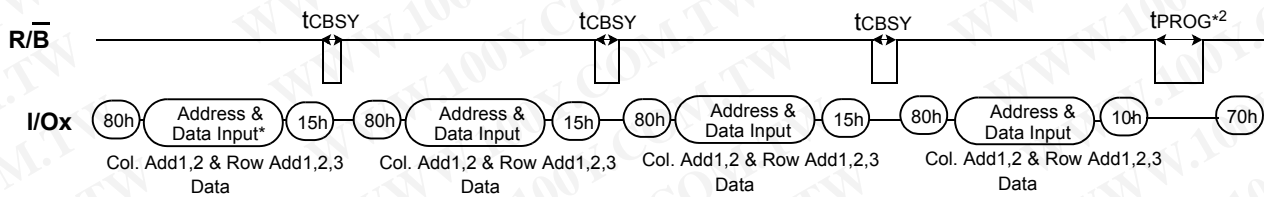

- NOTES :**
1. Cache Read operation is available only within a block.
 2. Since programming the last page does not employ caching, the program time has to be that of Page Program. However, if the previous program cycle with the cache data has not finished, the actual program cycle of the last page is initiated only after completion of the previous cycle, which can be expressed as the following formula.

$$t_{PROG} = \text{Program time for the last page} + \text{Program time for the (last - 1)^{th} \text{ page}} - (\text{Program command cycle time} + \text{Last page data loading time})$$

Figure 15. Cache Program(2/2)

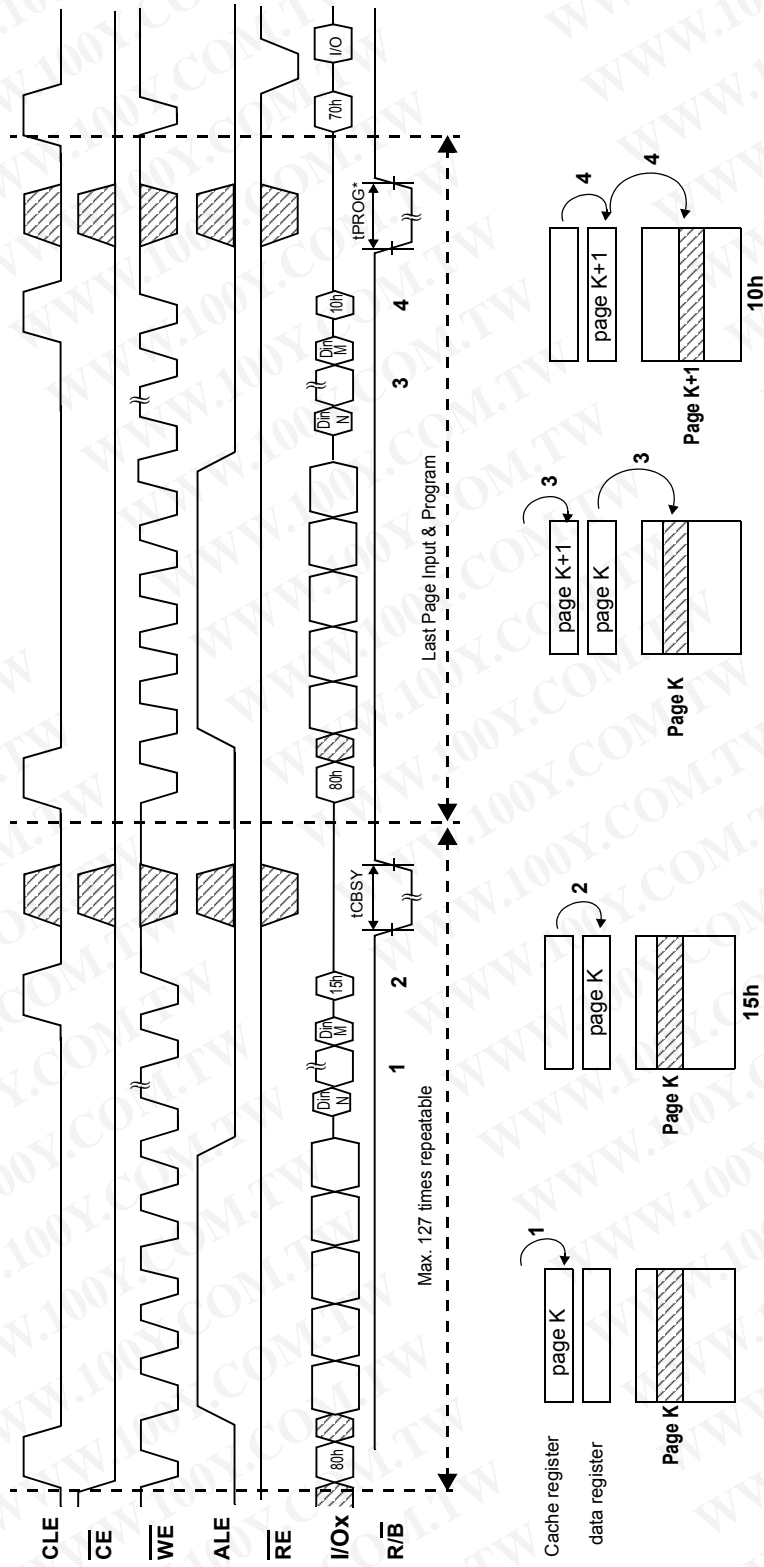

NOTE

- Issuing the 15h command to the device after serial data input initiates the program operation with cache registers.

1. Data for Page K is input to cache registers.

2. Data is transferred to the data registers while the Ready/Busy outputs Busy State (tCBSY).

3. Data for Page K+1 is input to cache registers while the data of the Page K is being programmed.

4. The programming with cache registers is terminated by the 10h command. When the device becomes Ready, it shows that the internal programming of the Page K+1 is completed.

tPROG* = Program time for the last page + Program time for the (last - 1)th page - (command input cycle time + address input cycle time + Last page data loading time)

Pass/Fail status for each page programmed by the Cache Program operation can be detected by the Read Status operation.

- I/O 0 : Pass/Fail of the current page program operation.
 - I/O 1 : Pass/Fail of the previous page program operation.
- The Pass/Fail status on I/O 0 and I/O 1 are valid under the following conditions.
- Status on I/O 0 : True Ready/Busy is Ready state.
 - The True Ready/Busy is output on I/O 5 by Read Status operation or R/B pin after the 10h command.
 - Status on I/O 1 : Cache Read/Busy is Ready State.
 - The Cache Ready/Busy is output on I/O 6 by Read Status operation or R/B pin after the 15h command.

Example)

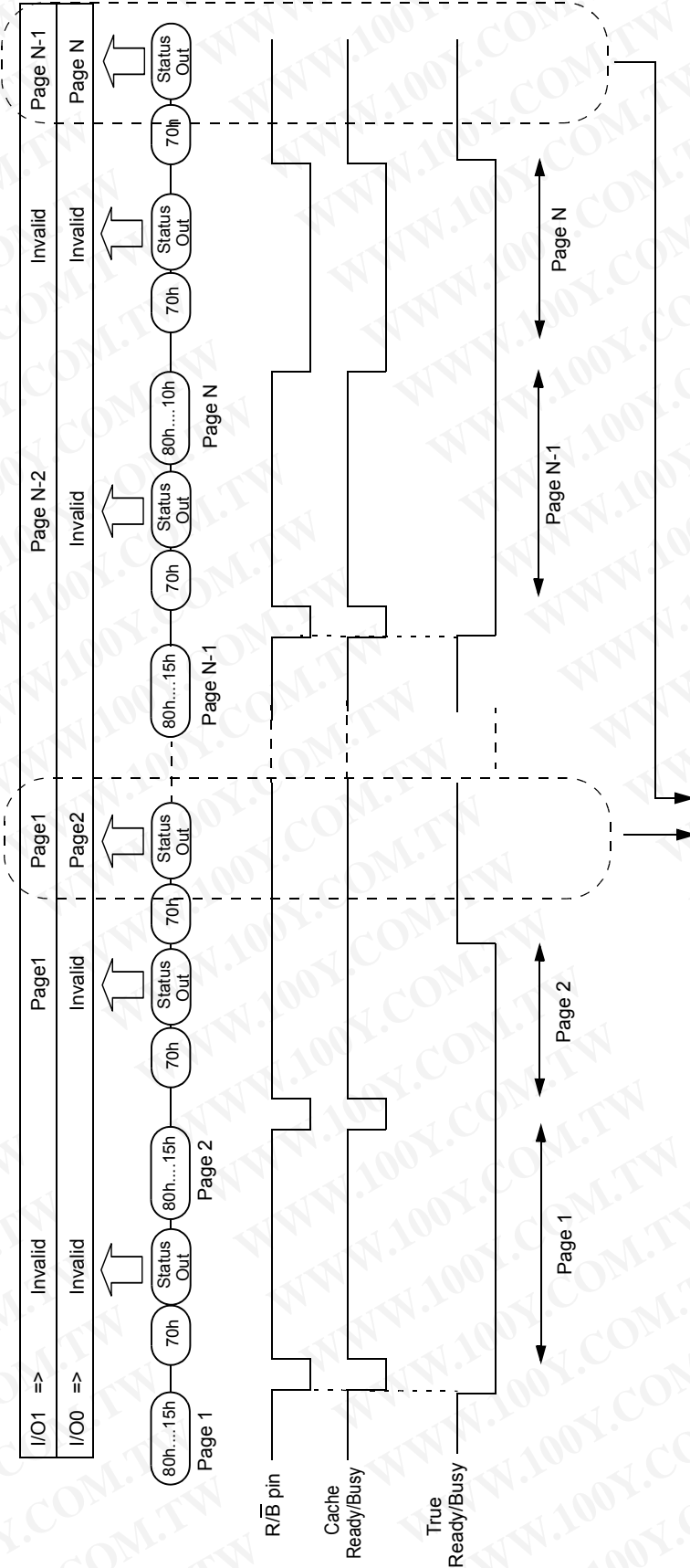

During both True Ready/Busy and Cache Ready/Busy return to Ready state, the Pass/Fail for previous page and current page can be shown through I/O 1 and I/O 0 concurrently.

TWO-PLANE PAGE PROGRAM

Two-Plane Page Program is an extension of Page Program, for a single plane with 4,314 byte data registers. Since the device is equipped with two memory planes, activating the two sets of 4,314 byte data registers enables a simultaneous programming of two pages.

After writing the first set of data up to 4,314 byte into the selected data registers via cache registers, Dummy Page Program command (11h) instead of actual Page Program command (10h) is inputted to finish data-loading of the first plane. Since no programming process is involved, R/B remains in Busy state for a short period of time(tDBSY). Read Status command (70h) may be issued to find out when the device returns to Ready state by polling the Ready/Busy status bit(I/O 6). Then the next set of data for the other plane is inputted after the 81h command and address sequences. After inputting data for the last plane, actual True Page Program(10h) instead of dummy Page Program command (11h) must be followed to start the programming process. The operation of R/B and Read Status is the same as that of Page Program. Although two planes are programmed simultaneously, pass/fail is not available for each page when the program operation completes. Status bit of I/O 0 is set to "1" when any of the pages fails. Restriction in addressing with Two-Plane Page Program is shown is Figure 16.

Figure 16. Two-Plane Page Program

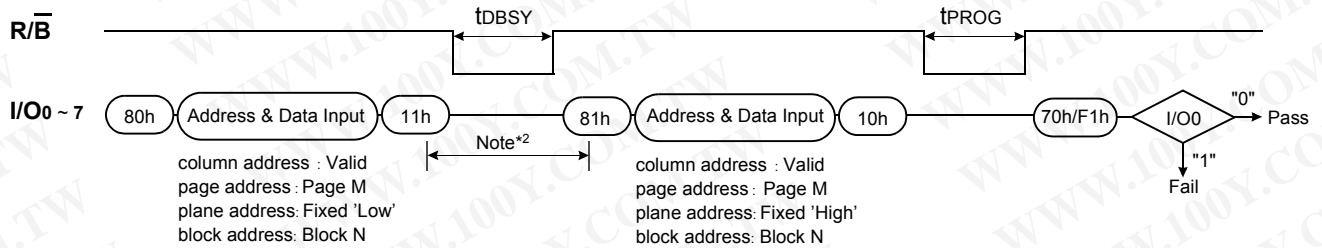

NOTE : 1. It is noticeable that same row address except for A₂₀ is applied to the two blocks
 2. Any command between 11h and 81h is prohibited except 70h/F1h and FFh.

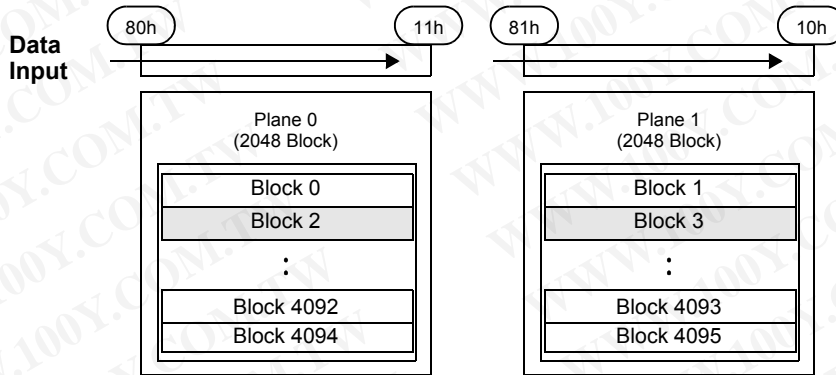

TWO-PLANE COPY-BACK PROGRAM

Two-Plane Copy-Back Program is an extension of Copy-Back Program, for a single plane with 4314 byte data registers. Since the device is equipped with two memory planes, activating the two sets of 4314 byte data registers enables a simultaneous programming of two pages.

Figure 17. Two-Plane Copy-Back Program Operation

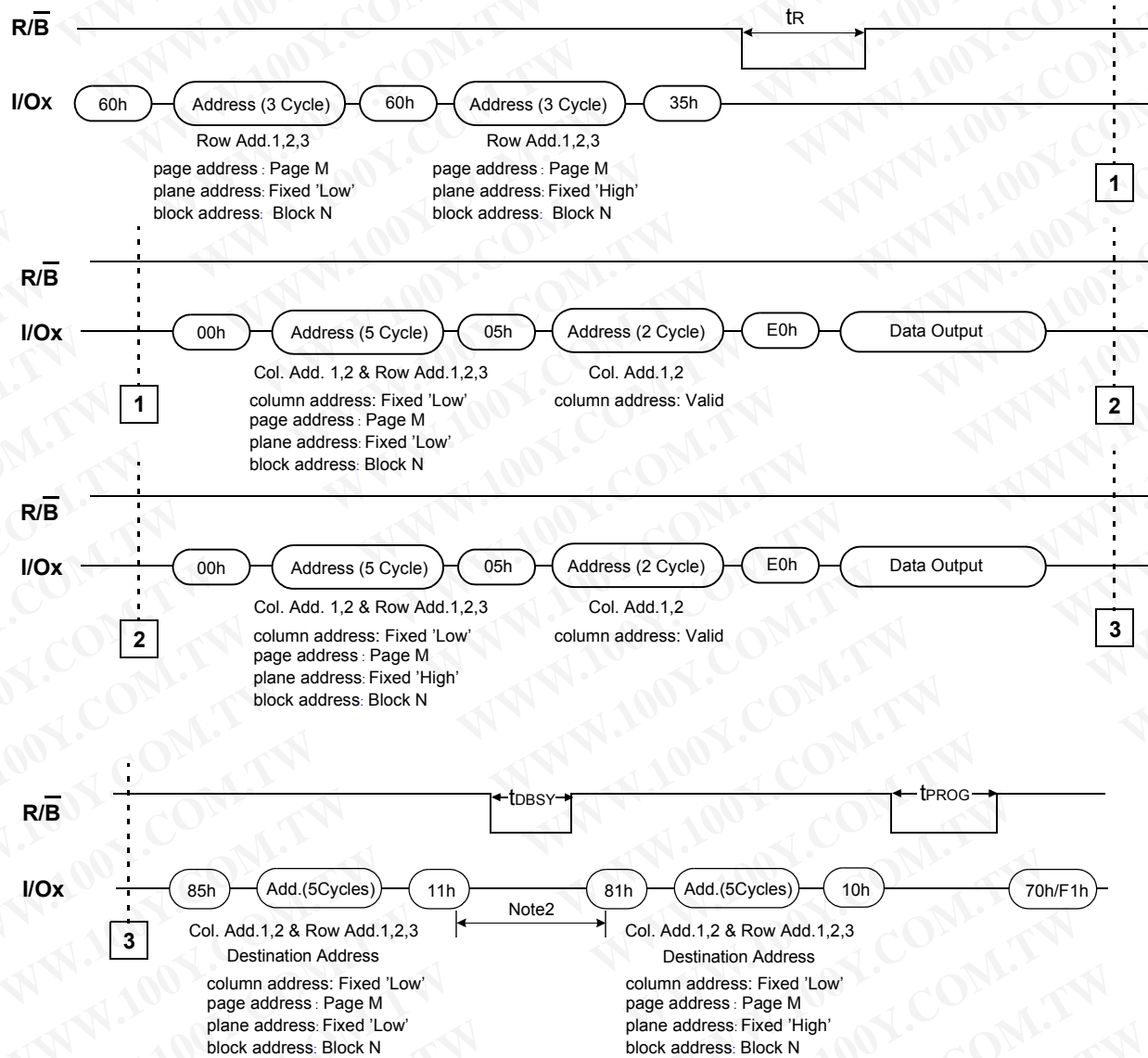

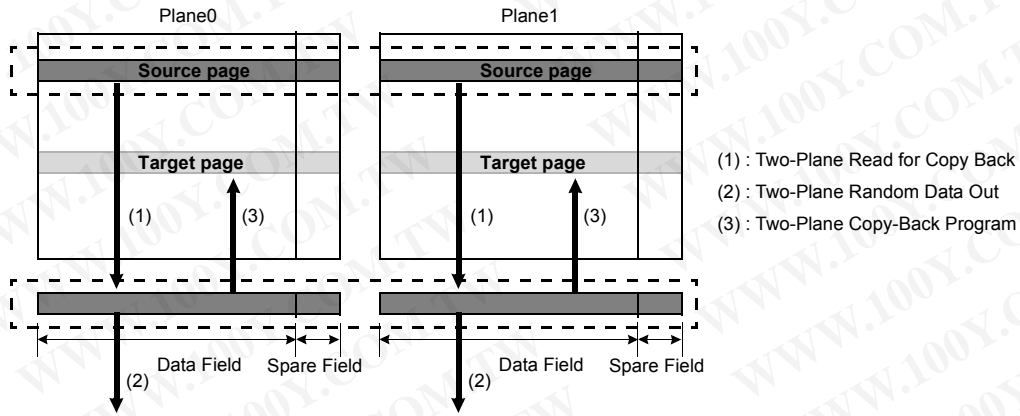

Note: 1. Copy-Back Program operation is allowed only within the same memory plane.
 2. Any command between 11h and 81h is prohibited except 70h/F1h and FFh.

Figure 18. Two-Plane Copy-Back Program Operation with Random Data Input

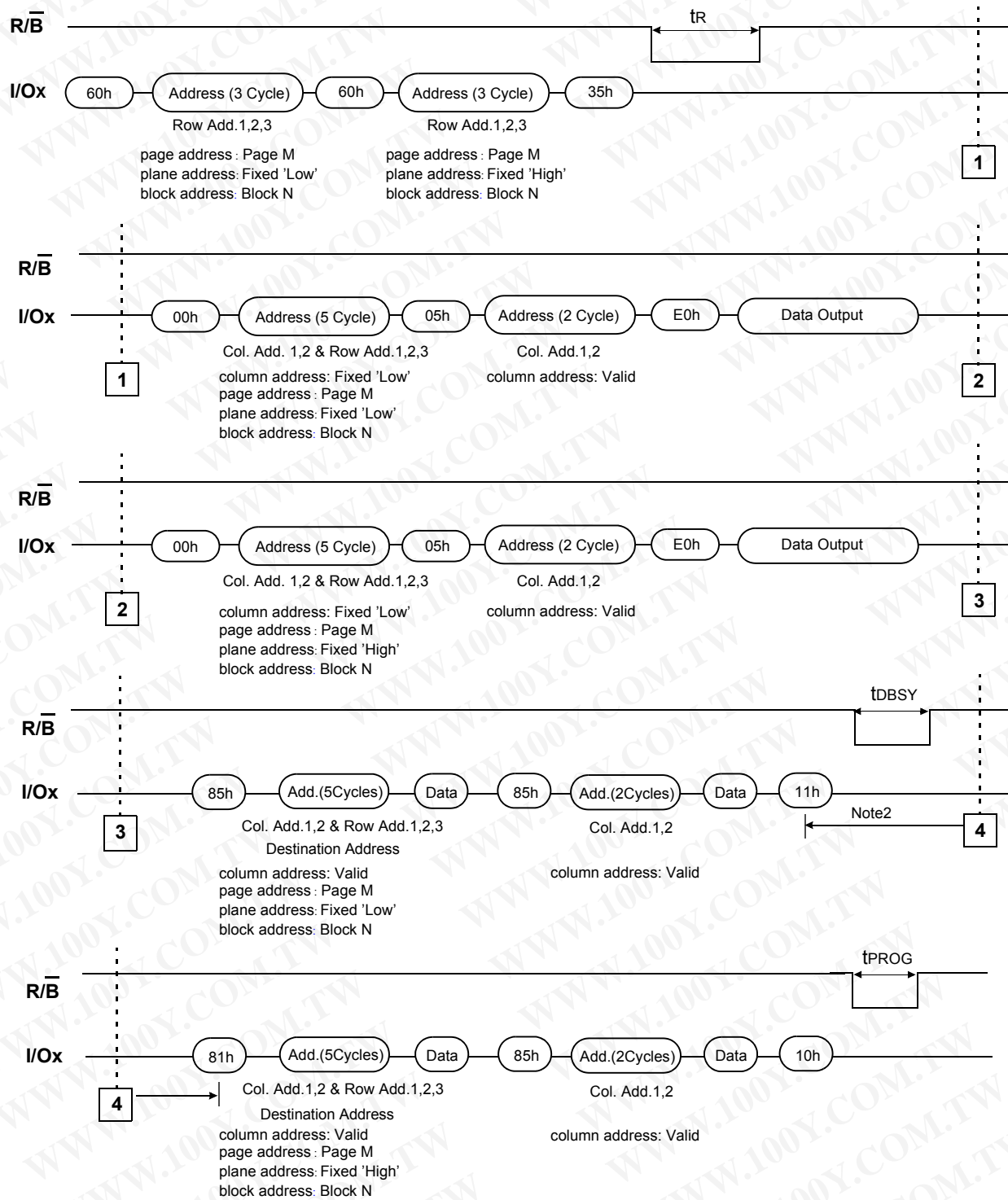

Note: 1. Copy-Back Program operation is allowed only within the same memory plane.
 2. Any command between 11h and 81h is prohibited except 70h/F1h and FFh.

TWO-PLANE CACHE PROGRAM

Two-Plane Cache Program is an extension of Cache Program, for a single plane with 4,314 byte data registers. Since the device is equipped with two memory planes, activating the two sets of 4,314 byte data registers enables a simultaneous programming of two pages.

Figure 19. Two-Plane Cache Program Operation

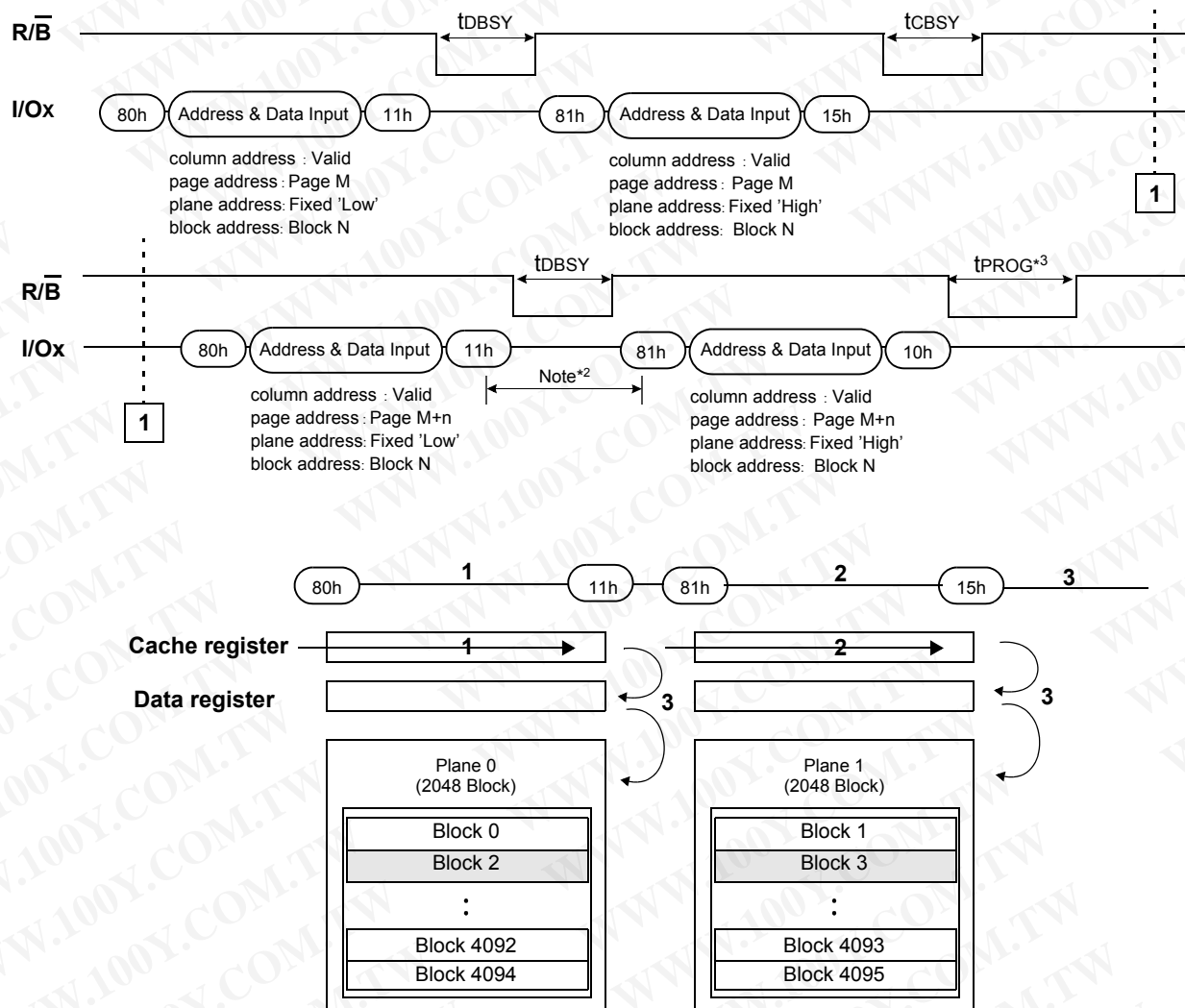

- NOTE :**
1. It is noticeable that same row address except for A20 is applied to the two blocks
 2. Any command between 11h and 81h is prohibited except 70h/F1h and FFh.
 3. Since programming the last page does not employ caching, the program time has to be that of Page Program. However, if the previous program cycle with the cache data has not finished, the actual program cycle of the last page is initiated only after completion of the previous cycle, which can be expressed as the following formula.

$$t_{PROG} = \text{Program time for the last page} + \text{Program time for the (last - 1)^{th} page} - (\text{Program command cycle time} + \text{Last page data loading time})$$

BLOCK ERASE

The Erase operation is done on a block basis. Block address loading is accomplished in three cycles initiated by an Erase Setup command(60h). Only Plane address and Block address are valid while Page address is ignored. The Erase Confirm command(D0h) following the block address loading initiates the internal erasing process. This two-step sequence of setup followed by execution command ensures that memory contents are not accidentally erased due to external noise conditions. At the rising edge of \overline{WE} after the erase confirm command input, the internal write controller handles erase and erase-verify. When the erase operation is completed, the Write Status Bit(I/O 0) may be checked. Figure 20 details the sequence.

Figure 20. Block Erase Operation

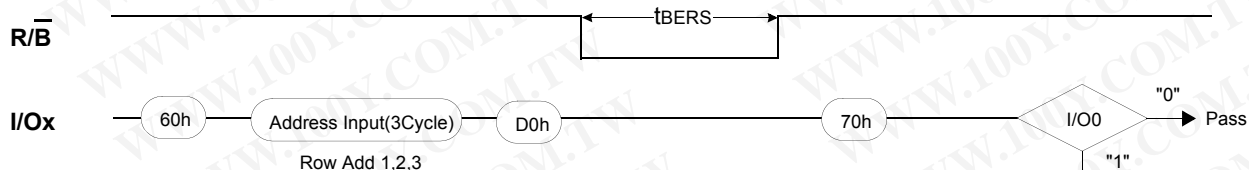

TWO-PLANE BLOCK ERASE

Basic concept of Two-Plane Block Erase operation is identical to that of Two-Plane Page Program. Up to two blocks, one from each plane can be simultaneously erased. Standard Block Erase command sequences (Block Erase Setup command(60h) followed by three address cycles) may be repeated up to twice for erasing up to two blocks. Only one block should be selected from each plane. The Erase Confirm command(D0h) initiates the actual erasing process. The completion is detected by monitoring R/B pin or Ready/ Busy status bit (I/O 6).

Figure 21. Two-Plane Block Erase Operation

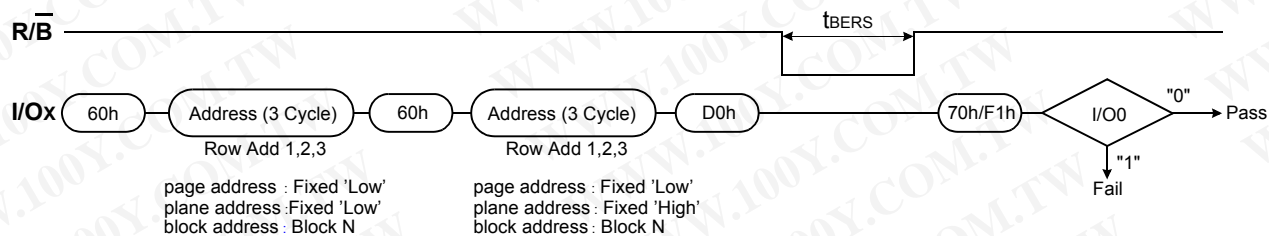

READ STATUS

The device contains a Status Register which may be read to find out whether program or erase operation is completed, and whether the program or erase operation is completed successfully. After writing 70h or F1h command to the command register, a read cycle outputs the content of the Status Register to the I/O pins on the falling edge of \overline{CE} or \overline{RE} , whichever occurs last. This two line control allows the system to poll the progress of each device in multiple memory connections even when R/\overline{B} pins are common-wired. \overline{RE} or \overline{CE} does not need to be toggled for updated status. Refer to Table 2 for specific 70h Status Register definitions and Table 3 for specific F1h status Register definitions. The command register remains in Status Read mode until further commands are issued to it. Therefore, if the status register is read during a random read cycle, the read command(00h) should be given before starting read cycles.

Table 2. Status Register Definition for 70h Command

I/O	Page Program	Block Erase	Cache Program	Read	Cache Read	Definition	
I/O 0	Pass/Fail	Pass/Fail	Pass/Fail(N)	Not Use	Not Use	Pass : "0"	Fail : "1"
I/O 1	Not Use	Not Use	Pass/Fail(N-1)	Not Use	Not Use	Pass : "0"	Fail : "1"
I/O 2	Not Use	Not Use	Not Use	Not Use	Not Use	Don't -cared	
I/O 3	Not Use	Not Use	Not Use	Not Use	Not Use	Don't -cared	
I/O 4	Not Use	Not Use	Not Use	Not Use	Not Use	Don't -cared	
I/O 5	Not Use	Not Use	True Ready/Busy	Not Use	True Ready/Busy	Busy : "0"	Ready : "1"
I/O 6	Ready/Busy	Ready/Busy	Cache Ready/Busy	Ready/Busy	Cache Ready/Busy	Busy : "0"	Ready : "1"
I/O 7	Write Protect	Write Protect	Write Protect	Write Protect	Write Protect	Protected : "0"	Not Protected : "1"

NOTE : 1. I/Os defined 'Not use' are recommended to be masked out when Read Status is being executed.
 2. N : current page, N-1: previous page.

Table 3. F1h Read Status Register Definition

I/O	Page Program	Block Erase	Cache Program	Read	Cache Read	Definition	
I/O 0	Chip Pass/Fail	Chip Pass/Fail	Chip Pass/Fail(N)	Not Use	Not Use	Pass : "0"	Fail : "1"
I/O 1	Plane0 Pass/Fail	Plane0 Pass/Fail	Plane0 Pass/Fail(N)	Not Use	Not Use	Pass : "0"	Fail : "1"
I/O 2	Plane1 Pass/Fail	Plane1 Pass/Fail	Plane1 Pass/Fail(N)	Not Use	Not Use	Pass : "0"	Fail : "1"
I/O 3	Not Use	Not Use	Plane0 Pass/Fail(N-1)	Not Use	Not Use	Pass : "0"	Fail : "1"
I/O 4	Not Use	Not Use	Plane1 Pass/Fail(N-1)	Not Use	Not Use	Pass : "0"	Fail : "1"
I/O 5	Not Use	Not Use	True Ready/Busy	Not Use	True Ready/Busy	Busy : "0"	Ready : "1"
I/O 6	Ready/Busy	Ready/Busy	Cache Ready/Busy	Ready/Busy	Cache Ready/Busy	Busy : "0"	Ready : "1"
I/O 7	Write Protect	Write Protect	Write Protect	Write Protect	Write Protect	Protected : "0"	Not Protected : "1"

NOTE : 1. I/Os defined 'Not use' are recommended to be masked out when Read Status is being executed.
 2. N : current page, N-1 : previous page.

Read ID

The device contains a product identification mode, initiated by writing 90h to the command register, followed by an address input of 00h. Six read cycles sequentially output the manufacturer code(ECh), the device code, 3rd, 4th, 5th and 6th cycle ID respectively. The command register remains in Read ID mode until further commands are issued to it. Figure 22 shows the operation sequence.

Figure 22. Read ID Operation

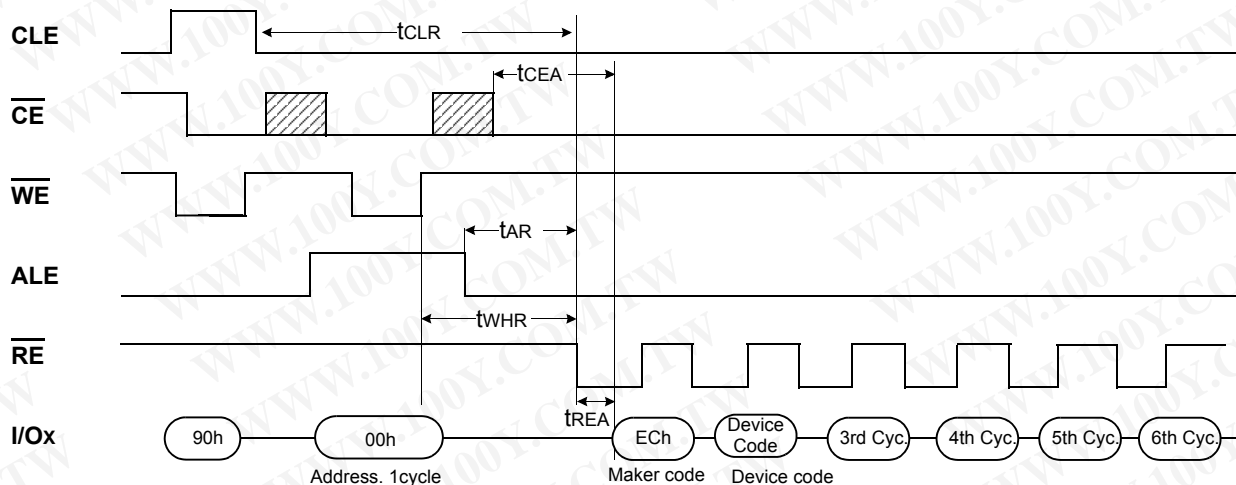

Device	Device Code (2nd Cycle)	3rd Cycle	4th Cycle	5th Cycle	6th Cycle
K9GAG08B0D	Same as K9GAG08U0D				
K9GAG08U0D	D5h	94h	29h	34h	41h
K9LBG08U1D	Same as K9GAG08U0D in it				
K9HCG08U5D	Same as K9GAG08U0D in it				

RESET

The device offers a reset feature, executed by writing FFh to the command register. When the device is in Busy state during random read, program or erase mode, the reset operation will abort these operations. The contents of memory cells being altered are no longer valid, as the data will be partially programmed or erased. The command register is cleared to wait for the next command, and the Status Register is cleared to value C0h when WP is high. Refer to Table 4 for device status after reset operation. If the device is already in reset state a new reset command will be accepted by the command register. The R/B pin changes to low for tRST after the Reset command is written. Refer to Figure 23 below.

Figure 23. RESET Operation

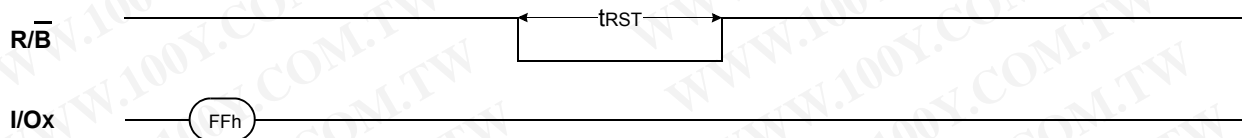

Table 4. Device Status

	After Power-up	After Reset
Operation mode	00h Command is latched	Waiting for next command

Table 5. Paired Page Address Information

Paired Page Address		Paired Page Address	
00h	04h	01h	05h
02h	08h	03h	09h
06h	0Ch	07h	0Dh
0Ah	10h	0Bh	11h
0Eh	14h	0Fh	15h
12h	18h	13h	19h
16h	1Ch	17h	1Dh
1Ah	20h	1Bh	21h
1Eh	24h	1Fh	25h
22h	28h	23h	29h
26h	2Ch	27h	2Dh
2Ah	30h	2Bh	31h
2Eh	34h	2Fh	35h
32h	38h	33h	39h
36h	3Ch	37h	3Dh
3Ah	40h	3Bh	41h
3Eh	44h	3Fh	45h
42h	48h	43h	49h
46h	4Ch	47h	4Dh
4Ah	50h	4Bh	51h
4Eh	54h	4Fh	55h
52h	58h	53h	59h
56h	5Ch	57h	5Dh
5Ah	60h	5Bh	61h
5Eh	64h	5Fh	65h
62h	68h	63h	69h
66h	6Ch	67h	6Dh
6Ah	70h	6Bh	71h
6Eh	74h	6Fh	75h
72h	78h	73h	79h
76h	7Ch	77h	7Dh
7Ah	7Eh	7Bh	7Fh

Note: When program operation is abnormally aborted (ex. power-down, reset), not only page data under program but also paired page data may be damaged(Table 5).

READY/BUSY

The device has a $\overline{R/B}$ output that provides a hardware method of indicating the completion of a page program, erase and random read completion. The $\overline{R/B}$ pin is normally high but transitions to low after program or erase command is written to the command register or random read is started after address loading. It returns to high when the internal controller has finished the operation. The pin is an open-drain driver thereby allowing two or more $\overline{R/B}$ outputs to be Or-tied. Because pull-up resistor value is related to $t_r(\overline{R/B})$ and current drain during busy(i_{busy}), an appropriate value can be obtained with the following reference chart(Fig.24). Its value can be determined by the following guidance.

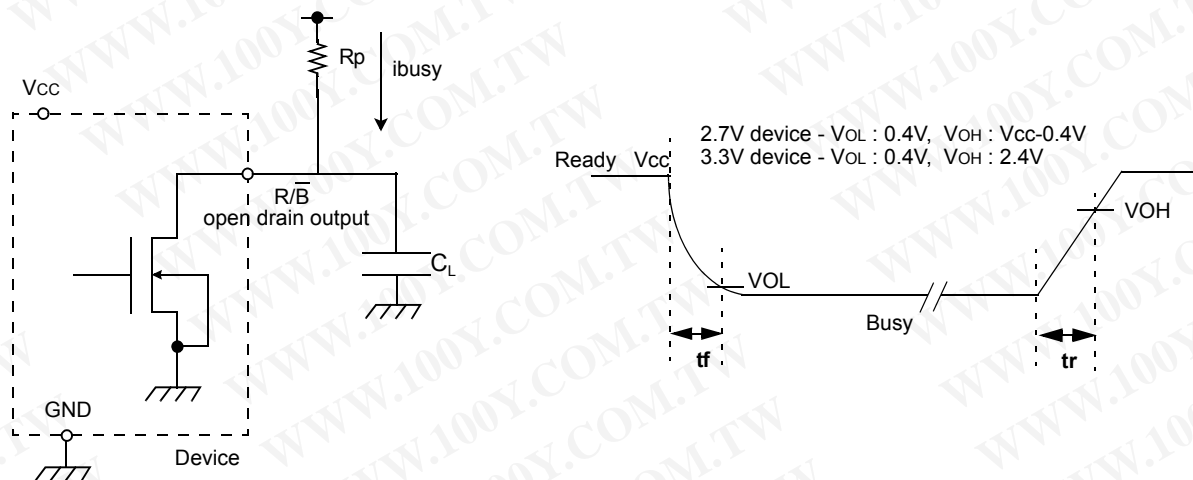
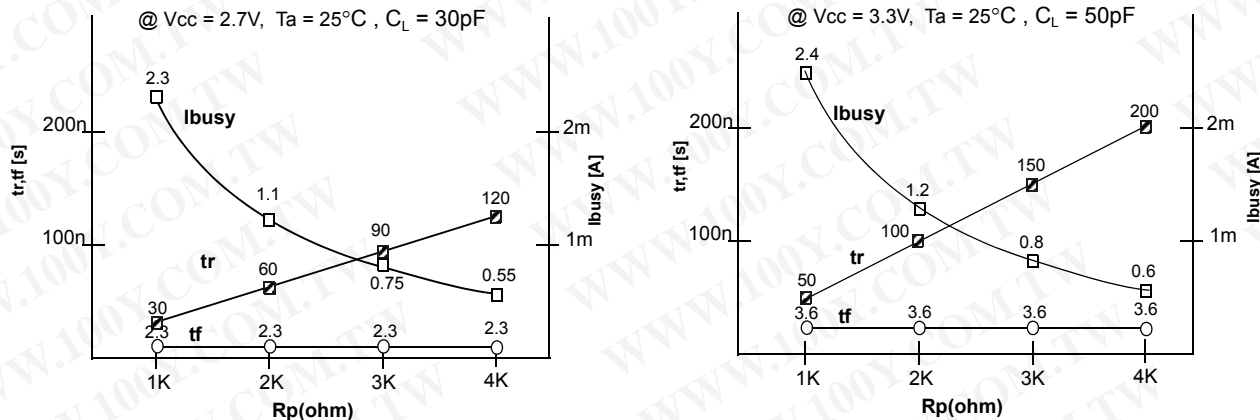

Figure 24. R_p vs t_r, t_f & R_p vs i_{busy}



Rp value guidance

$$R_p(\min, 2.7V \text{ part}) = \frac{V_{cc}(\text{Max.}) - V_{OL}(\text{Max.})}{I_{OL} + \sum I_L} = \frac{2.5V}{3mA + \sum I_L}$$

$$R_p(\min, 3.3V \text{ part}) = \frac{V_{cc}(\text{Max.}) - V_{OL}(\text{Max.})}{I_{OL} + \sum I_L} = \frac{3.2V}{8mA + \sum I_L}$$

where I_L is the sum of the input currents of all devices tied to the $\overline{R/B}$ pin.
 $R_p(\max)$ is determined by maximum permissible limit of t_r

DATA PROTECTION & POWER UP SEQUENCE

The device internal initialization starts after the power supply reaches an appropriate level in the power on sequence. During the initialization the device Ready/Busy signal indicates the Busy state as shown in the figure 25. In this time period, the acceptable command is 70h(F1h).

The device is designed to offer protection from any involuntary program/erase during power-transitions. An internal voltage detector disables all functions whenever Vcc is below about 1.8V(2.7V device), 2V(3.3V device). WP pin provides hardware protection and is recommended to be kept at VIL during power-up and power-down. The two step command sequence for program/erase provides additional software protection.

Figure 25. AC Waveforms for Power Transition

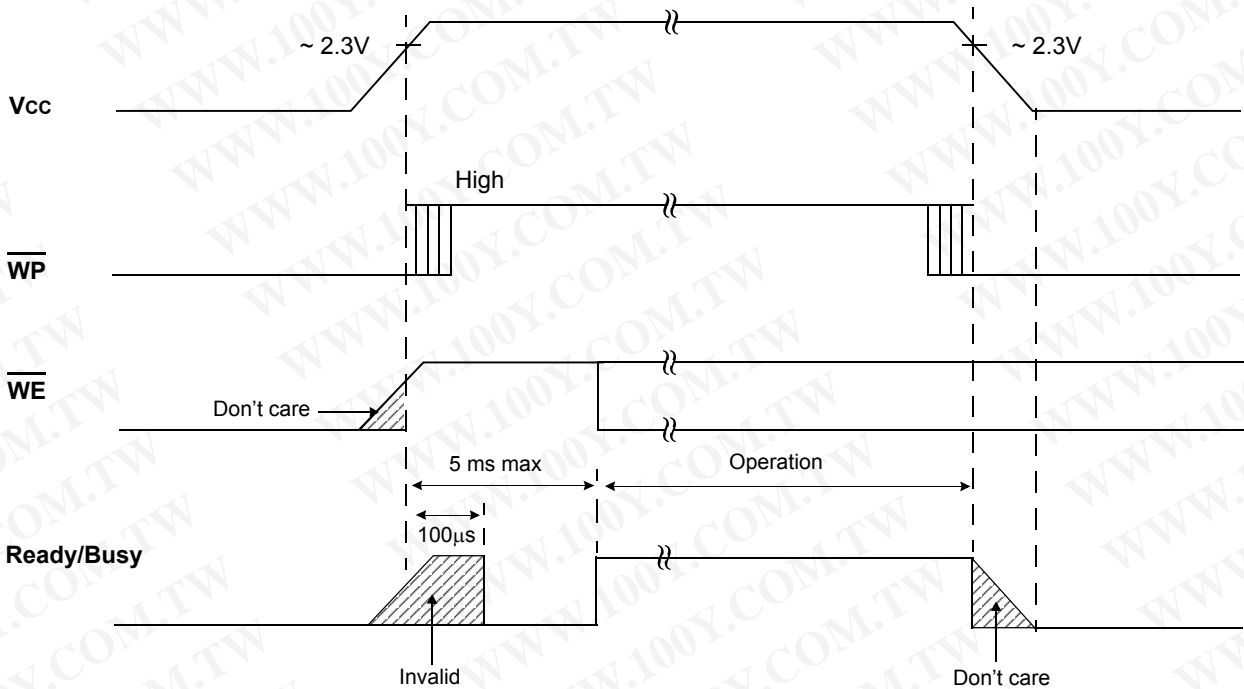

Note : During the initialization, the device consumes a maximum current of 30mA (Icc1)

WP AC Timing guide

Enabling \overline{WP} during erase and program busy is prohibited. The erase and program operations are enabled and disabled as follows:

Figure B-1. Program Operation

1. Enable Mode

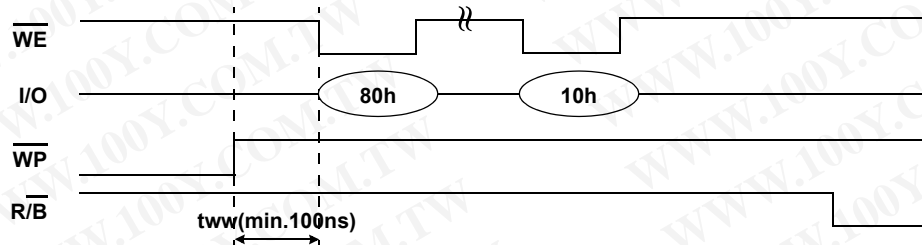

2. Disable Mode

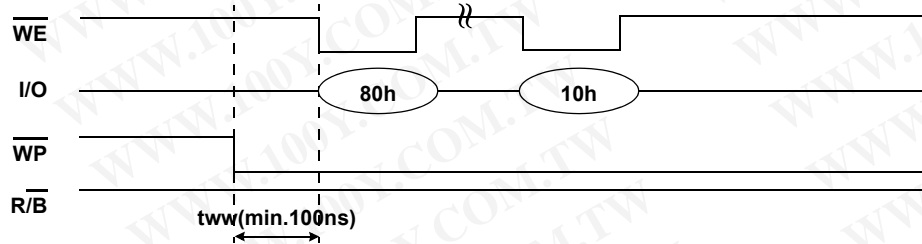
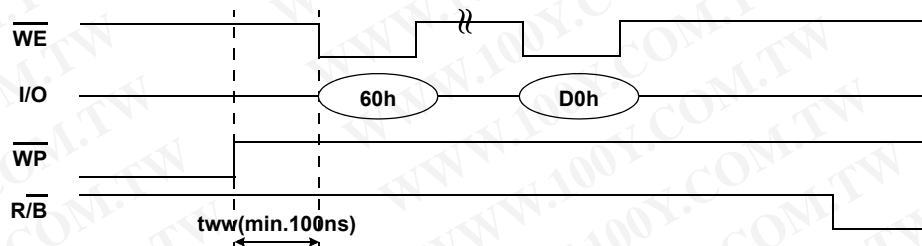

Figure B-2. Erase Operation

1. Enable Mode



2. Disable Mode

