



# HJ31C

NPN EPITAXIAL PLANAR TRANSISTOR

## Description

The HJ31C is designed for use in general purpose amplifier and switching applications.

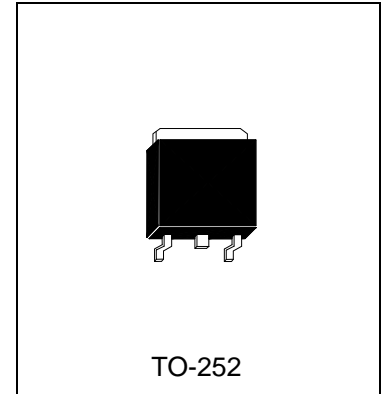

## Absolute Maximum Ratings (T<sub>A</sub>=25°C)

- Maximum Temperatures
  - Storage Temperature ..... -55 ~ +150 °C
  - Junction Temperature ..... +150 °C
- Maximum Power Dissipation
  - Total Power Dissipation (T<sub>C</sub>=25°C) ..... 15W
- Maximum Voltages and Currents
  - BV<sub>CBO</sub> Collector to Base Voltage ..... 100 V
  - BV<sub>CEO</sub> Collector to Emitter Voltage ..... 100 V
  - BV<sub>EBO</sub> Emitter to Base Voltage ..... 5 V
  - I<sub>C</sub> Collector Current ..... 3 A

## Electrical Characteristics (T<sub>A</sub>=25°C)

Symbol	Min.	Typ.	Max.	Unit	Test Conditions
BV <sub>CBO</sub>	100	-	-	V	I <sub>C</sub> =1mA, I <sub>E</sub> =0
BV <sub>CEO</sub>	100	-	-	V	I <sub>C</sub> =30mA, I <sub>B</sub> =0
I <sub>CES</sub>	-	-	20	uA	V <sub>CE</sub> =100V, V <sub>EB</sub> =0
I <sub>CEO</sub>	-	-	50	uA	V <sub>CE</sub> =60V, I <sub>B</sub> =0
I <sub>EBO</sub>	-	-	1	mA	V <sub>EB</sub> =5V, I <sub>C</sub> =0
*V <sub>CE(sat)</sub>	-	-	1.2	V	I <sub>C</sub> =3A, I <sub>B</sub> =375mA
*V <sub>BE(on)</sub>	-	-	1.8	V	V <sub>CE</sub> =4V, I <sub>C</sub> =3A
*h <sub>FE1</sub>	25	-	-		V <sub>CE</sub> =4V, I <sub>C</sub> =1A
*h <sub>FE2</sub>	10	-	50		V <sub>CE</sub> =4V, I <sub>C</sub> =3A
f <sub>T</sub>	3	-	-	MHz	V <sub>CE</sub> =10V, I <sub>C</sub> =500mA, f=1MHz

\*Pulse Test: Pulse Width ≤380us, Duty Cycle ≤2%



### Characteristics Curve

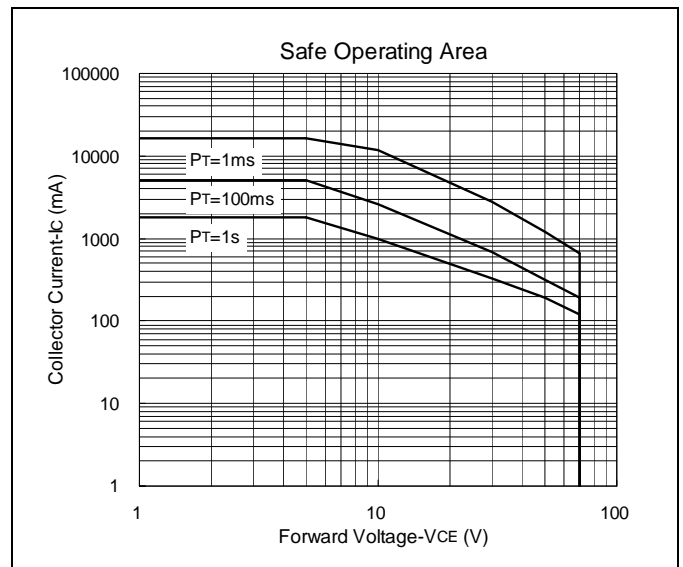
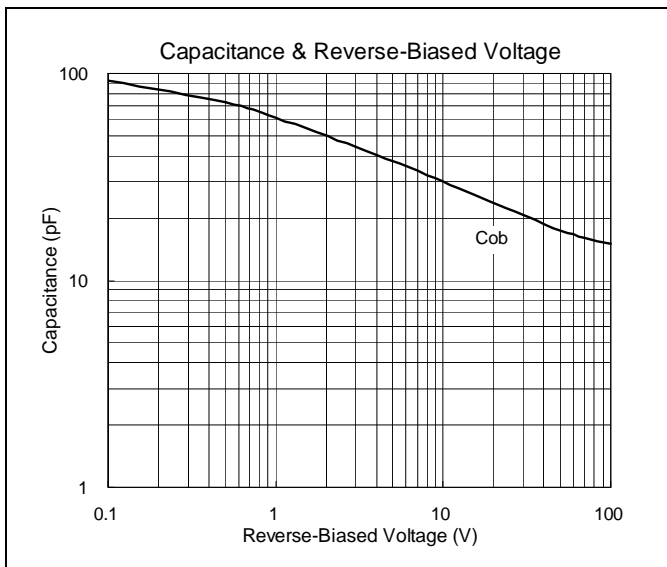
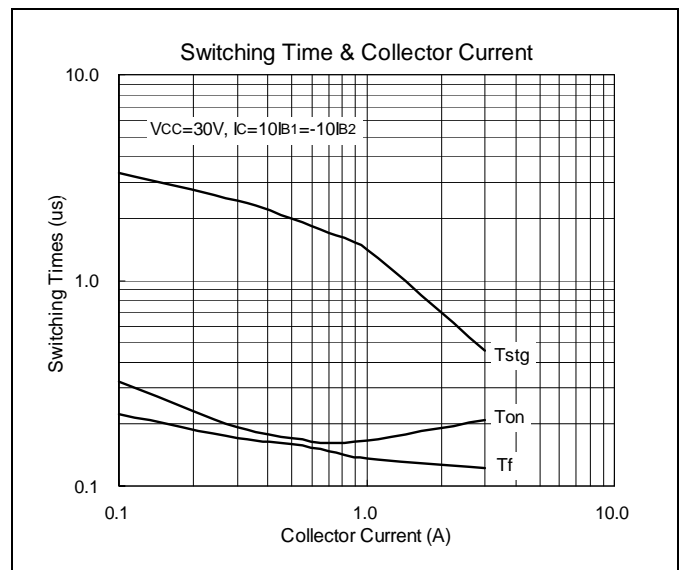
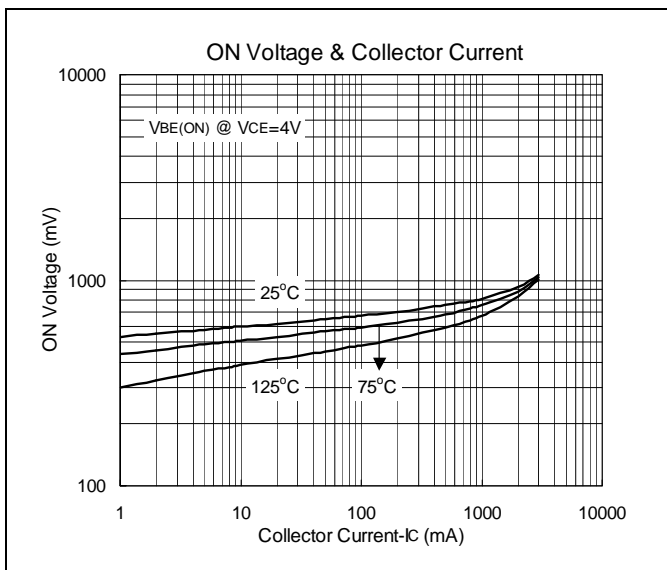
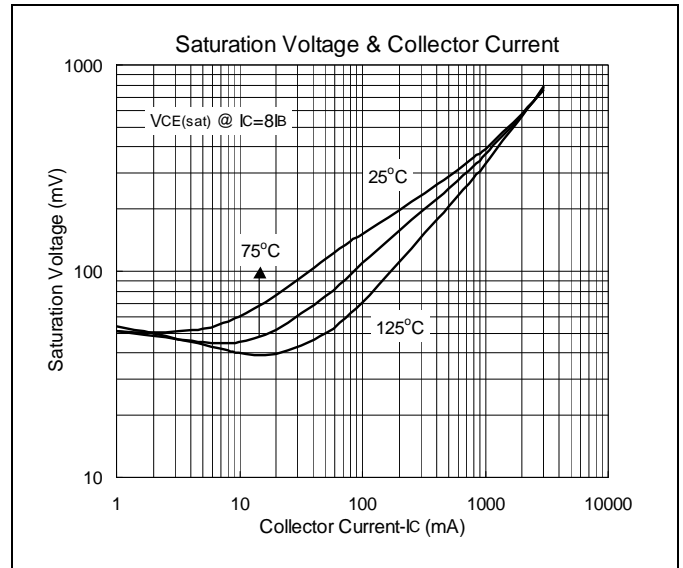
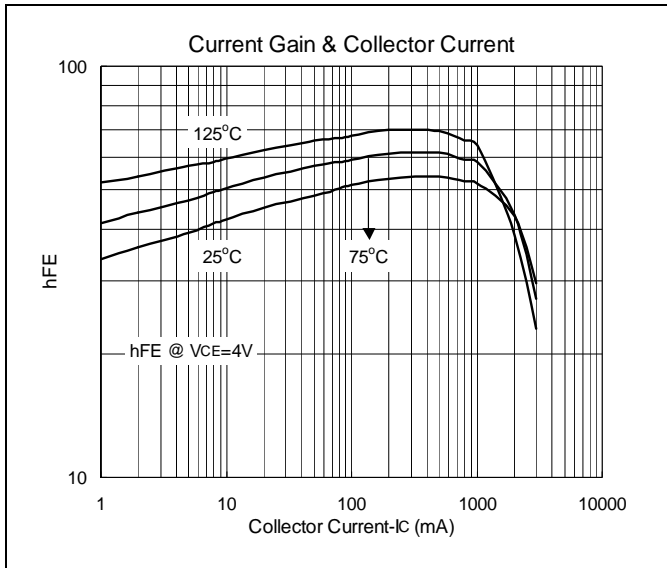



### TO-252 Dimension

3-Lead TO-252 Plastic  
Surface Mount Package  
HSMC Package Code: J

**Marking:**

Pb Free Mark  
 Pb-Free: "●" (Note)  
 Normal: None

Date Code      Control Code

Note: Green label is used for pb-free packing  
 Pin Style: 1.Base 2.Collector 3.Emitter

**Material:**

- Lead solder plating: Sn60/Pb40 (Normal), Sn/3.0Ag/0.5Cu or Pure-Tin (Pb-free)
- Mold Compound: Epoxy resin family, flammability solid burning class: UL94V-0

DIM	Min.	Max.
A	6.35	6.80
C	4.80	5.50
F	1.30	1.70
G	5.40	6.25
H	2.20	3.00
L	0.40	0.90
M	2.20	2.40
N	0.90	1.50
a1	0.40	0.65
a2	-	*2.30
a5	0.65	1.05

\*: Typical, Unit: mm

3-Lead TO-252 Plastic  
Surface Mount Package  
HSMC Package Code: J

**Marking:**

Pb Free Mark  
 Pb-Free: "●" (Note)  
 Normal: None

Date Code      Control Code

Note: Green label is used for pb-free packing  
 Pin Style: 1.Base 2.Collector 3.Emitter

**Material:**

- Lead solder plating: Sn60/Pb40 (Normal), Sn/3.0Ag/0.5Cu or Pure-Tin (Pb-free)
- Mold Compound: Epoxy resin family, flammability solid burning class: UL94V-0

DIM	Min.	Max.
A	6.40	6.80
B	-	6.00
C	5.04	5.64
D	-	*4.34
E	0.40	0.80
F	0.50	0.90
G	5.90	6.30
H	2.50	3.20
I	9.20	9.80
J	0.60	1.00
K	-	0.96
L	0.66	0.86
M	2.20	2.40
N	0.70	1.10
O	0.82	1.22
a1	0.40	0.60
a2	2.10	2.50
y1	-	5°
y2	-	3°

\*: Typical, Unit: mm

#### Important Notice:

- All rights are reserved. Reproduction in whole or in part is prohibited without the prior written approval of HSMC.
- HSMC reserves the right to make changes to its products without notice.
- **HSMC semiconductor products are not warranted to be suitable for use in Life-Support Applications, or systems.**
- HSMC assumes no liability for any consequence of customer product design, infringement of patents, or application assistance.

#### Head Office And Factory:

- **Head Office** (Hi-Sincerity Microelectronics Corp.): 10F., No. 61, Sec. 2, Chung-Shan N. Rd. Taipei Taiwan R.O.C.  
 Tel: 886-2-25212056 Fax: 886-2-25632712, 25368454
- **Factory 1:** No. 38, Kuang Fu S. Rd., Fu-Kou Hsin-Chu Industrial Park Hsin-Chu Taiwan. R.O.C  
 Tel: 886-3-5983621~5 Fax: 886-3-5982931



### Soldering Methods for HSMC's Products

1. Storage environment: Temperature=10°C~35°C Humidity=65%±15%
2. Reflow soldering of surface-mount devices

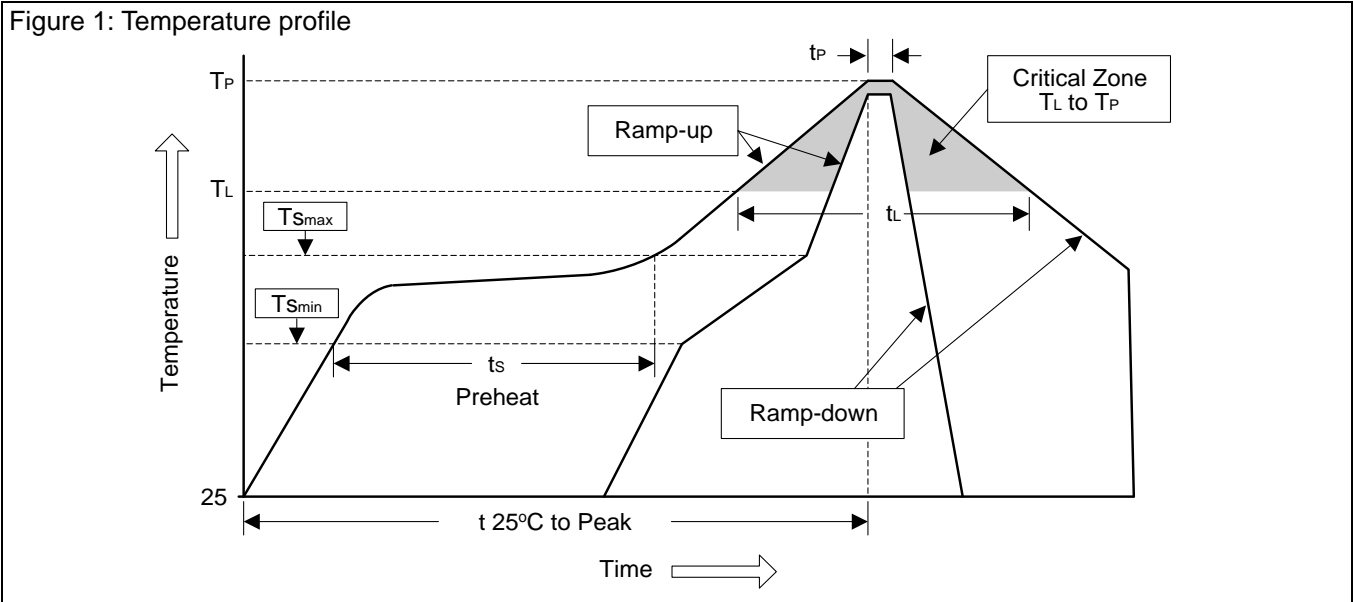

Profile Feature	Sn-Pb Eutectic Assembly	Pb-Free Assembly
Average ramp-up rate ( $T_L$ to $T_P$ )	<3°C/sec	<3°C/sec
Preheat		
- Temperature Min ( $T_{Smin}$ )	100°C	150°C
- Temperature Max ( $T_{Smax}$ )	150°C	200°C
- Time (min to max) ( $t_s$ )	60~120 sec	60~180 sec
$T_{Smax}$ to $T_L$		
- Ramp-up Rate	<3°C/sec	<3°C/sec
Time maintained above:		
- Temperature ( $T_L$ )	183°C	217°C
- Time ( $t_L$ )	60~150 sec	60~150 sec
Peak Temperature ( $T_P$ )	240°C +0/-5°C	260°C +0/-5°C
Time within 5°C of actual Peak Temperature ( $t_P$ )	10~30 sec	20~40 sec
Ramp-down Rate	<6°C/sec	<6°C/sec
Time 25°C to Peak Temperature	<6 minutes	<8 minutes

### 3. Flow (wave) soldering (solder dipping)

Products	Peak temperature	Dipping time
Pb devices.	245°C ±5°C	10sec ±1sec
Pb-Free devices.	260°C ±5°C	10sec ±1sec