

HA1199/HA12417

AM Tuner for Car Radio

The HITACHI HA1199 and HA12417 have been developed as the AM Tuners for car radio. HA1199 is encapsulated in a DIP-16pin, and HA12417 in SIP-16pin (Vertical Plastic Package). These IC's employ the same chips, and their features are as follows.

FEATURES

- Complete 1-chip AM Tuner
- Automatic gain control circuit at RF stage for the better performance under high input
- High AGC FOM (63dB typ.)
- Low distortion (0.4% at 74dB μ input)
- Better beat performance
- Large two-signal selectivity (55dB typ. under desired signal of 54dB μ)
- Standard supply voltage range is 10.8V through 15.6V, and local oscillation stopping voltage is less than 6V.

HA1199



(DP-16)

HA12417



(SP-16)

ABSOLUTE MAXIMUM RATINGS ($T_a = 25^\circ\text{C}$)

Item	Symbol	Rating	Unit
Supply Voltage	V_{CC}	16	V
Power Dissipation*	P_T	550	mW
Operating Temperature	T_{op}	-30 to +70	$^\circ\text{C}$
Storage Temperature	T_{stg}	-55 to +125	$^\circ\text{C}$

* Value at $T_a = 60^\circ\text{C}$

PIN ARRANGEMENT

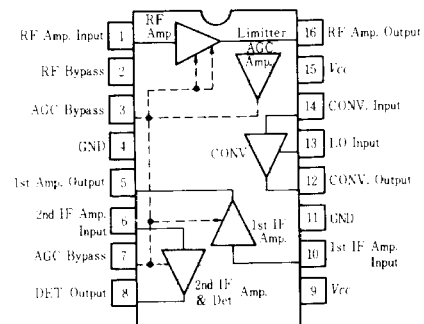

(Top View)

ELECTRICAL CHARACTERISTICS

($V_{CC} = 13.2\text{V}$, $f_c = 1000\text{kHz}$, $f_m = 400\text{Hz}$, Output Power of Power Stage = 0.5W, $R_L = 4\Omega$, and $T_a = 25^\circ\text{C}$ Unless otherwise noted)

Item	Symbol	Test Circuit	Test Condition	min.	typ.	max.	Unit
Current Drain	I_{CC}	1	$V_{CC} = 13.2\text{V}$ at zero signal	—	15	—	mA
Signal-to-noise Ratio	S/N	2	Input = 34dB μ , 30% mod.	25.5	30	—	dB
AGC FOM		2	Output Base at 74dB μ input. Test at the 10dB output down, 30% mod.	51	63	—	dB
Det. Output		2	Input = 74dB μ , V_2 Test, 30% mod.	51	80	127	mV
Distortion	$T.H.D$	2	Input = 114dB μ , 30% mod.	—	0.4	5	%
Sensitivity		2	Input at $S/N = 20\text{dB}$, 30% mod.	—	23	—	dB μ

■ CIRCUIT SCHEMATIC AND STANDARD EXTERNAL APPLICATIONS

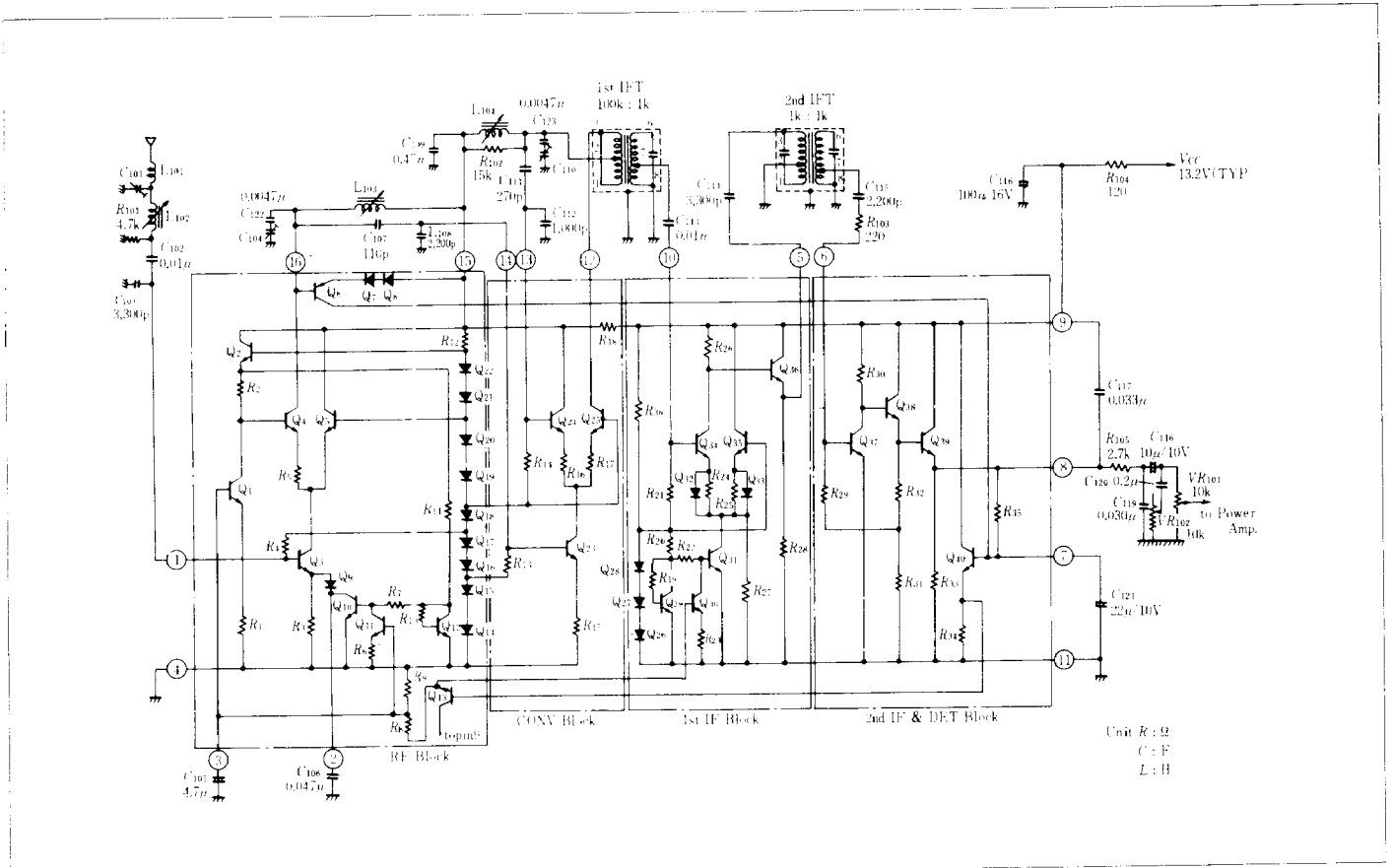

■ EXTERNAL COMPONENTS

Parts No.	Recommended Value	Purpose	Influence		Additional Information
			Larger than Recommended Value	Smaller than Recommended Value	
R ₁₀₂	15kΩ	Dumping of local oscillation coil	Increase of unwanted radiation	Local oscillation stop	
R ₁₀₃	220Ω	Gain adjust for 2nd IF stage	Decrease in gain	Increase in gain. Instability	
R ₁₀₄	120Ω	Decoupling resistor	Drop in supply voltage	Leads to "Motorboating"	
R ₁₀₅	2.7kΩ	Part of detective filter	Decrease in output voltage. Poor frequency response (at higher frequency)	Degradation of S/N	
C ₁₀₂	0.01μF	ANT Tuning circuit	Increase in ANT gain	Decrease in ANT gain	
C ₁₀₃	3300pF		Improvement in usable sensitivity. Decrease of ANT gain	Degradation of usable sensitivity	Increase of ANT gain
C ₁₀₅	4.7μF	AGC Ripple filter & Time constant	Poor AGC response	Degradation of T. H. D at middle- and high-level input	
C ₁₀₆	0.047μF	RF by-passing	Poor cross-modulation characteristics	Poor usable sensitivity	
C ₁₀₇	110pF	RF tuning & coupling	Increase in gain	Decrease in gain	
C ₁₀₈	2200pF	Coupling divider	Decrease in gain	Increase in gain	
C ₁₀₉	0.47μF	Decoupling capacitor		Poor beat characteristics	Good RF characteristics should be required
C ₁₁₂	1000pF	Coupling divider	Stop of local oscillation		
C ₁₁₃	0.01μF	Coupling capacitor		Decrease of gain	
C ₁₁₄	3300pF	Coupling capacitor	Decrease of gain	Decrease of gain	It should be determined by matching to 2nd IFT
C ₁₁₅	2200pF				
C ₁₁₆	100μF	Decoupling capacitor		Leads to "Motorboating"	
C ₁₁₈	0.039μF	Part of detective filter	Poor frequency response (at higher frequency)	Degradation of S/N	
C ₁₂₁	22μF	AGC Ripple filter & Time constant	Poor AGC response	Degradation of T. H. D at low modulation frequency input	
L ₁₀₁	5μH	Prevention of incoming noise	Tracking error	Ineffective	

■ SPECIFICATION OF THE IFT'S

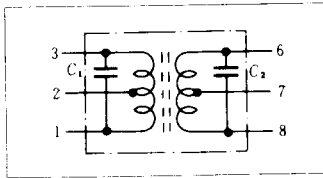

	Q ₀	Number of turns				C ₁ (pF)	C ₂ (pF)	Tuned frequency (kHz)
		1-2	2-3	6-7	7-8			
1st IFT	70	66	220	260	26	180	180	262.5
2nd IFT	70	271	23	271	23	180	180	262.5

■ TEST CIRCUITS

1.

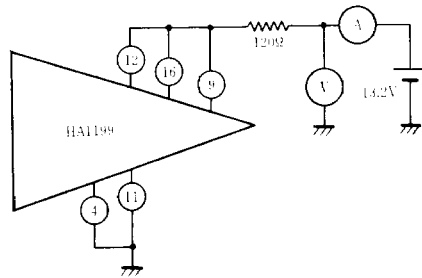

2.

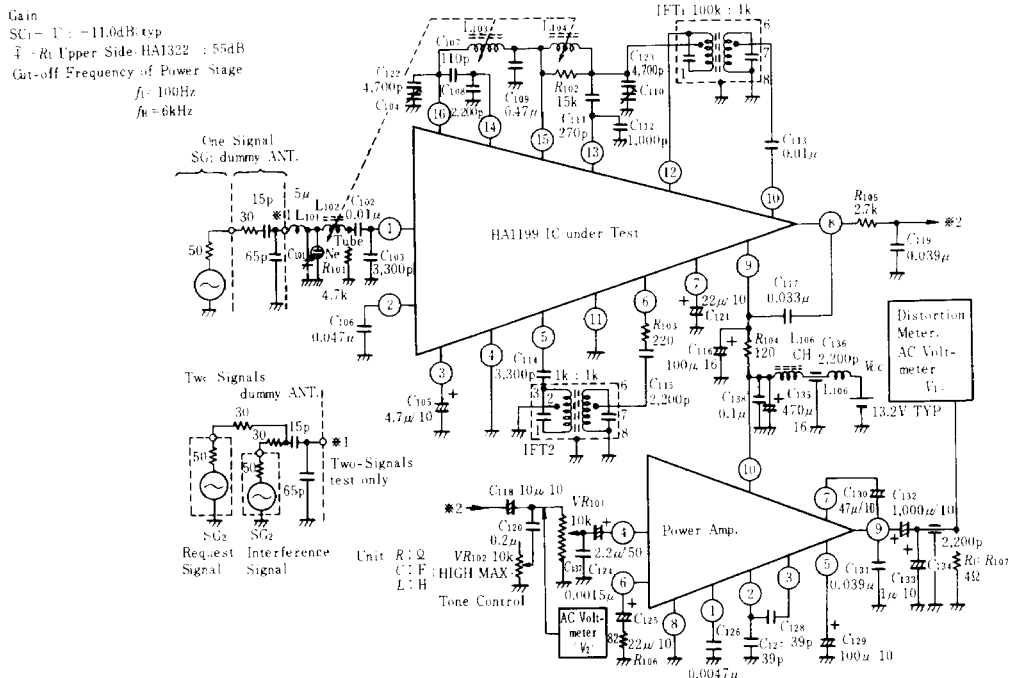

PRINTED CIRCUIT BOARD LAYOUT PATTERN

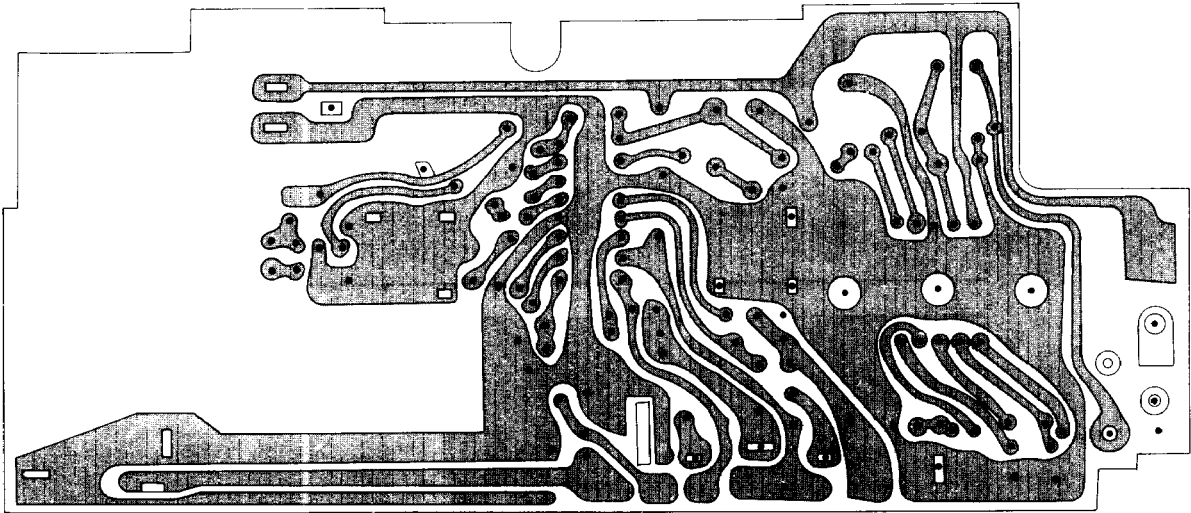

HA1199 Top View

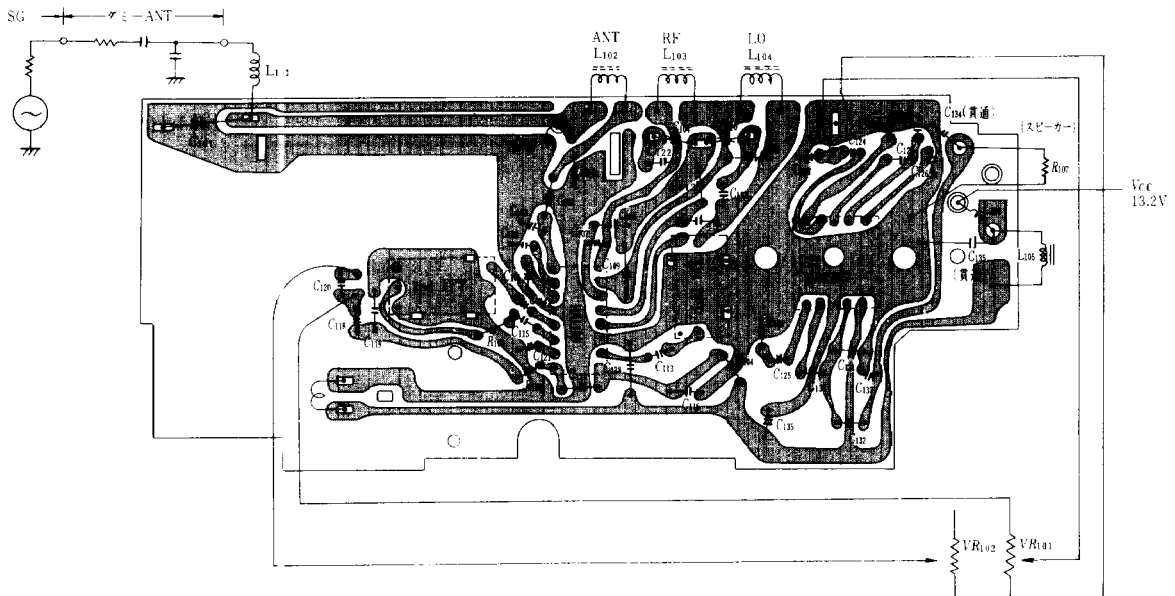

HA1199 Bottom View

■ PRINTED CIRCUIT BOARD LAYOUT PATTERN

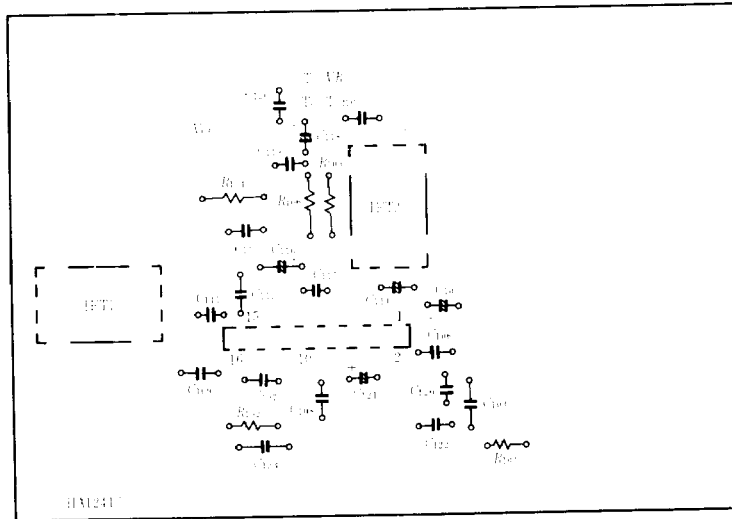

HA12417 Top View

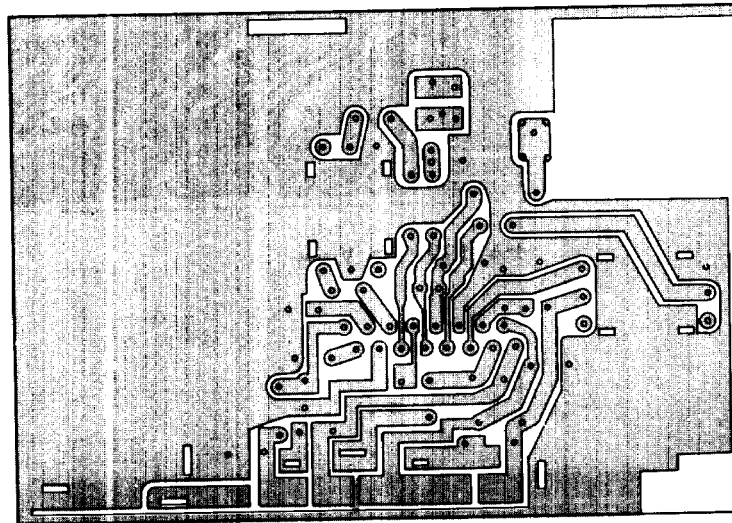

HA12417 Bottom View

SIGNAL-TO-NOISE RATIO AND OUTPUT RATIO vs. INPUT LEVEL

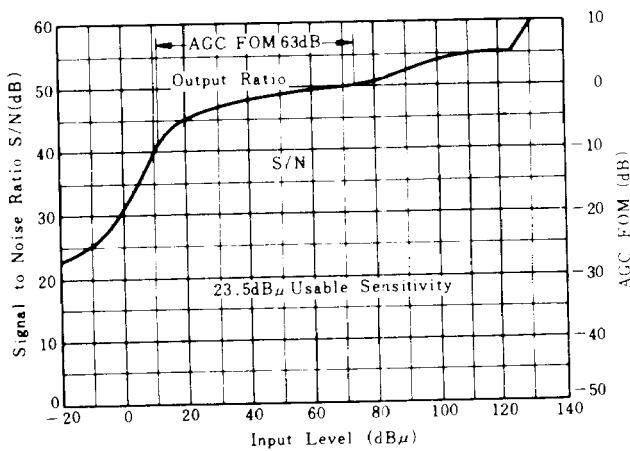

TOTAL HARMONIC DISTORTION vs. INPUT LEVEL

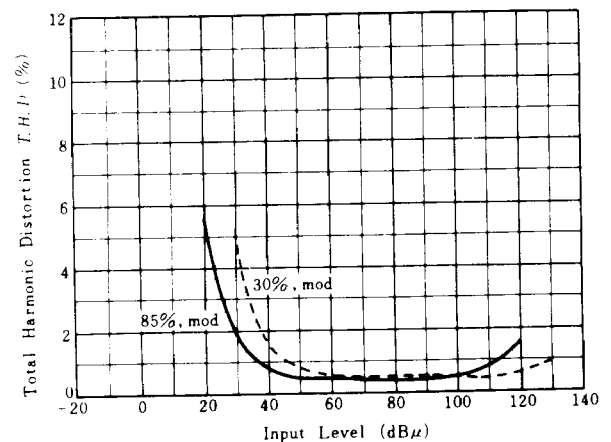

TOTAL HARMONIC DISTORTION vs. MODULATION FREQUENCY

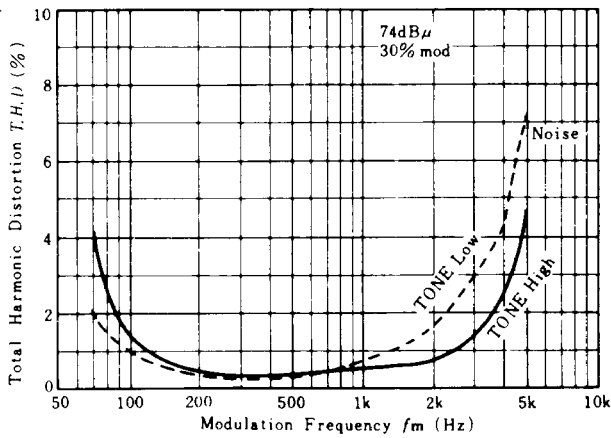

TWO-SIGNAL SELECTIVITY CHARACTERISTICS

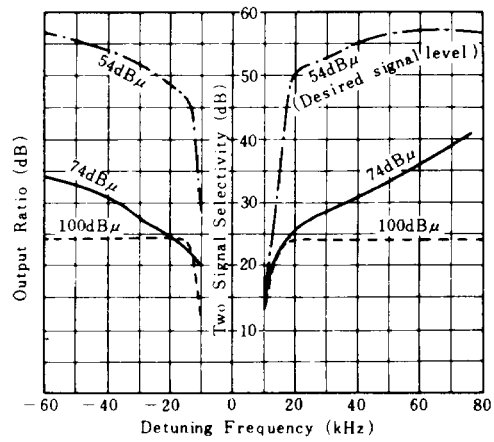

BEAT OUTPUT vs. INPUT LEVEL

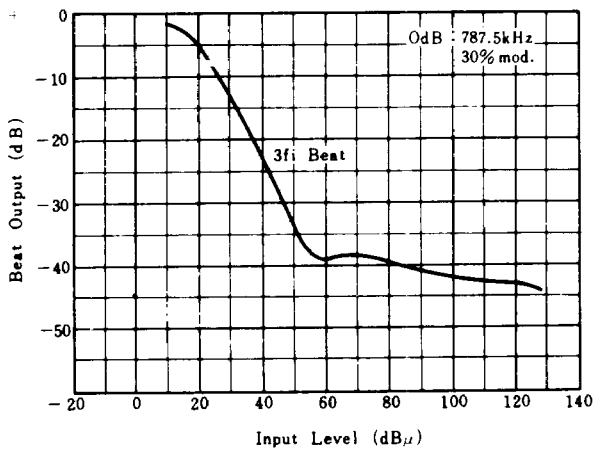

ELECTRICAL FIDELITY CHARACTERISTICS

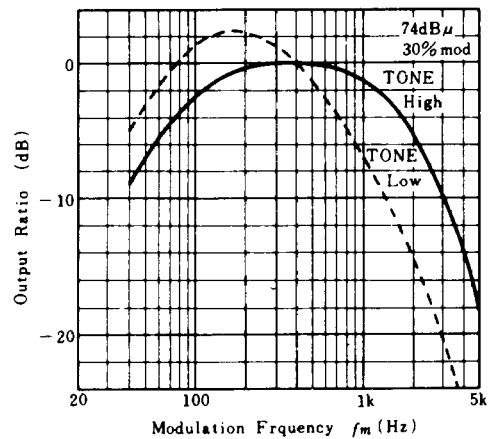

SENSITIVITY AND AGC FOM vs. SUPPLY VOLTAGE

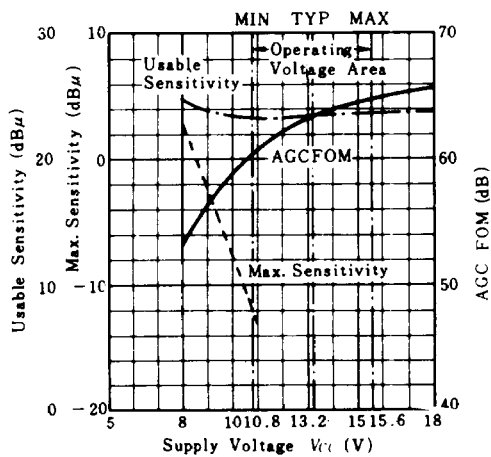

SENSITIVITY AND AGC FOM vs. RECEIVING FREQUENCY

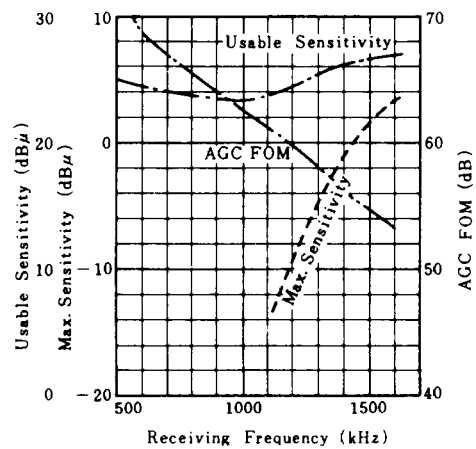

DETECTOR OUTPUT vs. AMBIENT TEMPERATURE

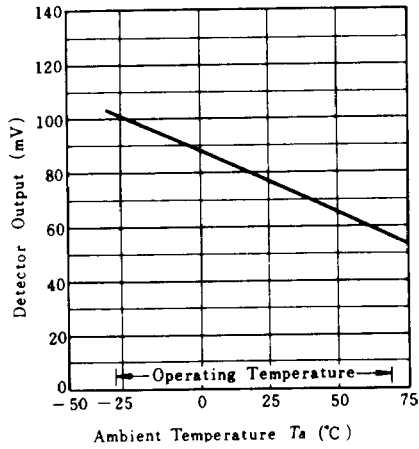

AGC FOM vs. AMBIENT TEMPERATURE

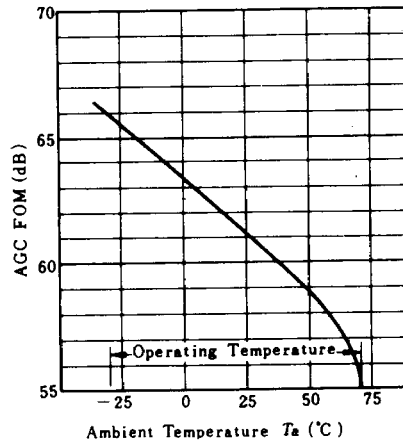

SIGNAL-TO-NOISE RATIO vs. AMBIENT TEMPERATURE

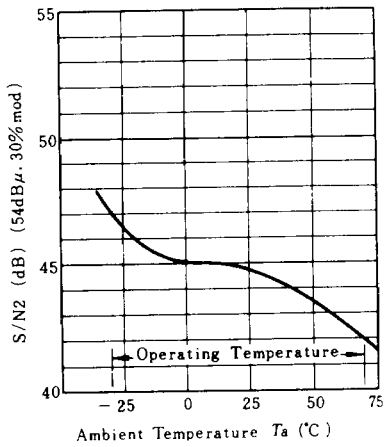

DISTORTION vs. AMBIENT TEMPERATURE

