

DESCRIPTION

The new NEC EQ1 Series automotive relays are designed for motor and lamp control applications that require a high level of quality and performance. The EQ1 has a unique two-piece design for the magnetic circuit, which result in small size, light weight, and high productivity.

FEATURES

- PC board mounting
- Same pin-layout as MR301
- Approx. 70% less relay volume than MR301
- Approx. 80% less relay space than MR301
- Approx. 90% less relay height than MR301
- Approx. 60% less relay weight than MR301

APPLICATIONS

- Motor control
- Heater control
- Solenoid control
- Lamp control



EQ1 SERIES

For Proper Use of Miniature Relays**DO NOT EXCEED MAXIMUM RATING**

Do not use relay under excessive conditions such as over ambient temperature, over voltage and over current. Incorrect use could result in abnormal heating and damage to the relay or other parts.

READ CAUTIONS IN THE SELECTION GUIDE.

Read the cautions described in NEC's "Miniature Relays" (ER0046EJ*) before dose designing your relay application.

The information in this document is subject to change without notice.

SCHEMATIC (BOTTOM VIEW)

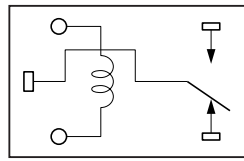

<1 Form c>

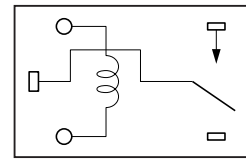

<1 Form a>

DIMENSIONS mm (inch)

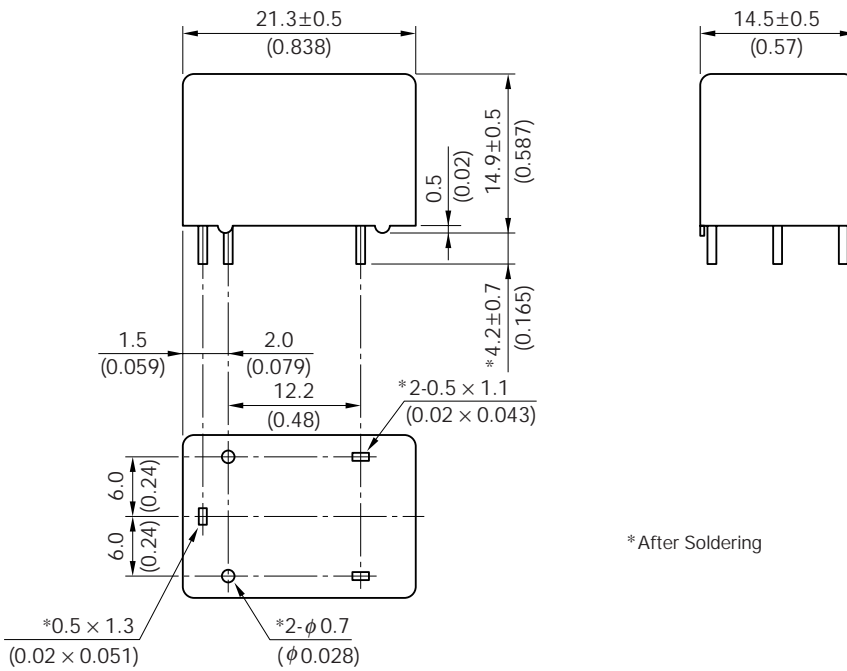

*After Soldering

PCB PAD LAYOUT mm (inch) (BOTTOM VIEW)

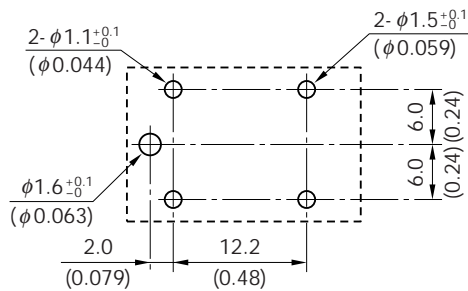

SPECIFICATION

(at 20°C)

Items		For motor control		For lamp and LCR circuit control	
		EQ1-31000S	EQ1-11040S	EQ1-11111S	EQ1-22111S
Contact Form		1 Form c		1 Form a	
Contact Rating	Max. Switching Voltage	16 Vdc			
	Max. Switching Current	35 A (at 16 Vdc)			
	Contact Resistance	Typical 5 mΩ (measured at 1 A) Initial			
Contact Material		Silver oxide complex alloy			
Operate Time (Excluding Bounce)		Typical 3 ms (at Nominal Voltage)			
Release Time (Excluding Bounce) *		Typical 4 ms (at Nominal Voltage)			
Nominal Operate Power		640 mW	1000 mW	800 mW	
Insulation Resistance		100 MΩ (at 500 Vdc)			
Breakdown Voltage	Between Open Contact	500 Vac min. (for 1 minute)			
	Between Coil and Contact	500 Vac min. (for 1 minute)			
Shock Resistance	Misoperation	98 m/s ² (10 G)			
	Destructive Failure	980 m/s ² (100 G)			
Vibration Resistance	Misoperation	10 to 300 Hz, 43 m/s ² (4.4 G)			
	Destructive Failure	10 to 500 Hz, 43 m/s ² (4.4 G) 200 hour			
Ambient Temperature		-40 to +85°C (-40 to 185°F)			
Coil Temperature Rise		60°C/W (108°F/W)			
Life Expectancy	Mechanical	1 × 10 ⁶ operations			
	Motor : 25 A lock	100 × 10 ³ operations	-		
	Lamp : 108 W Tungsten	-	100 × 10 ³ operations		
	Lamp : 120 W Halogen	-	100 × 10 ³ operations		
	LCR circuit : 70 A peak	-	100 × 10 ³ operations		
Weight		Approx. 9 g (0.32 oz)			

* with diode

COIL RATING

◆ SEALED TYPE

(at 20°C)

Items		Part Number	Nominal Voltage (Vdc)	Coil Resistance (Ω ±10%)	Must Operate Voltage (Vdc)	Must Release Voltage (Vdc)
Motor Control	General-Purpose	EQ1-31000S	12	225	6.5	0.9
	For Jump Start	EQ1-11040S		144	6.5	0.6
Lamp and LCR circuit control		EQ1-22111S		180	7.2	0.9
		EQ1-11111S		144	6.5	0.6

◆ UNSEALED TYPE

(at 20°C)

Items		Part Number	Nominal Voltage (Vdc)	Coil Resistance (Ω ±10%)	Must Operate Voltage (Vdc)	Must Release Voltage (Vdc)
Motor Control	General-Purpose	EQ1-31000	12	225	6.5	0.9
	For Jump Start	EQ1-11040		144	6.5	0.6
Lamp and LCR circuit control		EQ1-22111		180	7.2	0.9
		EQ1-11111		144	6.5	0.6

NUMBERING SYSTEM

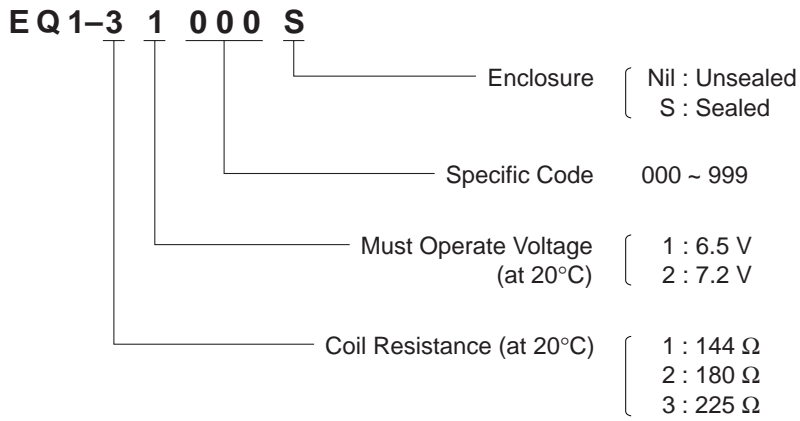

TECHNICAL DATA

Coil Temperature Rise

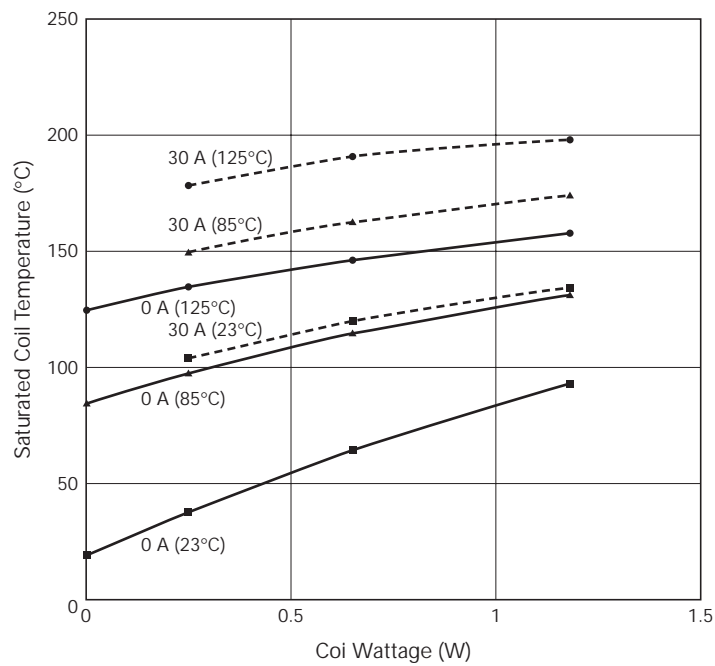

RELAY CHARACTERISTICS DISTRIBUTION (INITIAL)

- EQ1-31000S
- 200 pieces

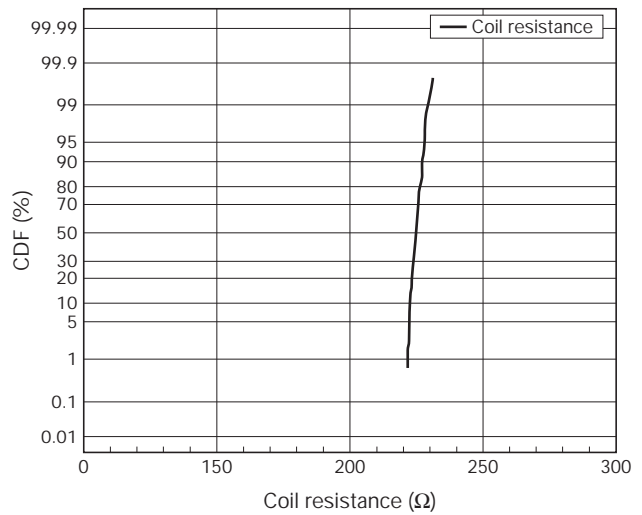
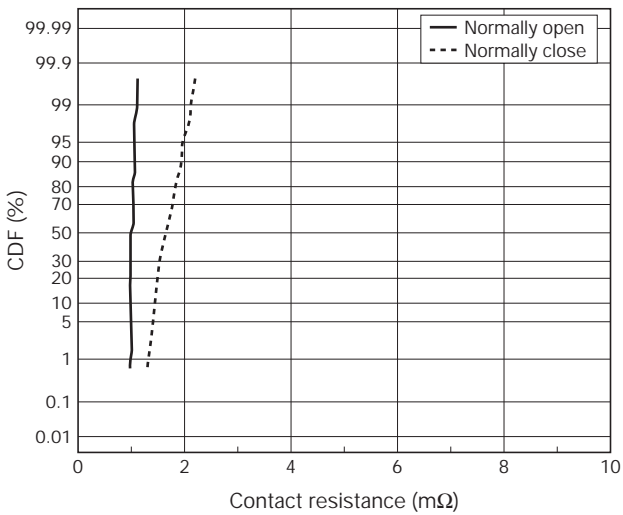
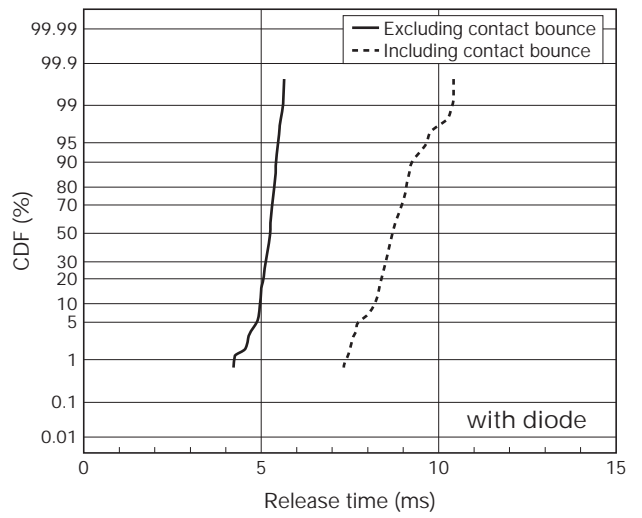
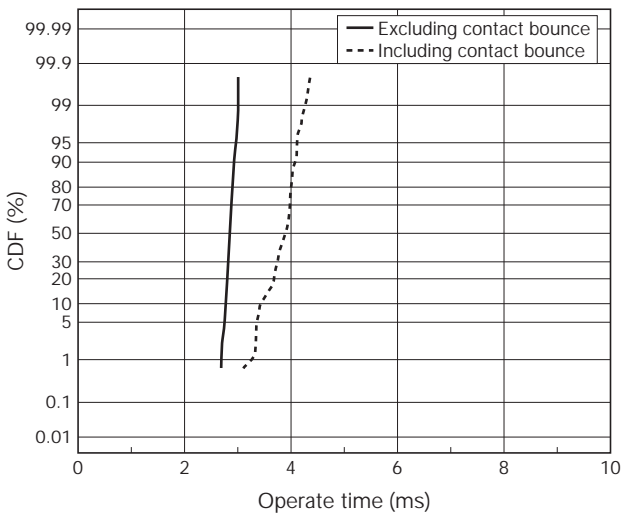
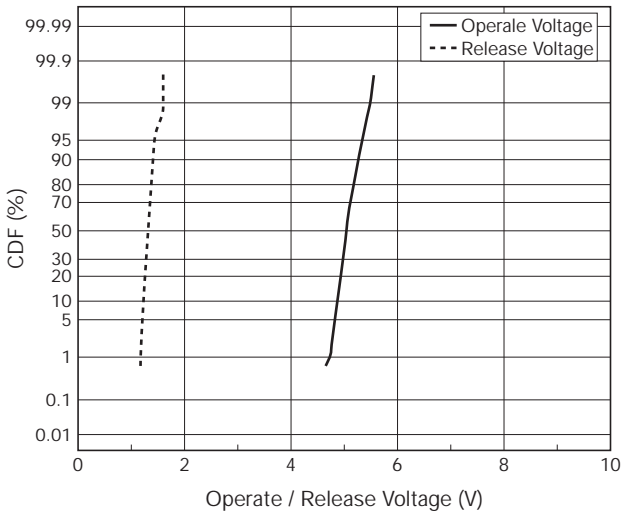

- EQ1-22111S
- 200 pieces

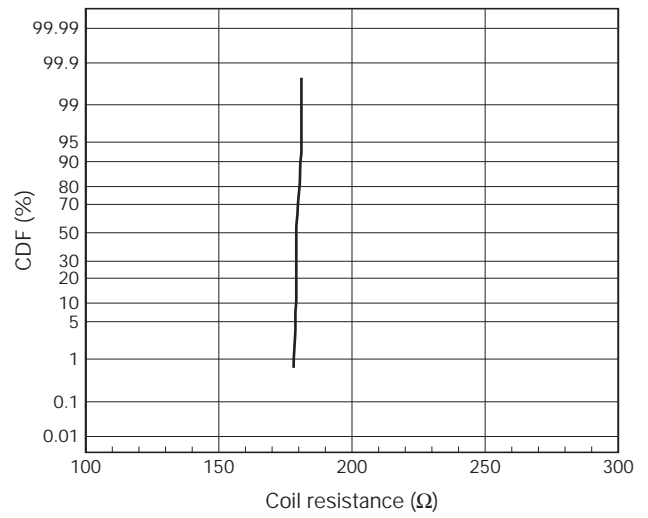
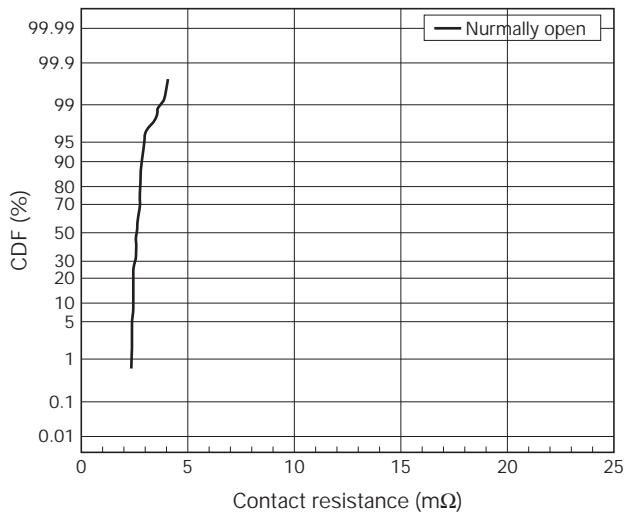
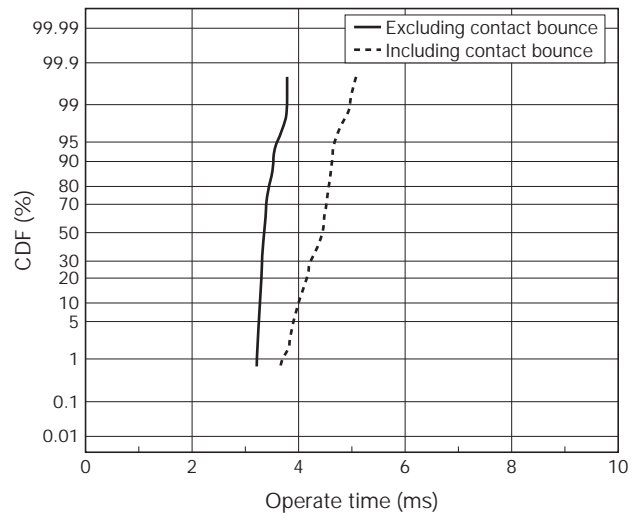
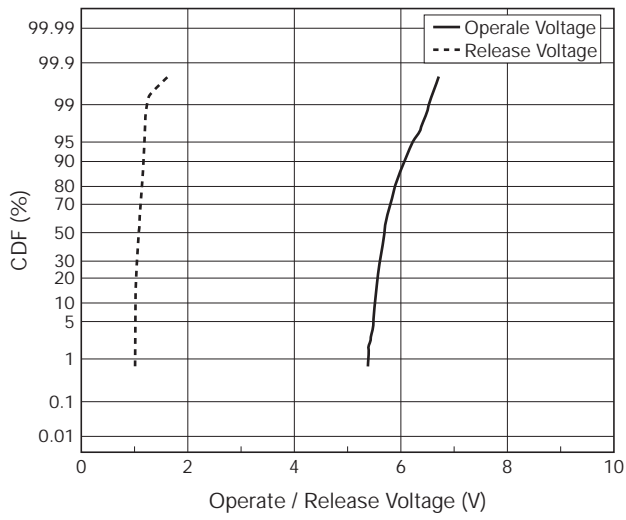

DURABILITY LIFE

Mechanical Life Test

- Ambient Temperature : 23°C
- Frequency : 12.5 Hz (50% duty)
- Contact Load : No Load
- Number of Operations : 10×10^6
- Samples : EQ1-31000S 10 pieces

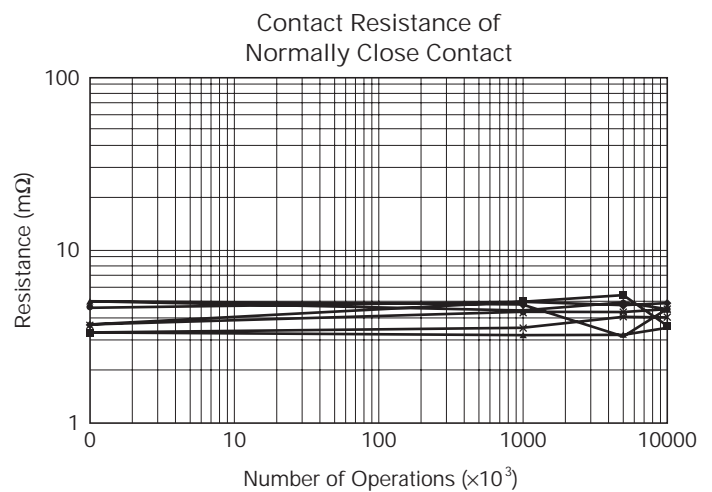
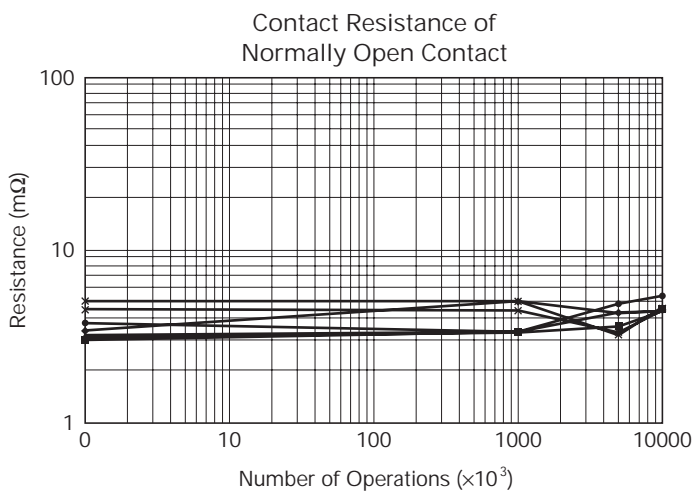
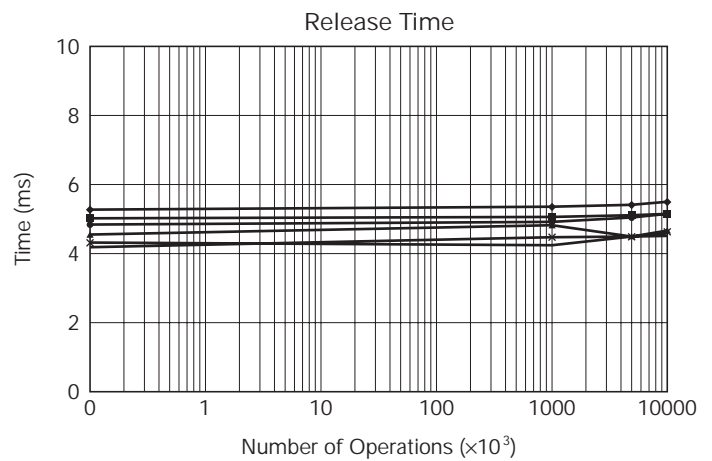
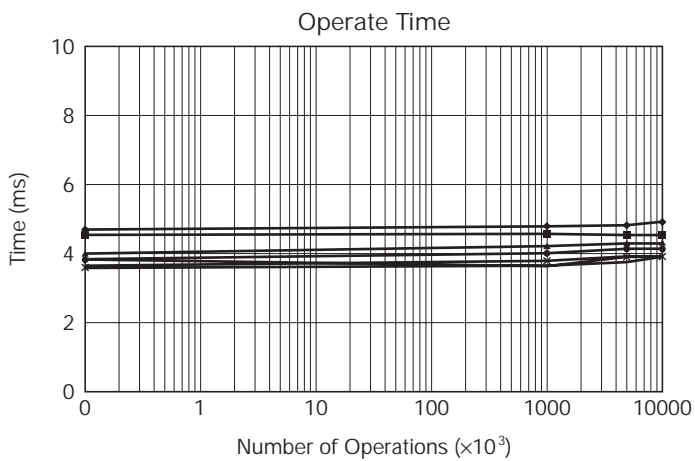
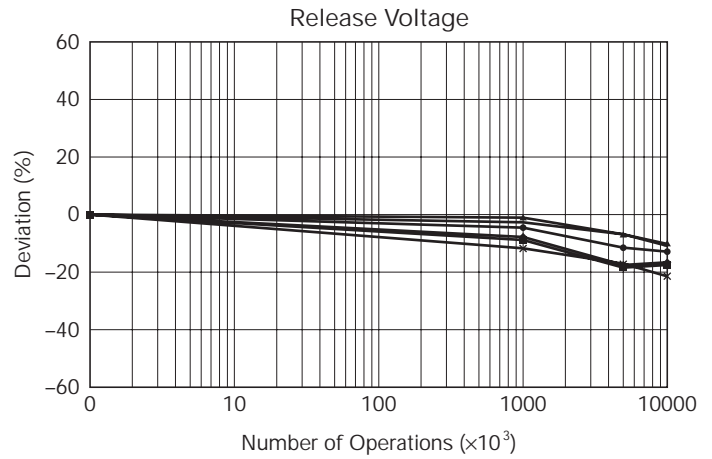
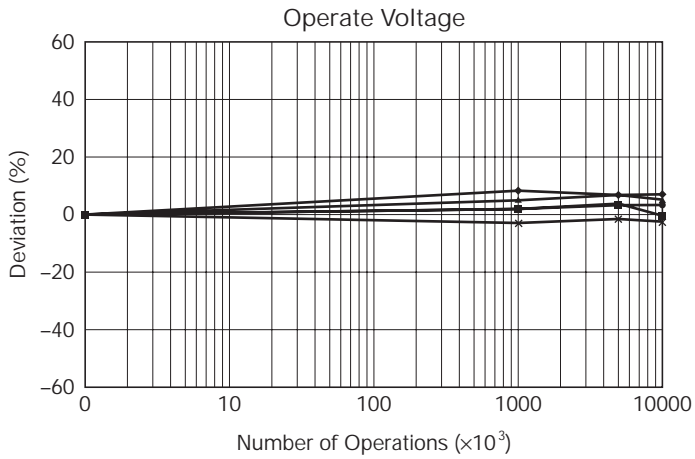

Electrical Life Test 1

- Ambient Temperature : 23°C
- Frequency : 0.2s ON, 9.8s OFF, 0.1 Hz
- Contact Load : 14 Vdc, 25 A, Locked motor
- Number of Operations : 200×10^3
- Samples : EQ1-31000S 10 pieces

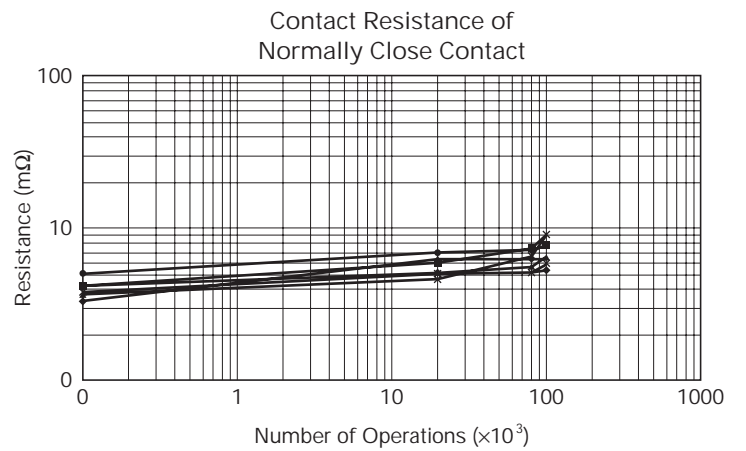
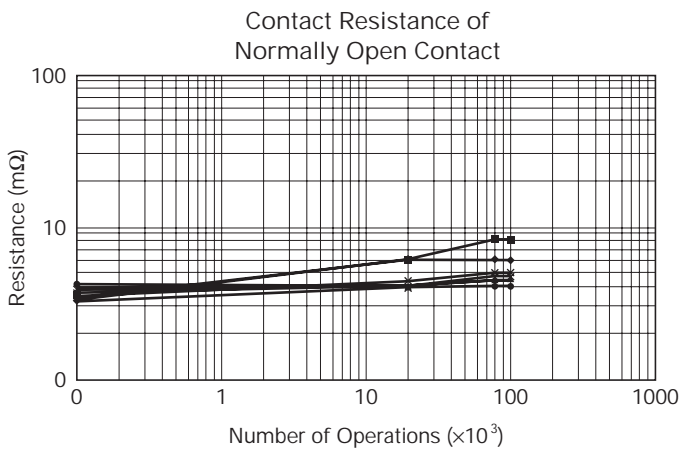
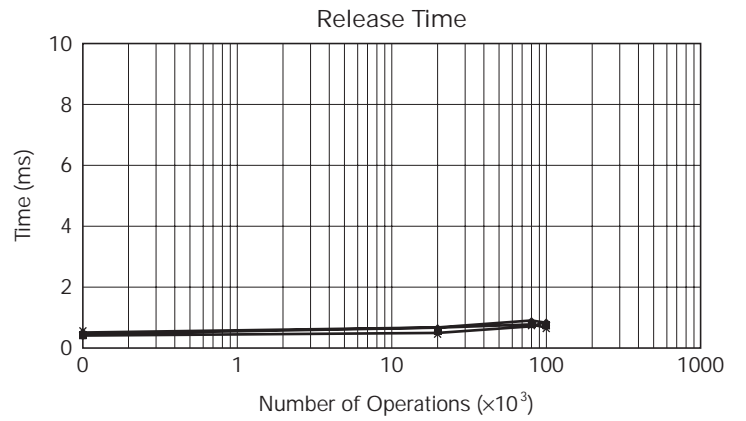
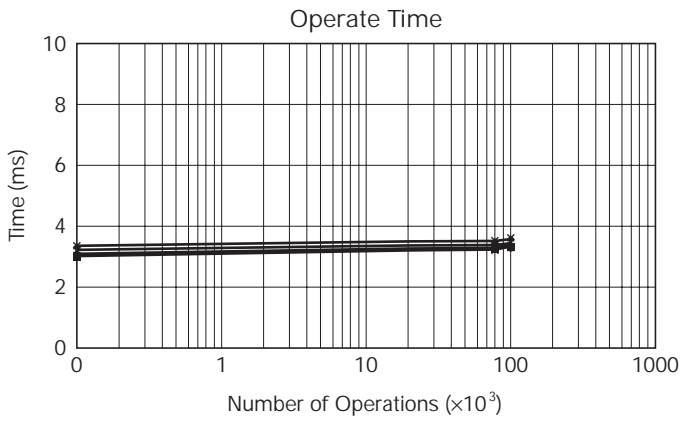
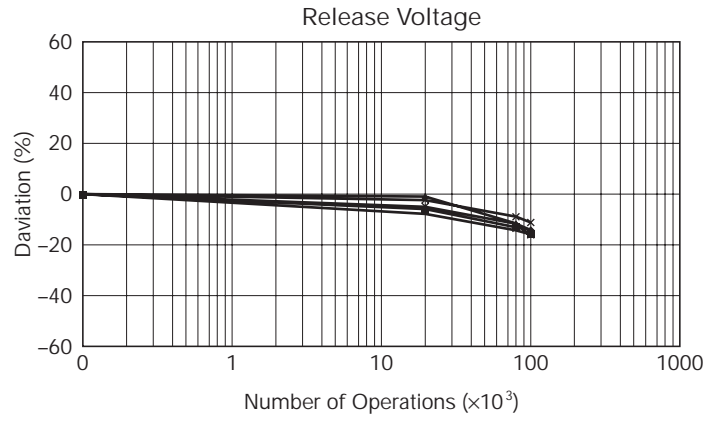
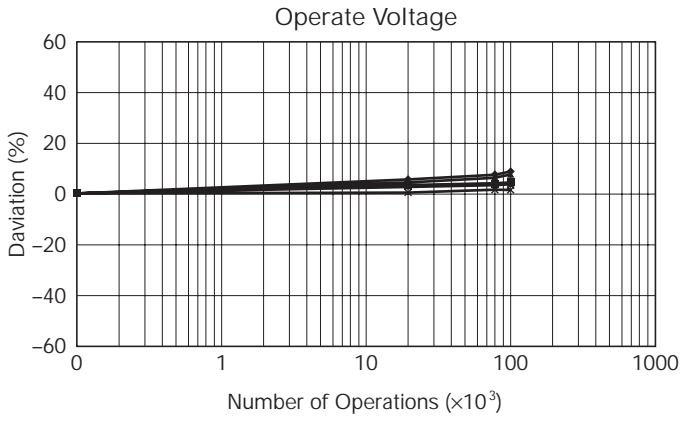
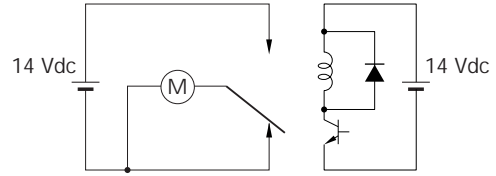

Electrical Life Test 2

- Ambient Temperature : 23°C
- Frequency : 1s ON, 29s OFF
- Contact Load : 14 Vdc, 108 W, Tungsten Lamp
- Number of Operations : 100×10^3
- Samples : EQ1-22111S 10 pieces

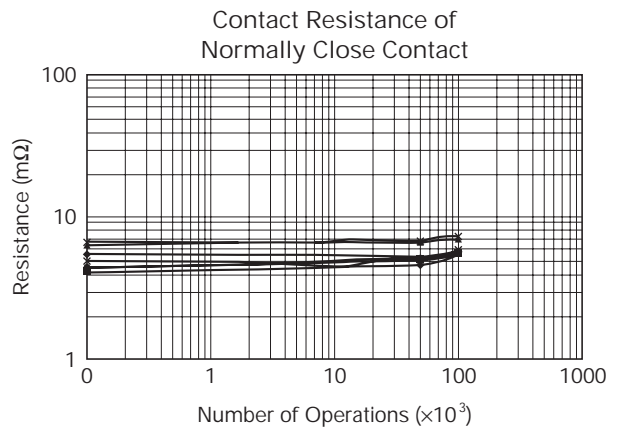
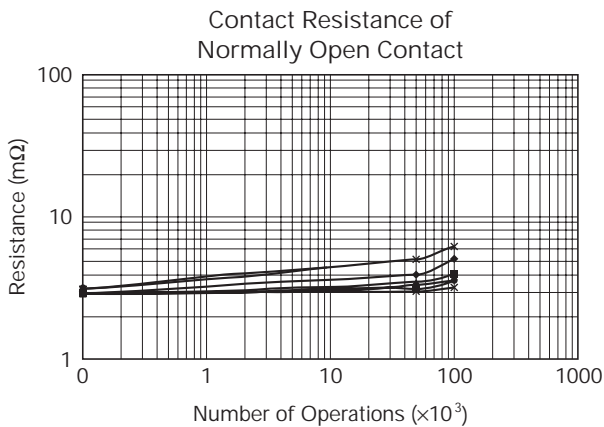
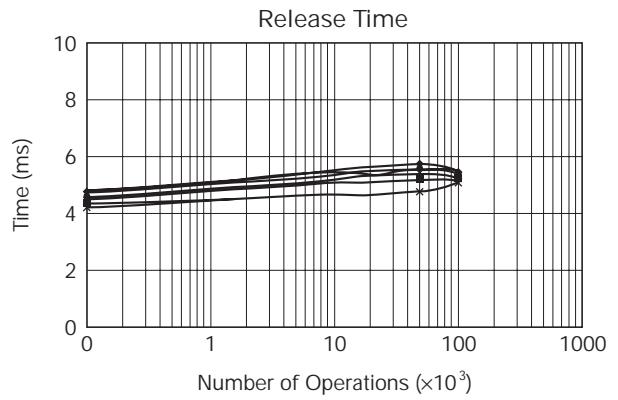
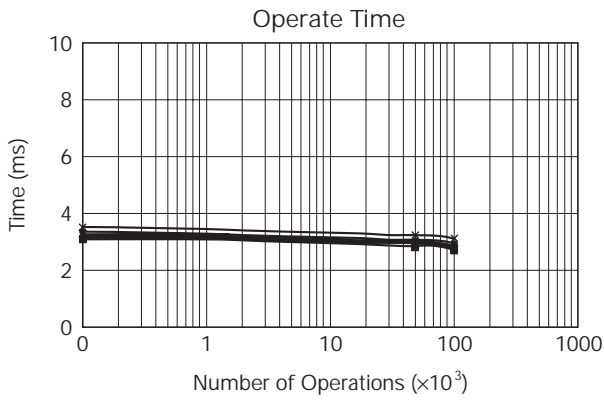
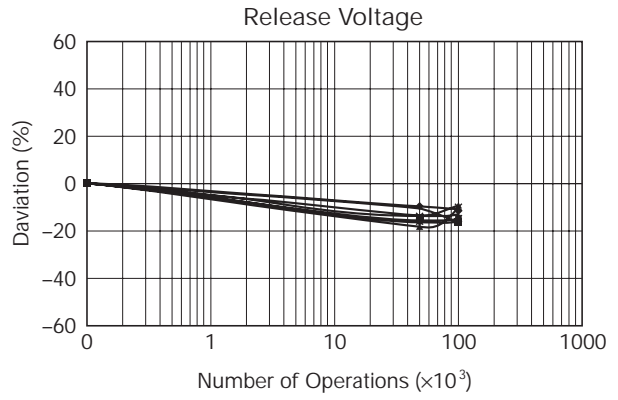
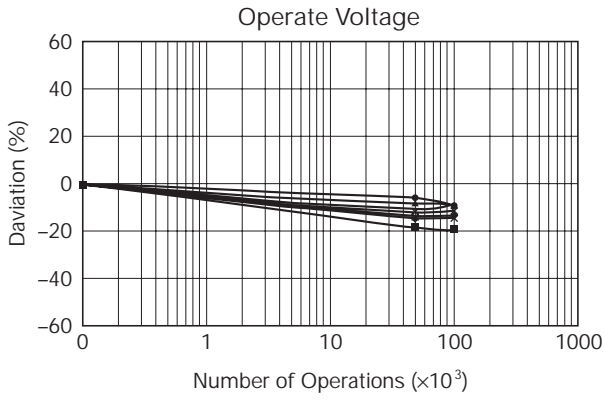
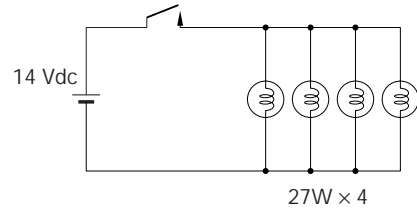

Electrical Life Test 3

- Ambient temperature : 23°C
- Frequency : 1s ON, 29s OFF
- Contact load : 14 Vdc, 120 W, Halogen Lamp
- Number of operations : 100×10^3
- Samples : EQ1-22111S, 10 pieces

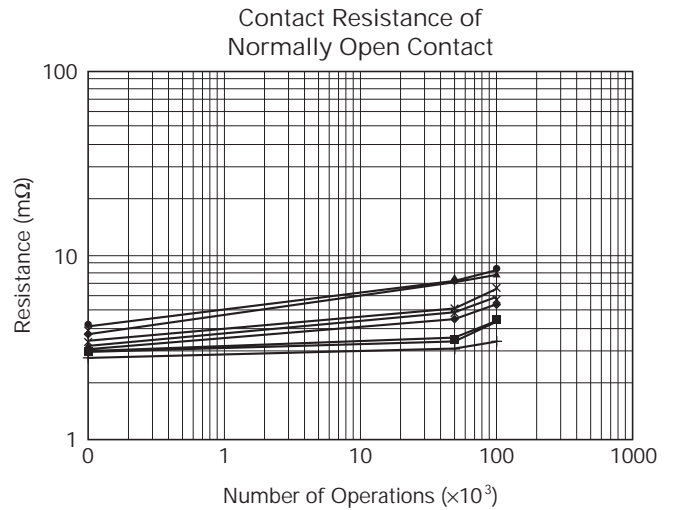
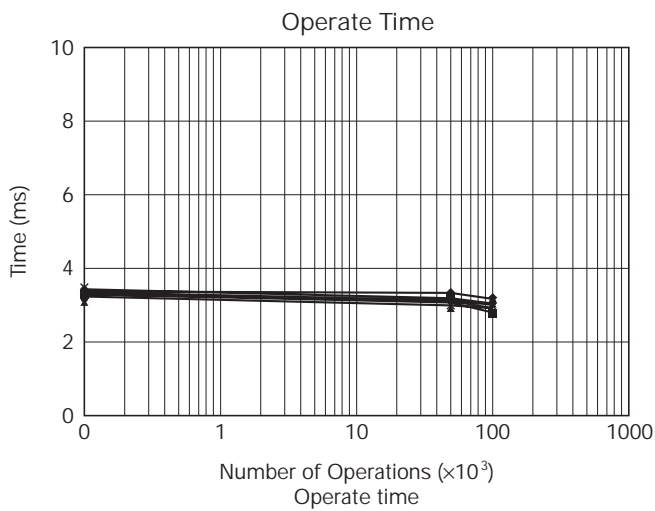
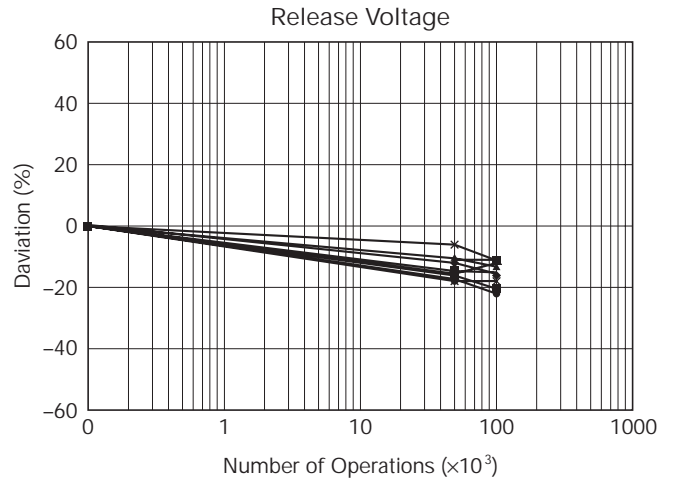
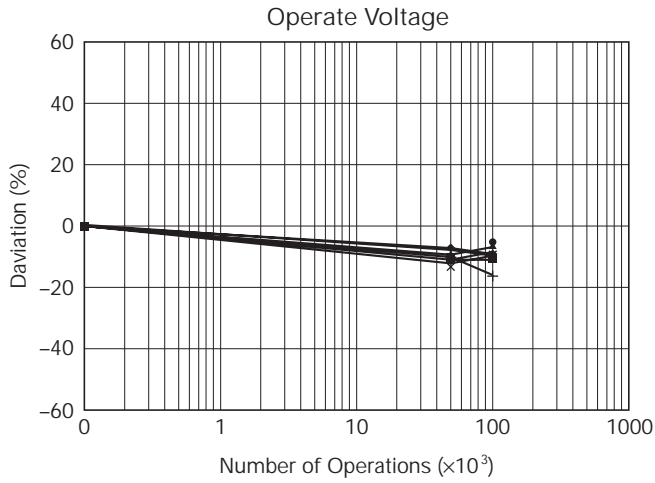
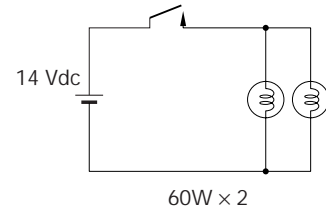

Electrical Life Test 4

- Ambient temperature : 23°C
- Frequency : 20ms ON, 3.98s OFF
- Contact load : 14 Vdc, LCR circuit
- Number of operations : 100×10^3
- Samples : EQ1-22111S, n=10

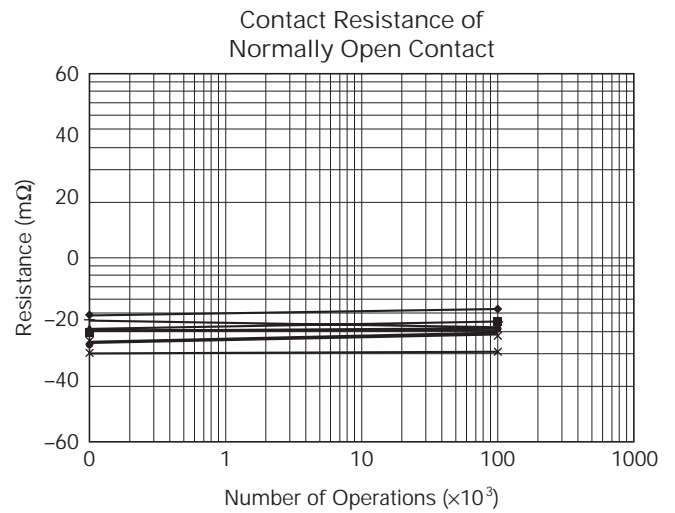
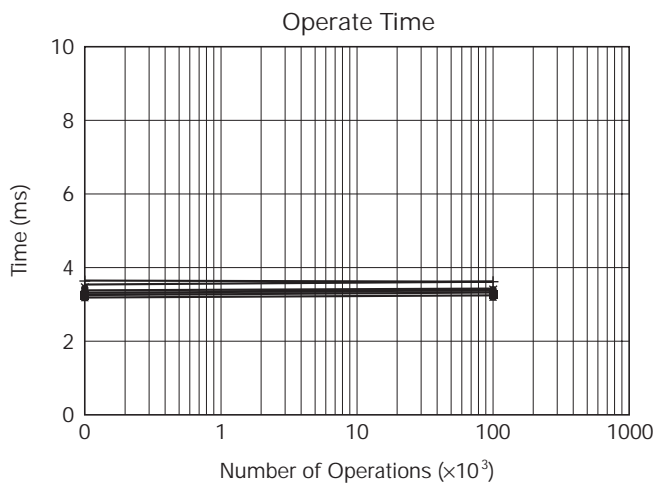
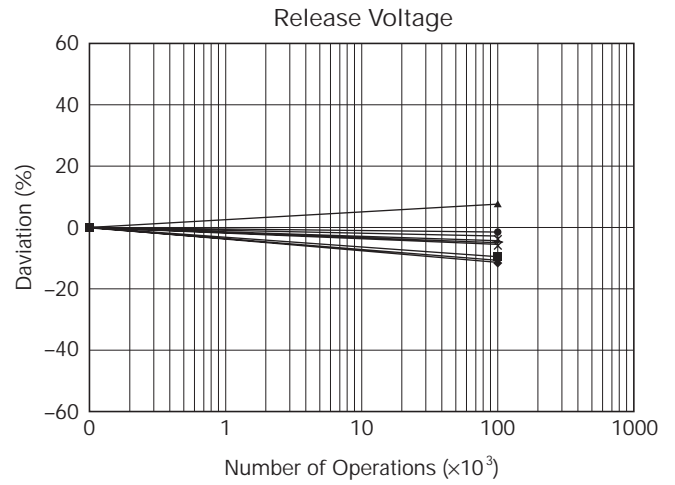
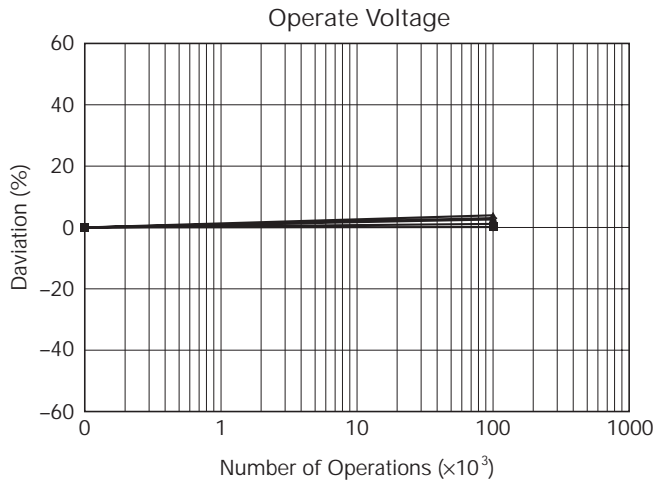
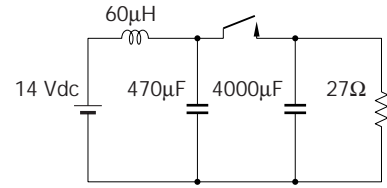

No part of this document may be copied or reproduced in any form or by any means without the prior written consent of NEC Corporation. NEC Corporation assumes no responsibility for any errors which may appear in this document.

NEC Corporation does not assume any liability for infringement of patents, copyrights or other intellectual property rights of third parties by or arising from use of a device described herein or any other liability arising from use of such device. No license, either express, implied or otherwise, is granted under any patents, copyrights or other intellectual property rights of NEC Corporation or others.

While NEC Corporation has been making continuous effort to enhance the reliability of its electronic components, the possibility of defects cannot be eliminated entirely. To minimize risks of damage or injury to persons or property arising from a defect in an NEC electronic component, customer must incorporate sufficient safety measures in its design, such as redundancy, fire-containment, and anti-failure features.

NEC devices are classified into the following three quality grades:

"Standard", "Special", and "Specific". The Specific quality grade applies only to devices developed based on a customer designated "quality assurance program" for a specific application. The recommended applications of a device depend on its quality grade, as indicated below. Customers must check the quality grade of each device before using it in a particular application.

Standard: Computers, office equipment, communications equipment, test and measurement equipment, audio and visual equipment, home electronic appliances, machine tools, personal electronic equipment and industrial robots

Special: Transportation equipment (automobiles, trains, ships, etc.), traffic control systems, anti-disaster systems, anti-crime systems, safety equipment and medical equipment (not specifically designed for life support)

Specific: Aircrafts, aerospace equipment, submersible repeaters, nuclear reactor control systems, life support systems or medical equipment for life support, etc.

The quality grade of NEC devices is "Standard" unless otherwise specified in NEC's Data Sheets or Data Books. If customers intend to use NEC devices for applications other than those specified for Standard quality grade, they should contact NEC sales representative in advance.

Anti-radioactive design is not implemented in this product.