

**SINGLE-PHASE GLASS PASSIVATED
SILICON BRIDGE RECTIFIER**
VOLTAGE RANGE 50 to 1000 Volts CURRENT 2.0 Amperes

FEATURES

- * Good for automation insertion
- * Surge overload rating - 60 amperes peak
- * Ideal for printed circuit board
- * Reliable low cost construction utilizing molded
- * Glass passivated device
- * Polarity symbols molded on body
- * Mounting position: Any

MECHANICAL DATA

- * Epoxy: Device has UL flammability classification 94V-O



DB-1

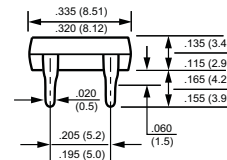
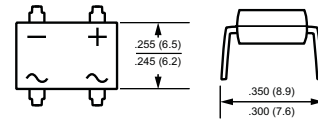

Dimensions in inches and (millimeters)

MAXIMUM RATINGS AND ELECTRICAL CHARACTERISTICS

Ratings at 25 °C ambient temperature unless otherwise specified.
resistive or inductive load.

MAXIMUM RATINGS (At $T_A = 25^\circ\text{C}$ unless otherwise noted)

RATINGS	SYMBOL	DB201	DB202	DB203	DB204	DB205	DB206	DB207	UNITS
Maximum Recurrent Peak Reverse Voltage	V_{RRM}	50	100	200	400	600	800	1000	Volts
Maximum RMS Bridge Input Voltage	V_{RMS}	35	70	140	280	420	560	700	Volts
Maximum DC Blocking Voltage	V_{DC}	50	100	200	400	600	800	1000	Volts
Maximum Average Forward Output Current at $T_A = 40^\circ\text{C}$	I_O	2.0							Amps
Peak Forward Surge Current 8.3 ms single half sine-wave superimposed on rated load (JEDEC method)	I_{FSM}	60							Amps
Typical Current Squared Time	I^2T	14.9							A ² S
Typical Thermal Resistance (Note 2)	$R_{\theta JA}$	40							°C/W
	$R_{\theta JL}$	15							
Operating and Storage Temperature Range	T_J, T_{STG}	-55 to + 150							°C

ELECTRICAL CHARACTERISTICS (At $T_A = 25^\circ\text{C}$ unless otherwise noted)

CHARACTERISTICS	SYMBOL	DB201	DB202	DB203	DB204	DB205	DB206	DB207	UNITS
Maximum Forward Voltage Drop per Bridge Element at 2.0A DC	V_F	1.1							Volts
Maximum Reverse Current at Rated DC Blocking Voltage per element	I_R	@ $T_A = 25^\circ\text{C}$							uAmps
		@ $T_A = 125^\circ\text{C}$							mAmps

Note: 1. "Fully ROHS compliant", "100% Sn plating (Pb-free).
2. Thermal Resistance: Mounted on PCB.
3. Available in Halogen-free epoxy by adding suffix -HF after the part nbr.

2015-06
REV: 0

RATING AND CHARACTERISTICS CURVES (DB201 THRU DB207)

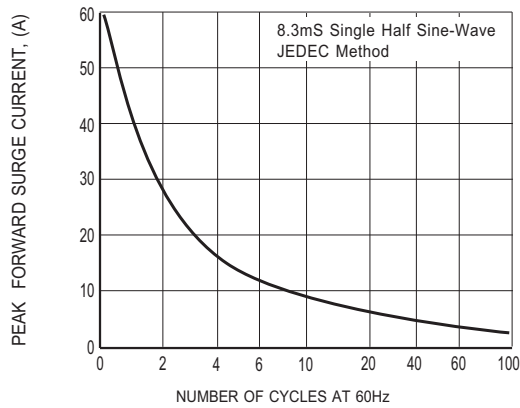

FIG. 1 - MAXIMUM NON-REPETITIVE FORWARD SURGE CURRENT

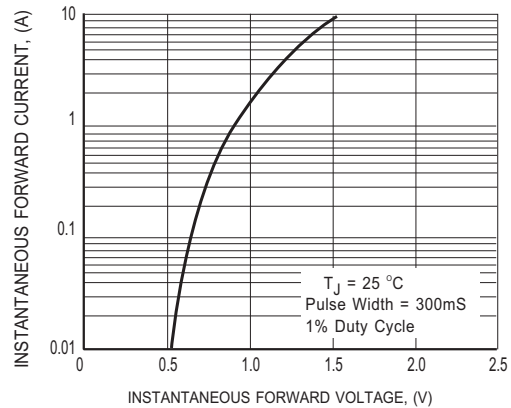

FIG. 2 TYPICAL INSTANTANEOUS FORWARD CHARACTERISTICS

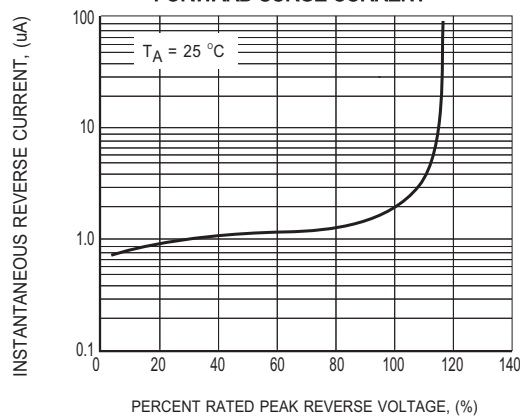

FIG. 3 TYPICAL REVERSE CHARACTERISTICS

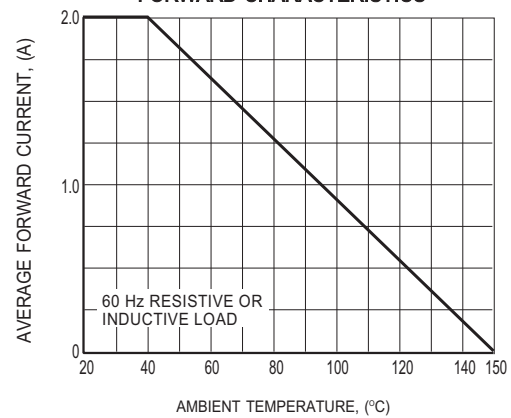

FIG. 4 TYPICAL FORWARD CURRENT DERATING CURVE



RECTRON

Attachment information about DB20X

1. Internal Circuit

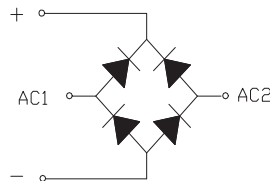

2. Marking on the body

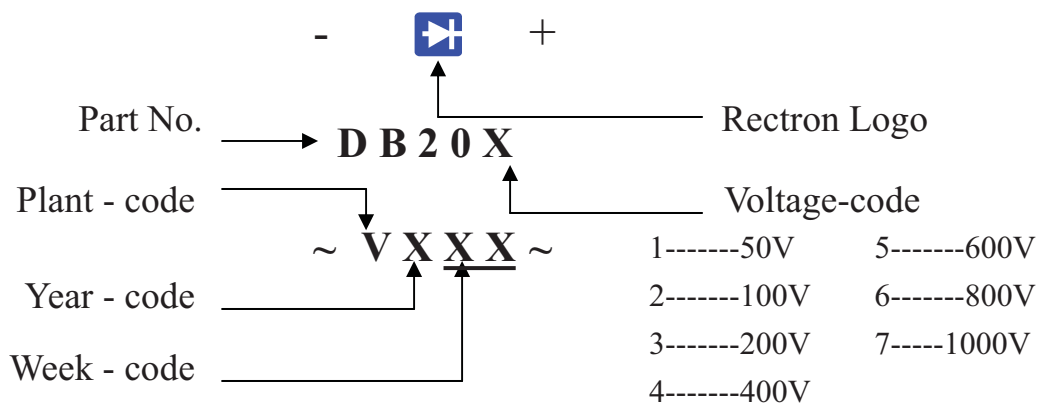

3. Items marked on the inner box and carton

3.1 On the box (for -C)

CUSTOMER
TYPE
LOT NO.
QUANTITY
Q.A.
DATE

3.2 On the carton

CUSTOMER
TYPE
QUANTITY
LOT NO.
REMARK

PACKAGING OF DIODE AND BRIDGE RECTIFIERS

TUBE PACK

PACKAGE	PACKING CODE	EA PER BOX	INNER BOX SIZE (mm)	CARTON SIZE (mm)	EA PER CARTON	WEIGHT(Kg)
DB-1	-C	2,500	450*140*84	464*305*283	15,000	14.30

DISCLAIMER NOTICE

Rectron Inc reserves the right to make changes without notice to any product specification herein, to make corrections, modifications, enhancements or other changes. Rectron Inc or anyone on its behalf assumes no responsibility or liability for any errors or inaccuracies. Data sheet specifications and its information contained are intended to provide a product description only. "Typical" parameters which may be included on RECTRON data sheets and/ or specifications can and do vary in different applications and actual performance may vary over time. Rectron Inc does not assume any liability arising out of the application or use of any product or circuit.

Rectron products are not designed, intended or authorized for use in medical, life-saving implant or other applications intended for life-sustaining or other related applications where a failure or malfunction of component or circuitry may directly or indirectly cause injury or threaten a life without expressed written approval of Rectron Inc. Customers using or selling Rectron components for use in such applications do so at their own risk and shall agree to fully indemnify Rectron Inc and its subsidiaries harmless against all claims, damages and expenditures.