

Toroidal Inductors

Medium Current

CTP4563

CTP4563 is a medium current inductor with the following data and features:

- **Core type:** 1.57" o.d., Moly-Permalloy Powder, perm 125.
 - **Power rating:** 4.50 watts for temp. rise 50°C.
 - **Typical applications:** Switching Inductors in Switch Mode Power Supplies.
- Three mounting styles are offered:**
- 1 Flying leads (1.00"), for vertical or horizontal mounting.
 - 2 4-pin header, for vertical mounting.
 - 3 Threaded center hole, flying leads (2.00").



MECHANICAL

Style 1

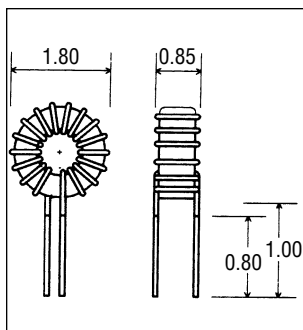

Style 2

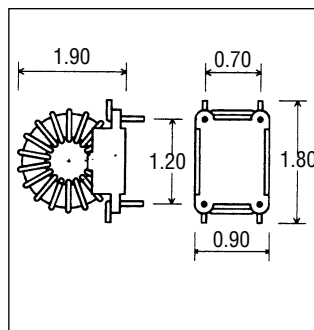

Style 3

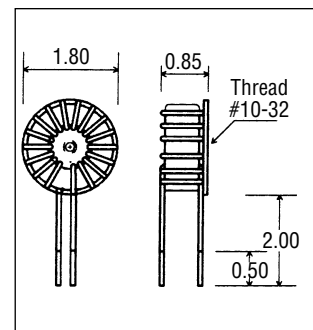

ELECTRICAL SPECIFICATION

Ordering Information: Substitute the style number for the asterisk (*). Example: CTP4563, Style 1, 56uH. Order: CTP4563 - 116

Part No. CTP4563 -	Ind. (uH)	DCR Ohms	Rated Current Amp. RMS	I (amp.) @ Lsat. 10%	I (amp.) @ Lsat. 25%	I (amp.) @ Lsat. 50%	Part No. CTP4563 -	Ind. (uH)	DCR Ohms	Rated Current Amp. RMS	I (amp.) @ Lsat. 10%	I (amp.) @ Lsat. 25%	I (amp.) @ Lsat. 50%
* 01	3.3	0.001	57.0	35.3	53.0	88.3	* 17	68	0.019	15.3	7.8	11.7	19.5
* 02	3.9	0.002	48.8	32.5	48.8	81.3	* 18	82	0.021	14.7	7.1	10.6	17.7
* 03	4.7	0.002	46.7	29.6	44.4	74.0	* 19	100	0.023	14.0	6.4	9.6	16.0
* 04	5.6	0.002	44.8	27.1	40.7	67.8	* 20	120	0.025	13.3	5.9	8.8	14.6
* 05	6.8	0.003	38.1	24.6	36.9	61.5	* 21	150	0.028	12.6	5.2	7.9	13.1
* 06	8.2	0.003	36.4	22.4	33.6	56.0	* 22	180	0.031	12.1	4.8	7.2	12.0
* 07	10	0.005	30.9	20.3	30.4	50.7	* 23	220	0.034	11.5	4.3	6.5	10.8
* 08	12	0.005	29.6	18.5	27.8	46.3	* 24	270	0.038	10.9	3.9	5.9	9.8
* 09	15	0.007	25.0	16.6	24.9	41.4	* 25	330	0.042	10.4	3.5	5.3	8.8
* 10	18	0.008	23.9	15.1	22.7	37.8	* 26	390	0.045	10.0	3.3	4.9	8.1
* 11	22	0.009	22.8	13.7	20.5	34.2	* 27	470	0.050	9.5	3.0	4.4	7.4
* 12	27	0.012	19.3	12.4	18.5	30.9	* 28	560	0.054	9.1	2.7	4.1	6.8
* 13	33	0.013	18.3	11.2	16.8	27.9	* 29	680	0.060	8.7	2.5	3.7	6.2
* 14	39	0.015	17.6	10.3	15.4	25.7	* 30	820	0.066	8.3	2.2	3.4	5.6
* 15	47	0.016	16.8	9.4	14.0	23.4	* 31	1000	0.073	7.9	2.0	3.0	5.1
* 16	56	0.017	16.1	8.6	12.9	21.4	* 32	1200	0.079	7.5	1.9	2.8	4.6

CTP4563