

General Description:

Using micro trench design and advanced Field Stop (FS) technology, offering superior conduction and switching performances.

RoHS Compliant.

Features:

- FS Trench Technology, Positive temperature coefficient
- Low saturation voltage:

$V_{CE(sat),TYP}=1.43V @I_C=120A,V_{GE}=15V;$

- Low switching loss

Applications

- UPS
- Solar converts
- Charger

V_{CES}	750	V
I_C	120	A
$P_{tot} (T_C=25^\circ C)$	491	W
$V_{CE(sat)}$	1.43	V

Package:TO-247Plus

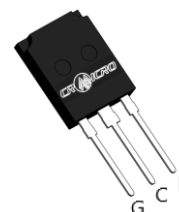

Equivalent circuit:

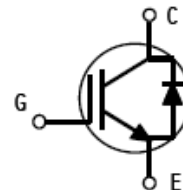

Package Parameters

Type	Package	Marking	Packing
CRG120T75AX7HDZ	TO-247Plus	G120T75AX7HDZ	Tube

Absolute Maximum Ratings ($T_C = 25^\circ\text{C}$ unless otherwise specified):

Symbol	Parameter	Rating	Units
V_{CES}	Collector-Emitter Voltage	750	V
V_{GES}	Gate- Emitter Voltage	± 20	V
	Gate- Emitter Voltage ($t_p \leq 10\mu\text{s}, D < 0.01$)	± 30	
I_C^{a1}	Collector Current @ $T_C = 25^\circ\text{C}$	180	A
	Collector Current @ $T_C = 100^\circ\text{C}$	120	
I_{CM}	Pulsed Collector Current @ $T_C = 25^\circ\text{C}$	480	A
I_F^{a2}	Diode Continuous Forward Current @ $T_C = 25^\circ\text{C}$	180	A
	Diode Continuous Forward Current @ $T_C = 100^\circ\text{C}$	120	
I_{FM}	Diode Maximum Forward Current	480	A
P_D	Power Dissipation @ $T_C = 25^\circ\text{C}$	491	W
	Power Dissipation @ $T_C = 100^\circ\text{C}$	245	
T_j^{a3}	Operating Junction temperature range	$-40 \sim 175$	$^\circ\text{C}$
T_{stg}	Storage Temperature Range	$-55 \sim 150$	$^\circ\text{C}$
T_L	Maximum Temperature for Soldering	270	$^\circ\text{C}$

Thermal Characteristics

Symbol	Parameter	Typ.	Max.	Units
$R_{\theta JC}$	Thermal Resistance, Junction to case for IGBT	--	0.31	$^\circ\text{C}/\text{W}$
$R_{\theta JC}$	Thermal Resistance, Junction to case for Diode	--	0.38	$^\circ\text{C}/\text{W}$
$R_{\theta JA}$	Thermal Resistance, Junction to Ambient	--	40	$^\circ\text{C}/\text{W}$

Electrical Characteristics of the IGBT ($T_C = 25^\circ\text{C}$ unless otherwise specified):

Symbol	Parameter	Test Conditions	SPEC			Units
			Min.	Typ.	Max.	
OFF Characteristics						
$V_{(BR)CES}$	Collector-Emitter Breakdown Voltage	$V_{GE}=0\text{V}, I_{CE}=250\mu\text{A}$	750	--	--	V
I_{CES}	Collector-Emitter Leakage Current	$V_{GE}=0\text{V}, V_{CE}=750\text{V}$	--	--	1.0	mA
$I_{GES(F)}$	Gate to Emitter Forward Leakage	$V_{GE}=+20\text{V}$	--	--	+250	nA
$I_{GES(R)}$	Gate to Source Reverse Leakage	$V_{GE}=-20\text{V}$	--	--	-250	nA
ON Characteristics						
$V_{CE(sat)}$	Collector-Emitter Saturation Voltage	$I_C=120\text{A}, V_{GE}=15\text{V}, T_C=25^\circ\text{C}$	--	1.43	1.8	V
		$I_C=120\text{A}, V_{GE}=15\text{V}, T_C=175^\circ\text{C}$	--	1.76	--	V
$V_{GE(th)}$	Gate Threshold Voltage	$I_C=1\text{mA}, V_{CE}=V_{GE}$	4	5	6	V
Pulse width $t_p \leq 300\mu\text{s}, \delta \leq 2\%$						
Dynamic Characteristics						

C_{ies}	Input Capacitance	$V_{CE}=25V, V_{GE}=0V$ $f=100KHz$	--	9248	--	pF
C_{oes}	Output Capacitance		--	249	--	
C_{res}	Reverse Transfer Capacitance		--	39	--	
Switching Characteristics						
$t_{d(on)}$	Turn-on Delay Time	$V_{CE}=400V, I_C=120A,$ $R_g=10\Omega, V_{GE}=15V,$ Inductive Load, $T_J=25^\circ C$	--	45	--	ns
t_r	Rise Time		--	82	--	
$t_{d(off)}$	Turn-Off Delay Time		--	226	--	
t_f	Fall Time		--	52	--	
E_{on}^{a4}	Turn-On Switching Loss		--	4.3	--	mJ
E_{off}	Turn-Off Switching Loss		--	2.3	--	
E_{ts}	Total Switching Loss	--	6.6	--		
$t_{d(on)}$	Turn-on Delay Time	$V_{CE}=400V, I_C=120A,$ $R_g=10\Omega, V_{GE}=15V,$ Inductive Load, $T_J=175^\circ C$	--	38	--	ns
t_r	Rise Time		--	76	--	
$t_{d(off)}$	Turn-Off Delay Time		--	289	--	
t_f	Fall Time		--	68	--	
E_{on}^{a4}	Turn-On Switching Loss		--	5.4	--	mJ
E_{off}	Turn-Off Switching Loss		--	3.1	--	
E_{ts}	Total Switching Loss	--	8.6	--		
Q_g	Total Gate Charge	$V_{CE}=600V, I_C=120A,$ $V_{GE}=15V$	--	394	--	nC
Q_{ge}	Gate to Emitter Charge		--	56	--	
Q_{gc}	Gate to Collector Charge		--	172	--	
Electrical Characteristics of the DIODE ($T_C=25^\circ C$ unless otherwise specified):						
V_F	Diode Forward Voltage	$I_F=120A, T_C=25^\circ C$	--	2.1	2.5	V
		$I_F=120A, T_C=175^\circ C$	--	1.95	--	V
T_{rr}	Reverse Recovery Time	$I_F=120A$ $di/dt=200A/\mu S$	--	386	--	ns
I_{rrm}	Reverse Recovery Current		--	7.33	--	A
Q_{rr}	Reverse Recovery Charge		--	1170	--	nC

Notes:

- a1: The collector DC current is limited by the maximum junction temperature, limited by the bond wire current capacity at 25 °C
- a2: FRD DC forward current is limited by the maximum junction temperature, limited by the bond wire current capacity at 25 °C
- a3: Repetitive rating; pulse width limited by maximum junction temperature; Under overloading conditions, it is allowed to operate under the maximum junction temperature $T_{vjop}=175^\circ C$, and the maximum duty cycle is less than 20% (maximum lasting 60s)
- a4: Turn-on losses include diode losses

Typical Performance Characteristics:

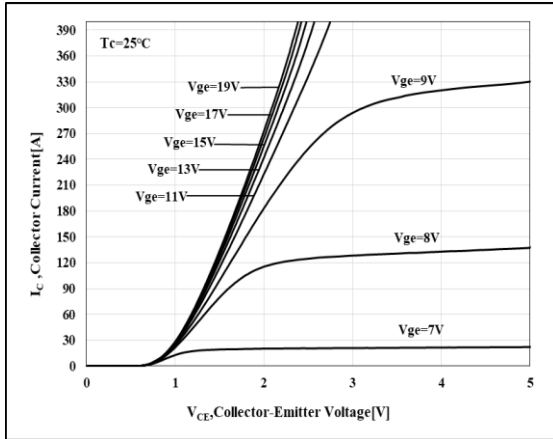

Figure 1. Output Characteristics

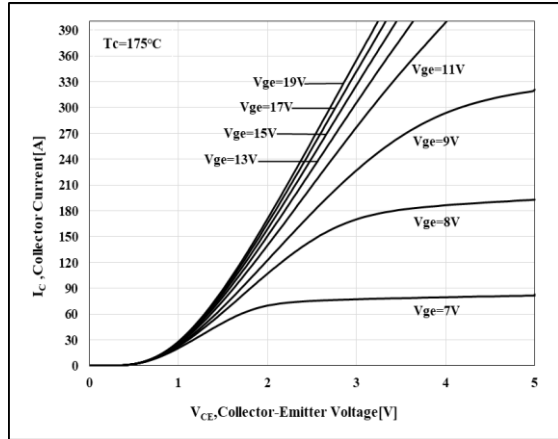

Figure 2. Output Characteristics

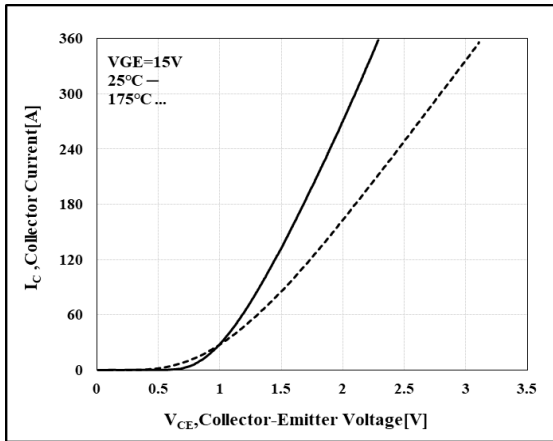

Figure 3. Saturation Voltage Characteristics

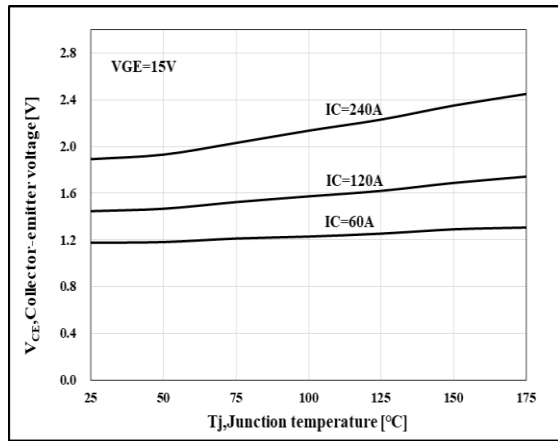

Figure 4. Saturation Voltage -T_c Characteristics

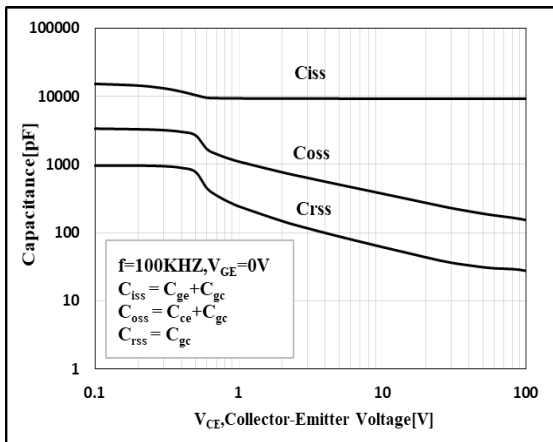

Figure 5. Capacitance Characteristics

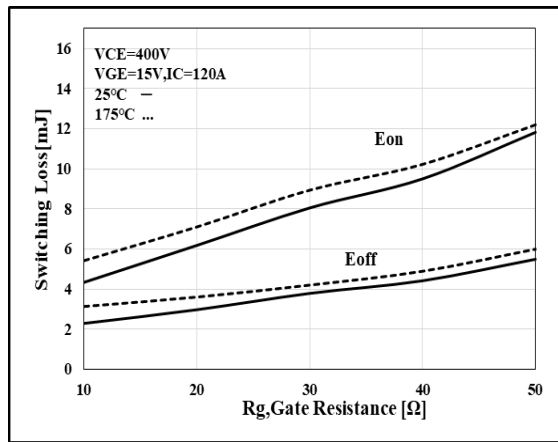

Figure 6. Switching Loss-R_g Characteristics

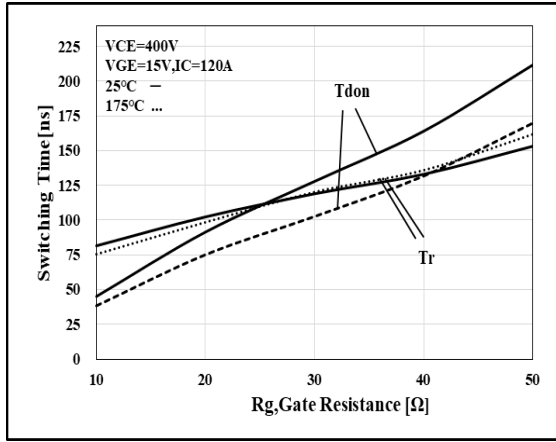

Figure 7. Switching Time- R_g Characteristics

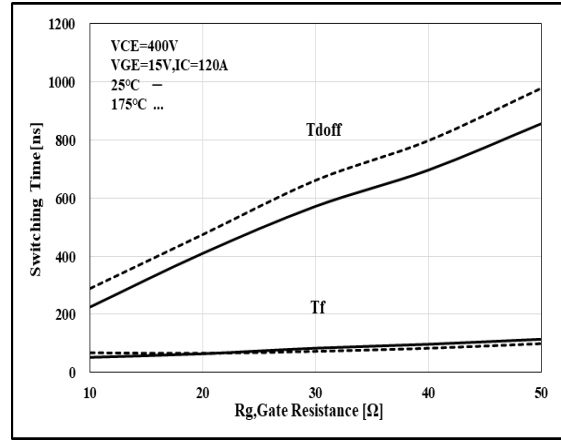

Figure 8. Switching Time- R_g Characteristics

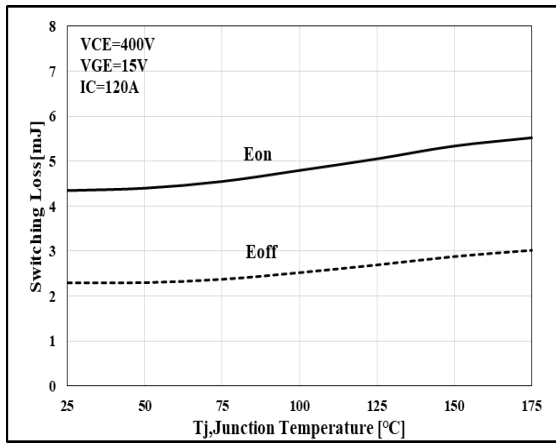

Figure 9. Switching Loss- T_j Characteristics

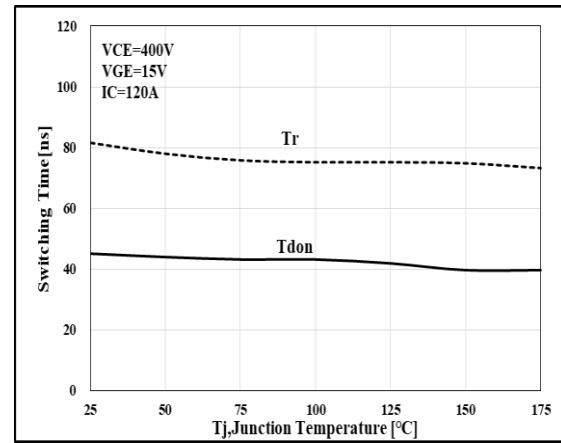

Figure 10. Switching Time- T_j Characteristics

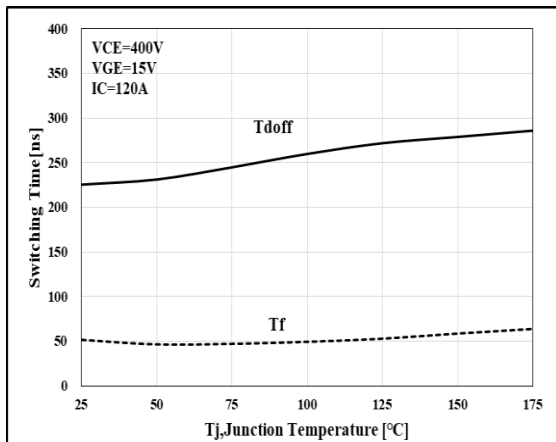

Figure 11. Switching Time- T_j Characteristics

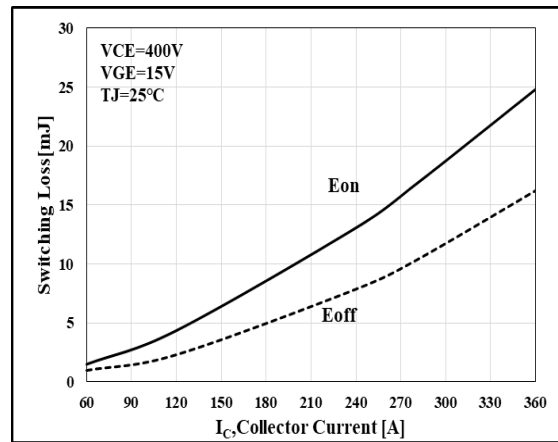

Figure 12. Switching Loss- I_c Characteristics

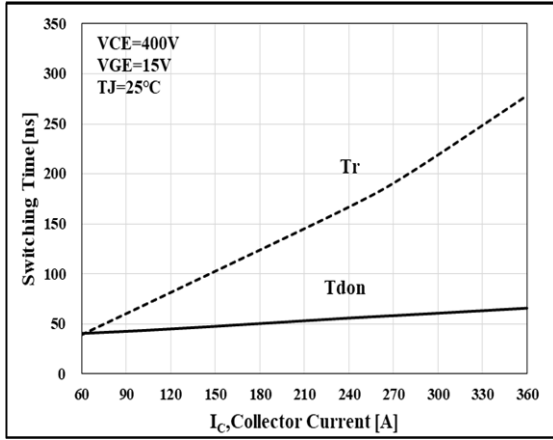

Figure 13.Switching Time- I_C Characteristics

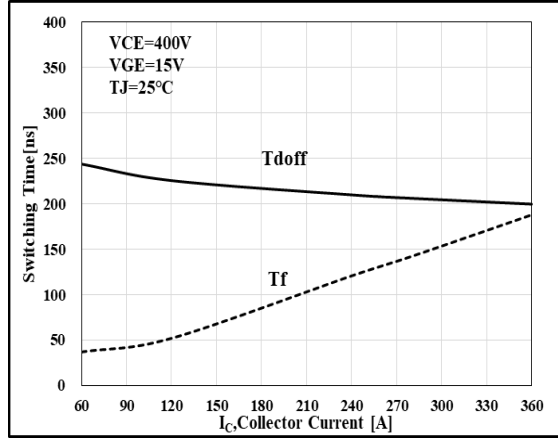

Figure 14.Switching Time- I_C Characteristics

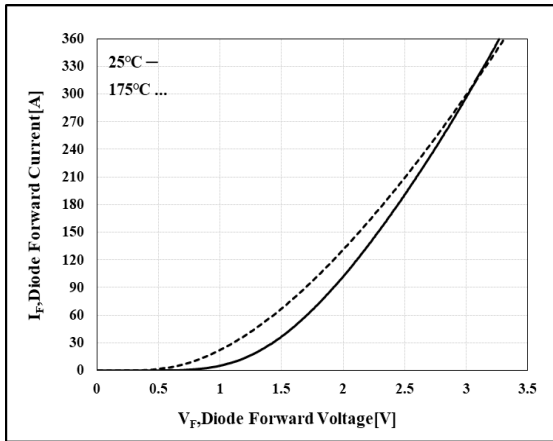

Figure 15.Diode Forward Characteristics

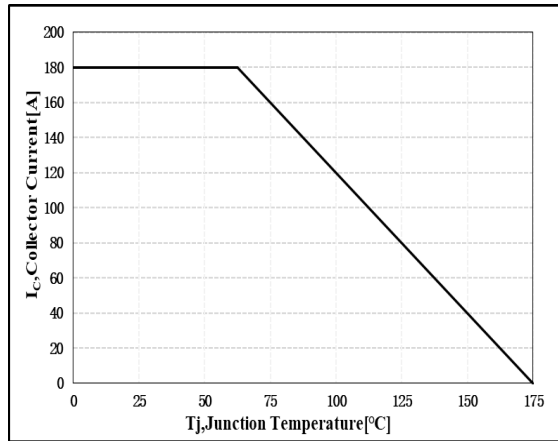

Figure 16.Collector Current- T_j Characteristics

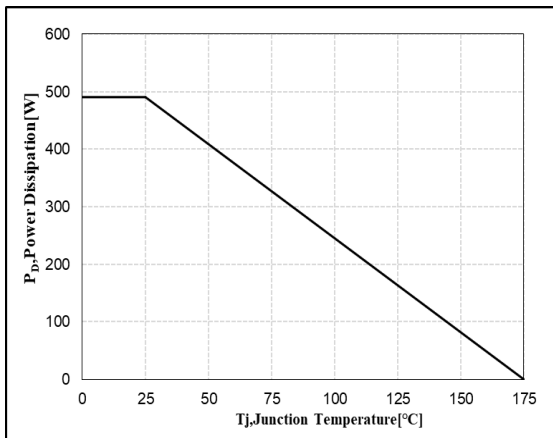

Figure 17.Power dissipation

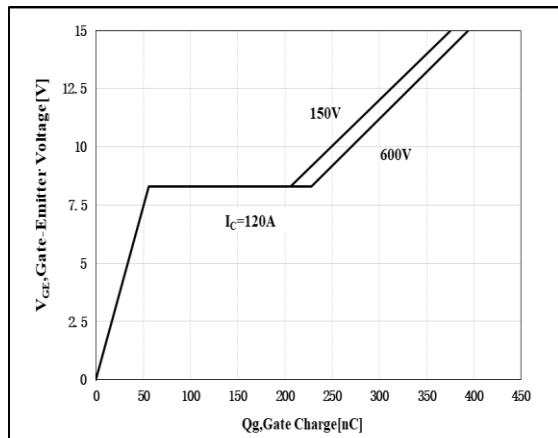

Figure 18.Gate Charge Characteristics

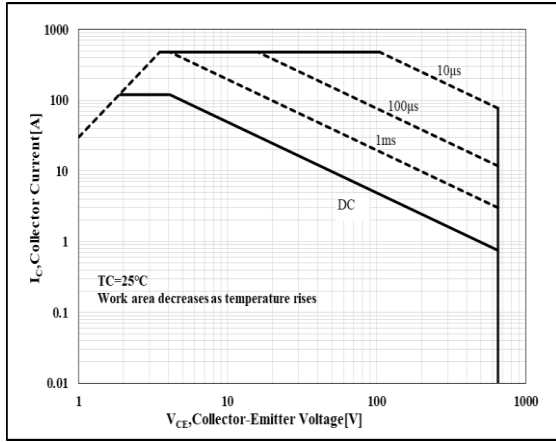

Figure 19. Forward Bias Safe Operating Area

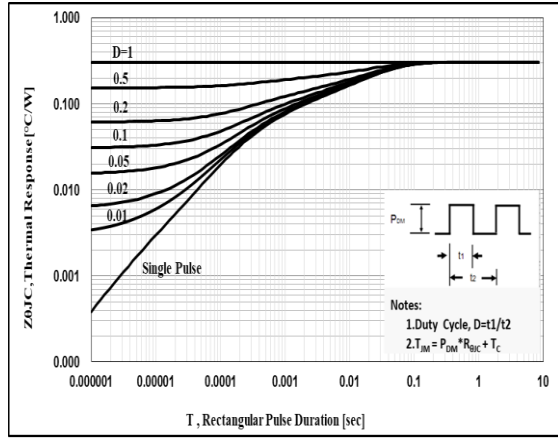
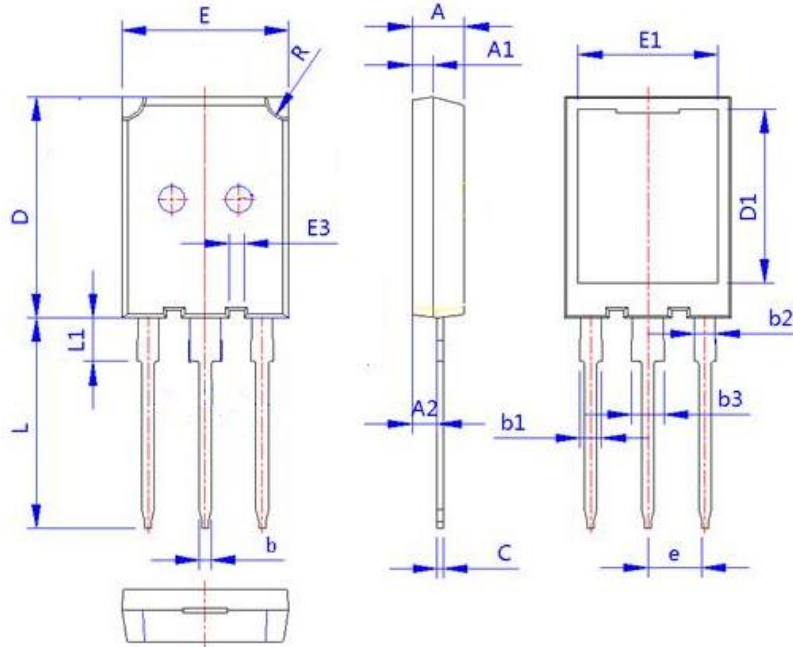

Figure 20. IGBT Transient Thermal Impedance

Package Information



项 目	规范(mm)	
	MIN	MAX
A	4.85	5.15
A1	1.85	2.15
A2	2.15	2.65
b	1.07	1.33
b1	1.90	2.46
b2	1.90	2.16
b3	2.82	3.43
C	0.55	0.70
D	20.75	21.15
D1	16.20	16.90
E	15.50	16.10
E1	13.01	13.51
E3	1.25	1.65
e	5.44 (BSC)	
R	1.80	2.20
L	19.60	20.40
L1	4.00	4.48

TO-247Plus Package

The name and content of poisonous and harmful material in products

Part's Name	Hazardous Substance									
	Pb	Hg	Cd	Cr(VI)	PBB	PBDE	DIBP	DEHP	DBP	BBP
Limit	≤0.1%	≤0.1%	≤0.01 %	≤0.1%	≤0.1%	≤0.1%	≤0.1%	≤0.1%	≤0.1%	≤0.1%
Lead Frame	○	○	○	○	○	○	○	○	○	○
Molding	○	○	○	○	○	○	○	○	○	○
Chip	○	○	○	○	○	○	○	○	○	○
Wire Bonding	○	○	○	○	○	○	○	○	○	○
Solder	×	○	○	○	○	○	○	○	○	○
Note	○: Means the hazardous material is under the criterion of 2011/65/EU. ×: Means the hazardous material exceeds the criterion of 2011/65/EU. The plumbum element of solder exist in products presently, but within the allowed range of Eurogroup's RoHS.									

Warnings

1. Exceeding the maximum ratings of the device in performance may cause damage to the device, even the permanent failure, which may affect the dependability of the machine. It is suggested to be used under 80 percent of the maximum ratings of the device.
2. When installing the heat sink, please pay attention to the torsional moment and the smoothness of the heat sink.
3. IGBTs is the device which is sensitive to the static electricity, it is necessary to protect the device from being damaged by the static electricity when using it.
4. This publication is made by Huajing Microelectronics and subject to regular change without notice.

WUXI CHINA RESOURCES HUAJING MICROELECTRONICS CO., LTD.

Add: No.14 Liangxi RD. Wuxi, Jiangsu, China **Mail:** 214061 <https://www.crmicro.com>
Tel: 0510-85807228 **Fax:** 0510-85800864

Marketing Part: **Post:** 214061 **Tel / Fax:** 0510-85807228-3663/5508
0510-85800360 (Fax)

Application and Service: **Post:** 214061 **Tel / Fax:** 0510-85807228-3399 / 2227



Modify :

Version	Modify record
2025V01	Initial release