

AMGP-6551

40.5 – 43.5 GHz SMT Packaged Up-Converter

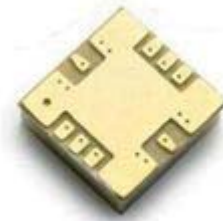

Data Sheet



Description

The AMGP-6551 is a surface mount packaged broadband Up-converter that combines a sub-harmonic, SSB mixer with a variable gain amplifier. It is designed for use at frequencies between 37.5 GHz and 43.5 GHz and provides 10 dB of conversion gain with >20 dB gain control dynamic range. This Up-converter required +20 dBm LO drive level, and it supports IF from DC to 3 GHz. OIP3 of +20 and +16 dBm are achieved at 40.5 and 43.5 GHz respectively.

Functional Block Diagram

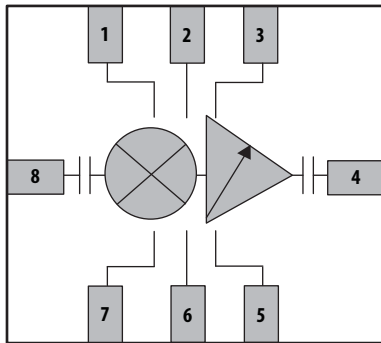

Pin	Function
1	IF1
2	Vd1
3	IF2
4	RF_OUT
5	Vd3
6	Vc
7	Vd2
8	RF_IN

Features

- 5 x 5 mm surface mount package
- RF frequency range from 40.5 to 43.5 GHz
- LO frequency range from 18.5 to 23.5 GHz
- IF frequency range from DC to 3 GHz
- +20 dBm LO driver power
- 10 dB Conversion Gain
- 20 dB Dynamic Range
- +20 dBm Output IP3 @ 40.5 GHz, and +16 dBm @ 43.5 GHz
- Vdd = 3.5 V and Idd = 300 mA
- 1 to 0 V Control voltage (Vc)

Application

- Microwave Radio Systems

Package Diagram

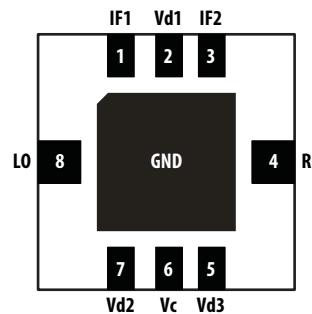

Attention: Observe Precautions for handling electrostatic sensitive devices.
ESD Machine Model: 30 V
ESD Human Body Model: 150 V
Refer to Avago Application Note A004R:
Electrostatic Discharge Damage and Control.

ELECTRICAL SPECIFICATIONS

Table 1. Absolute Minimum and Maximum Ratings

Parameter		Specifications			Comments
Description		Min.	Max.	Unit	
Supply Voltage	Vd		5	V	
Control Voltage	Vc	-3	+1.5	V	
LO Input Power	LO		24	dBm	
MSL			MSL2A		
Channel Temperature			150	°C	
Storage Temperature		-45	150	°C	

Table 2. Recommended Operating Range

Parameter		Specifications				Comments
Description	Pin	Min.	Typical	Max.	Unit	
Supply Voltage	Vd	3.0	3.5	4.0	V	
Control Voltage	Vc	-1		0	V	Vc = -1 V for Max. Gain Vc = 0 V for Min. Gain
Frequency Range	RF	40.5		43.5	GHz	
	LO	18.5		23.5		
	IF	DC		3		
LO Power		+18	+20	+22	dBm	
Bias Current			300		mA	
Thermal Resistance, θ_{ch-b}			18.8		°C/W	
Case Temperature		-40		+85	°C	
ESD	Human Body Model		150		V	HBM Class 0 is ESD < 250 V
	Machine Model		< 30		V	MM Class A is ESD < 200 V This product is highly sensitive to esd damage

Table 3. RF Electrical Characteristics

All data measured on Connectorized Taconic RF-35A2 demo board at Vd = 5 V, TA = 25° C, IF = 1.8 GHz @ -10 dBm, LO = +20 dBm, Upper Side Band (RF = IF + 2*LO) and 50 Ω at all ports, unless otherwise specified.

Return Loss measurement includes effect of connector + PCB.

Parameter		Performance (40.5 – 43.5 GHz)			Unit	Comments
		Min.	Typ.	Max.		
Max. Conversion Gain	RF = 40.5 GHz	8	10.79		dB	(@ Vc = -1 V)
	RF = 42 GHz		12.07			
	RF = 43.5 GHz		9.87			
Gain Dynamic Range			24		dB	
Input IP3	RF = 40.5 GHz	+4.5	8.99		dBm	Δ IF = 10 MHz, IF Input -10 dBm/Tone
	RF = 42 GHz		5.18			
	RF = 43.5 GHz		9.59			
Sideband REjection			15		dBc	In max gain state
LO-RF Isolation			15		dB	
2*LO Leak. @RF Port			10		dBc	
RF Return Loss			12		dB	
IF Return Loss			12		dB	
LO Return Loss			8		dB	

Product Consistency Distribution Charts at 40.5 GHz, 42 GHz and 43.5 GHz, Vdd = 5 V, VC = -1 V, LO = 21 dBm, IF = -5 dBm (Sample size of 2,000 pieces)

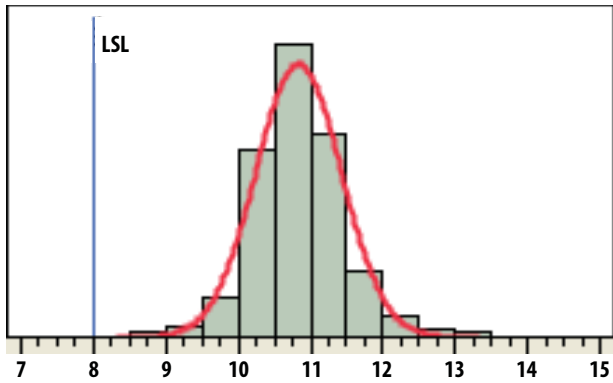

CV Gain @ 40.5 GHz, Mean = 10.79 dB, LSL = 8 dB

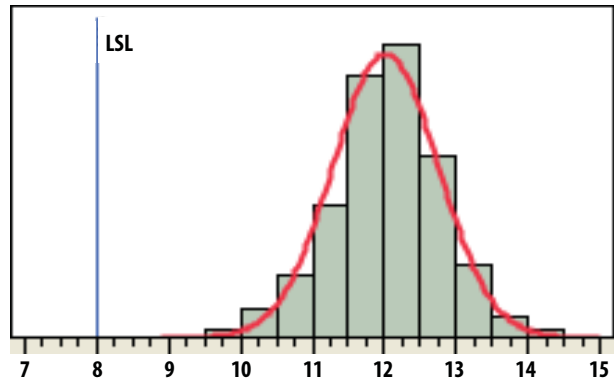

CV Gain @ 42 GHz, Mean = 12.07 d, LSL = 8 dB

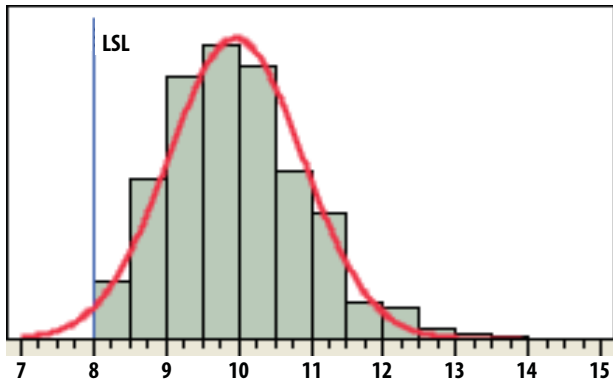

CV Gain @ 43.5 GHz, Mean = 9.87 dB, LSL = 8 dB

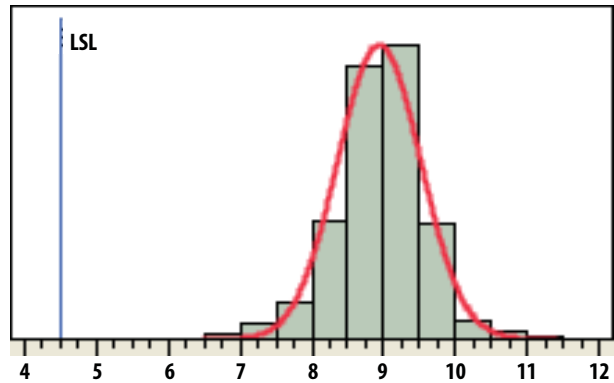

IIP3 @ 40.5 GHz, Mean = 8.99 dBm, LSL = 4.5 dBm

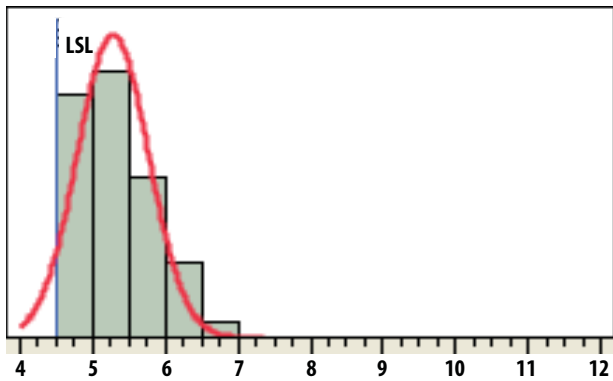

IIP3 @ 42 GHz, Mean = 5.18 dBm, LSL = 4.5 dBm

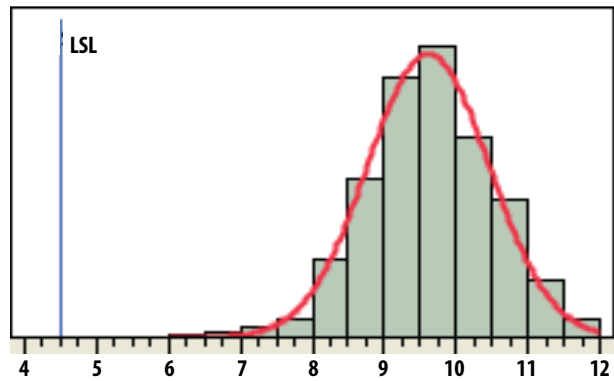

IIP3 @ 43.5 GHz, Mean = 9.59 dBm, LSL = 4.5 dBm

Selected performance plots

All data measured on Connectorized Taconic RF-35A2 demo board at $V_d = 5\text{ V}$, $T_A = 25^\circ\text{ C}$, $IF = 1.8\text{ GHz @ } -10\text{ dBm}$, $LO = +20\text{ dBm}$, Upper Side Band ($RF = IF + 2*LO$) and $50\ \Omega$ at all ports, unless otherwise specified.

Return Loss measurement includes effect of connector + PCB.

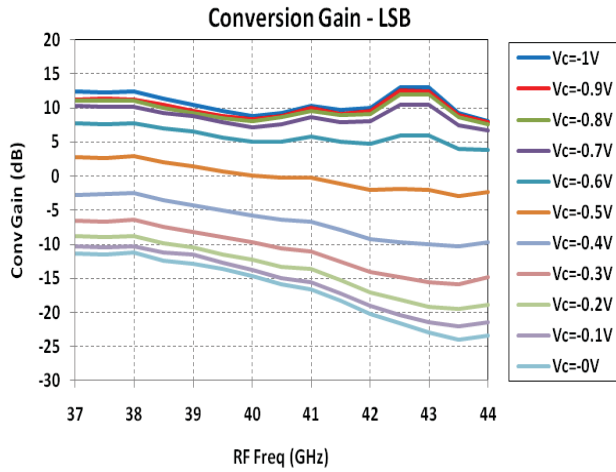

Figure 1. LSB Conversion Gain vs Control Voltage

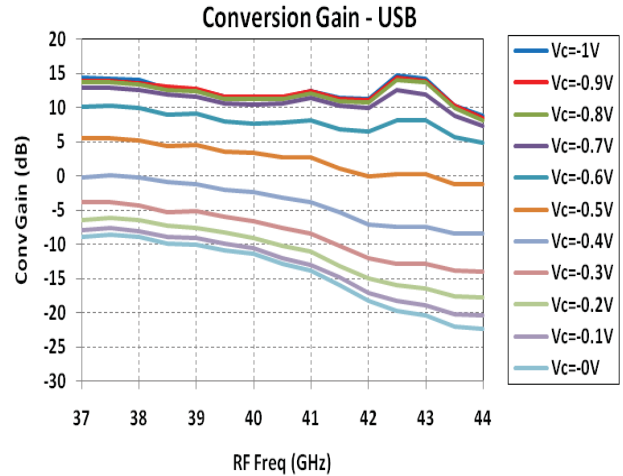

Figure 2. USB Conversion Gain vs Control Voltage

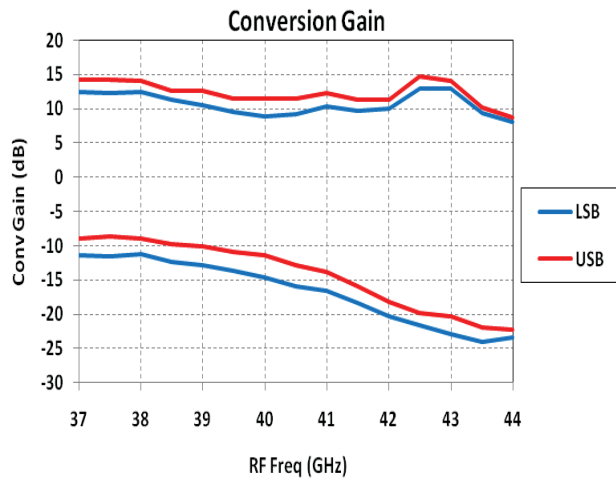

Figure 3. Conversion Gain (max and min gain)

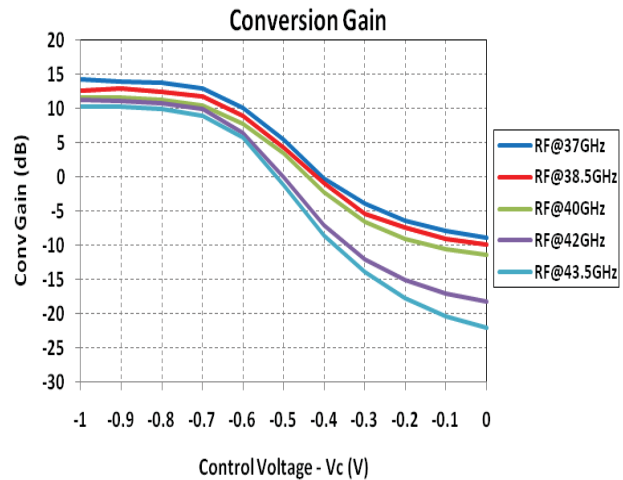

Figure 4. Conversion Gain vs. Control Voltage

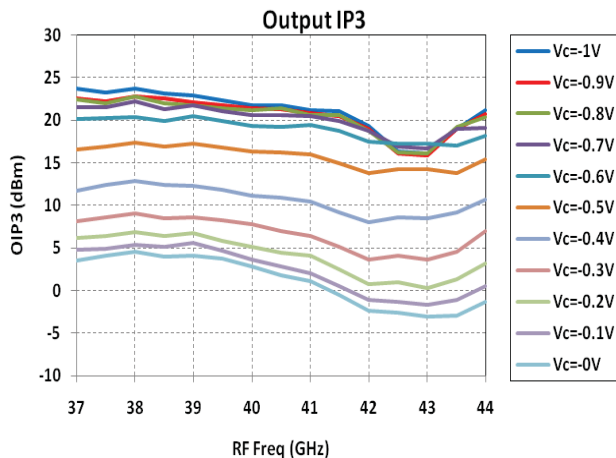

Figure 5. LSB Output IP3 vs Control Voltage

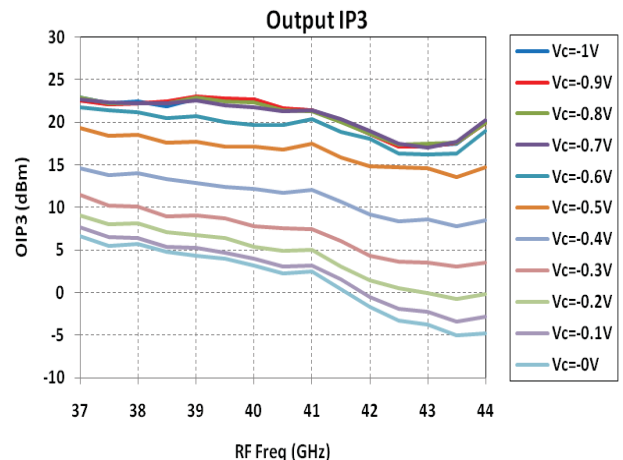

Figure 6. USB Output IP3 vs Control Voltage

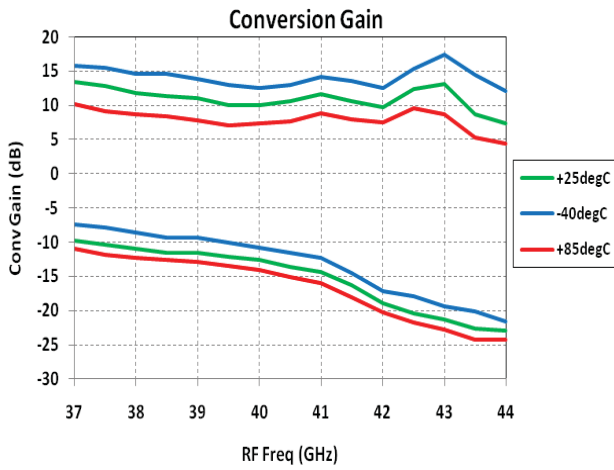

Figure 7. USB Conversion Gain vs Temperature (min and max gain)

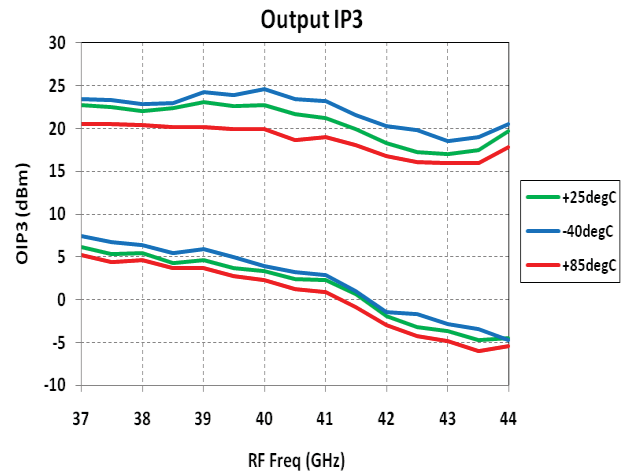

Figure 8. USB Output IP3 vs Temperature (min and max gain)

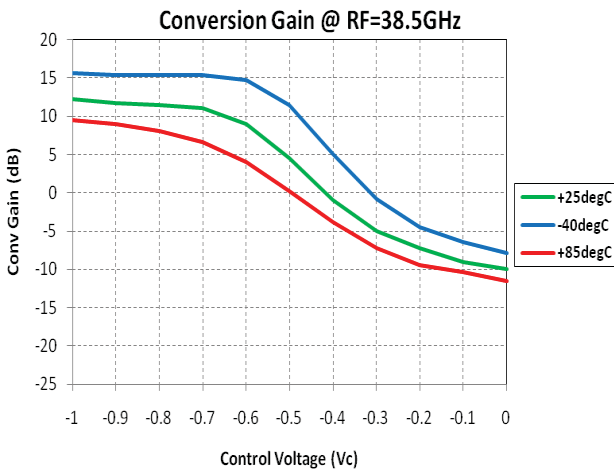

Figure 9. USB Conversion Gain vs. Temperature at 38.5 GHz

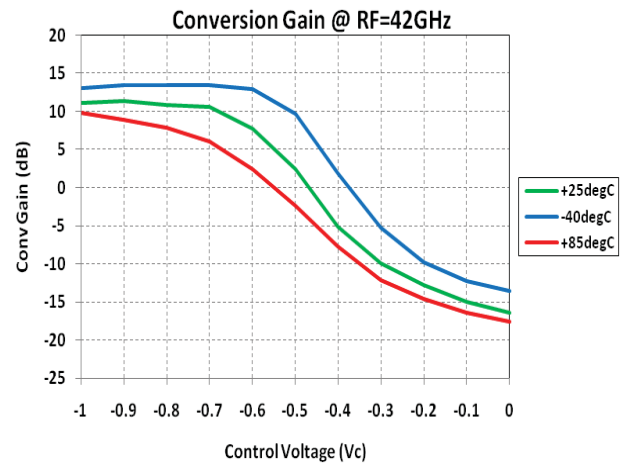

Figure 10. USB Conversion Gain vs. Temperature at 42 GHz

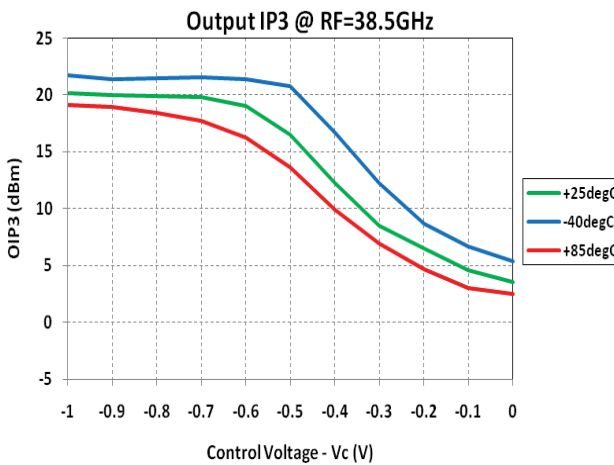

Figure 11. USB Output IP3 vs. Temperature at 38.5 GHz

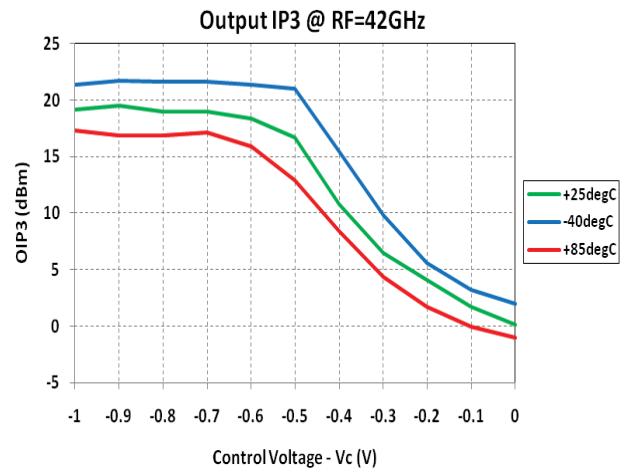

Figure 12. USB Output IP3 vs. Temperature at 42 GHz

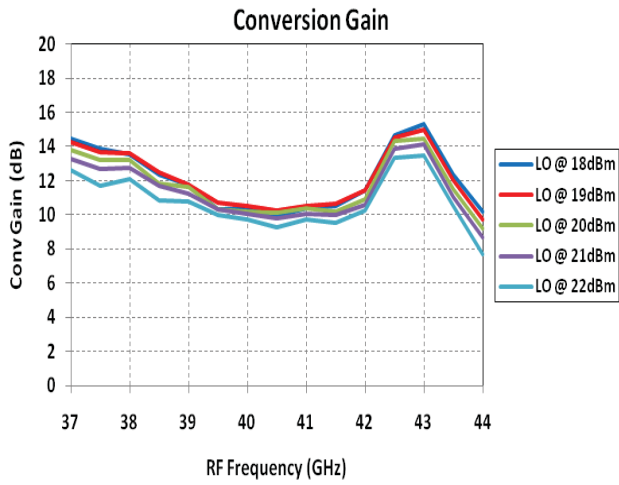

Figure 13. USB Conversion Gain @ LO = 18-22 dBm with $V_c = -1$ V

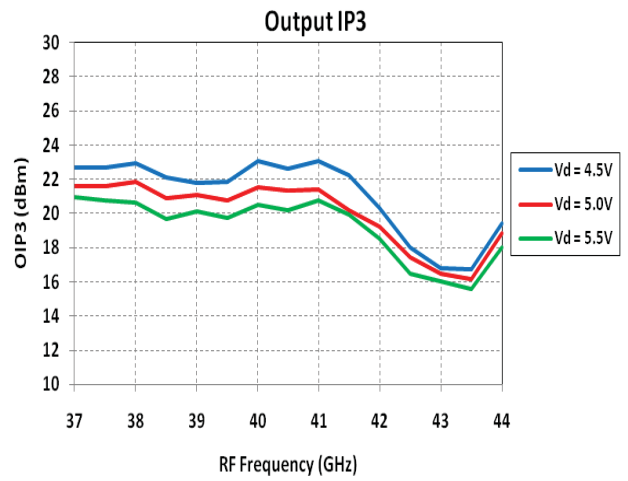

Figure 14. USB Output IP3 vs RF Freq. @ $V_d = 4.5$ - 5.5 V step 0,5 V

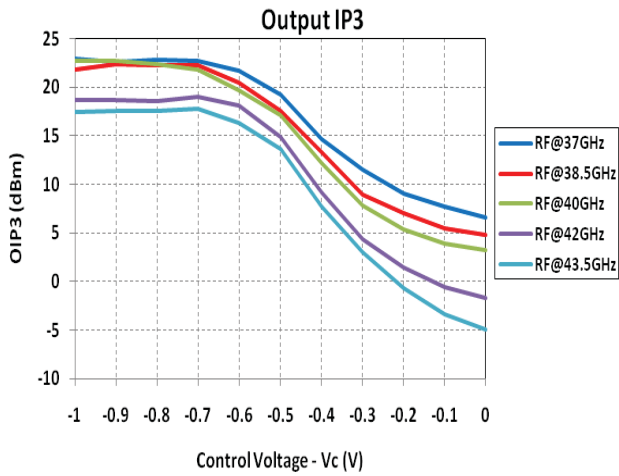

Figure 15. USB OIP3 vs. Control Voltage (V_c) with RF = 37-43.5 GHz

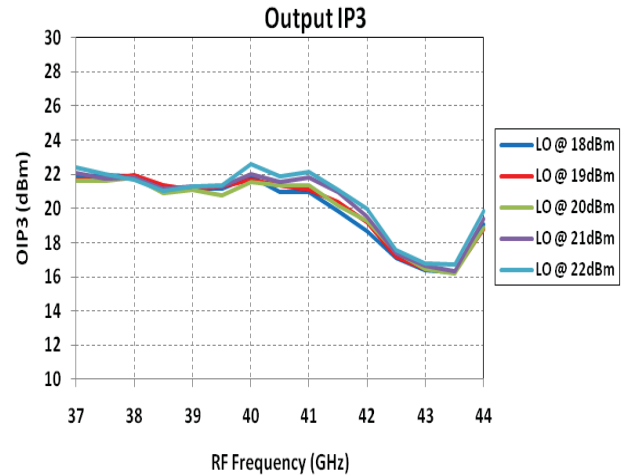

Figure 16. USB Output IP3 vs. RF Freq. @ LO = 18-22 dBm with $V_c = -1$ V

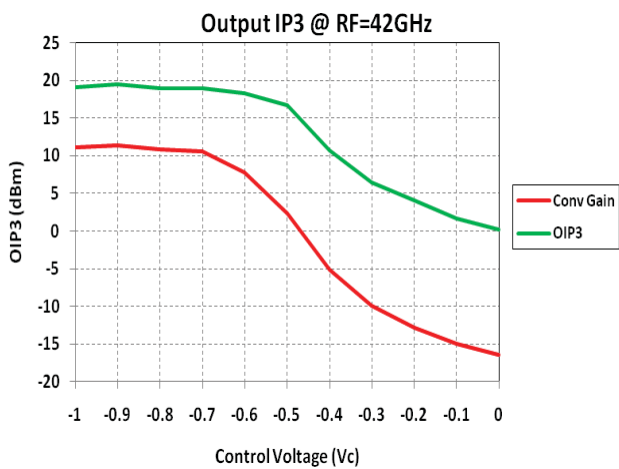

Figure 17. USB Output IP3 & Conversion gain vs. Control Voltage

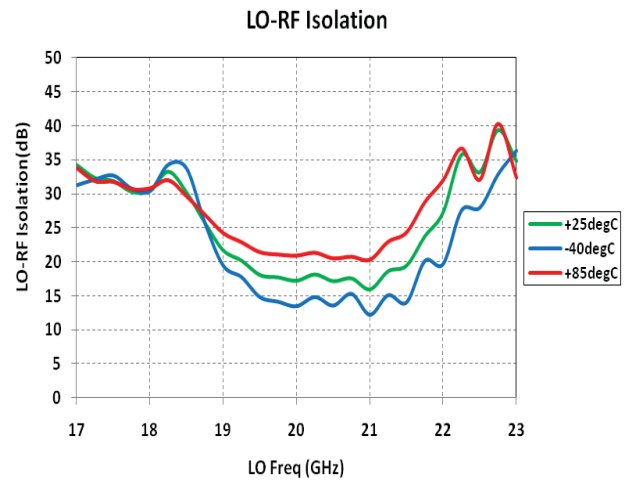

Figure 18. Over Temp. LO Rejection @ RF-port

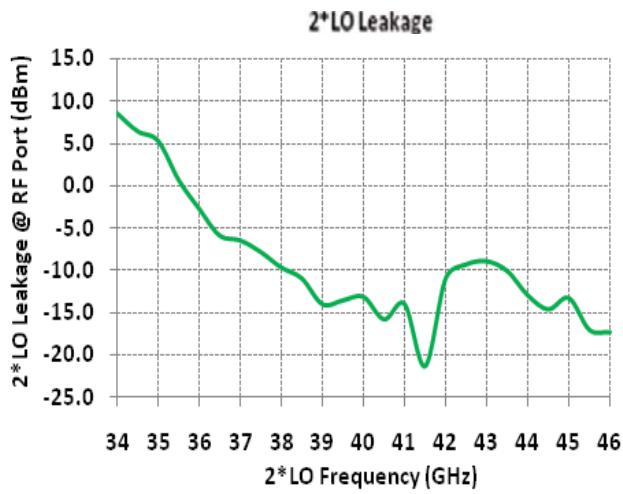

Figure 19. 2*LO Rejection @ RF-port

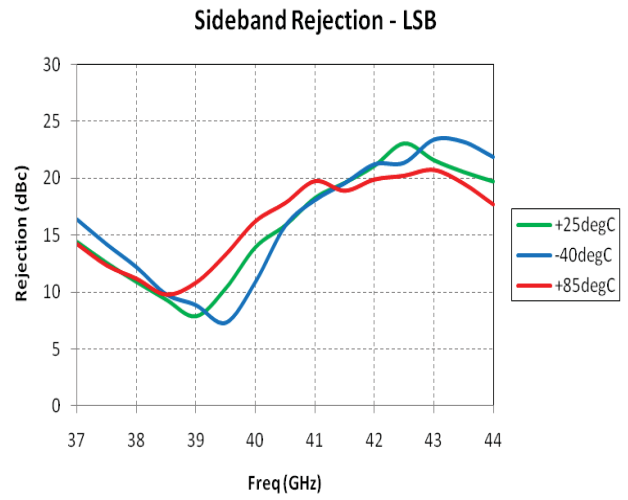

Figure 20. USB Sideband Rejection at 25° C

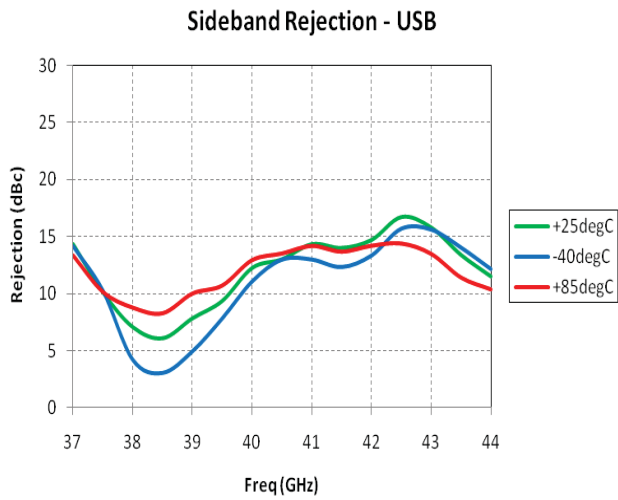

Figure 21. LSB Sideband Rejection at 25° C

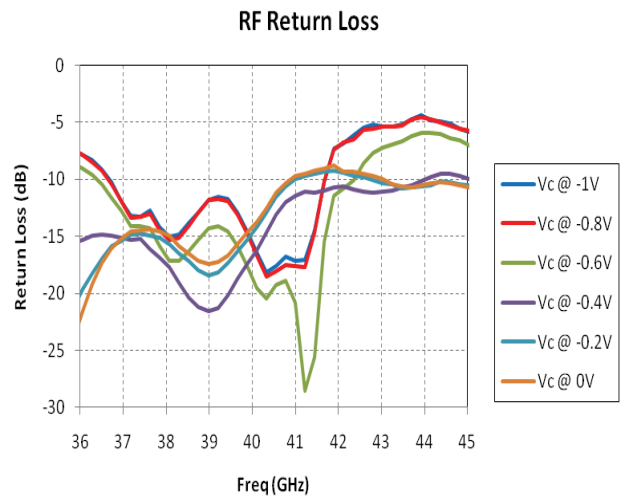

Figure 22. RF Output Return Loss vs. Control Voltage @ 25° C

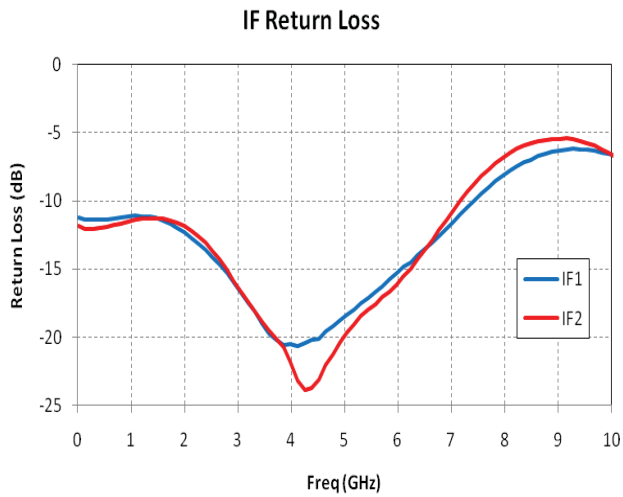

Figure 23. IF Input Return Loss vs. Frequency

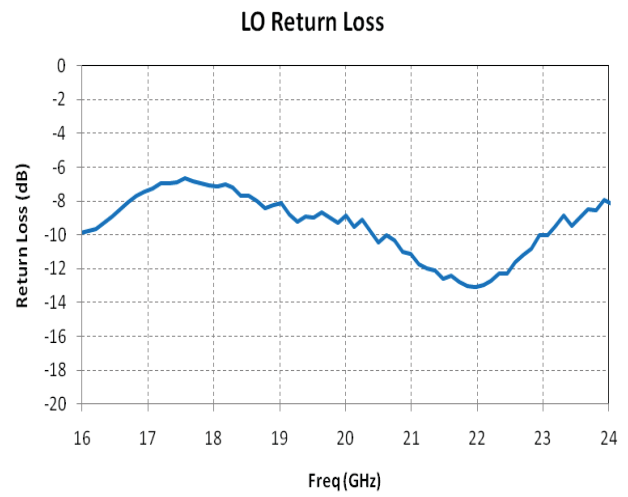

Figure 24. LO Input Return Loss with LO = +20 dBm

Evaluation Board Description

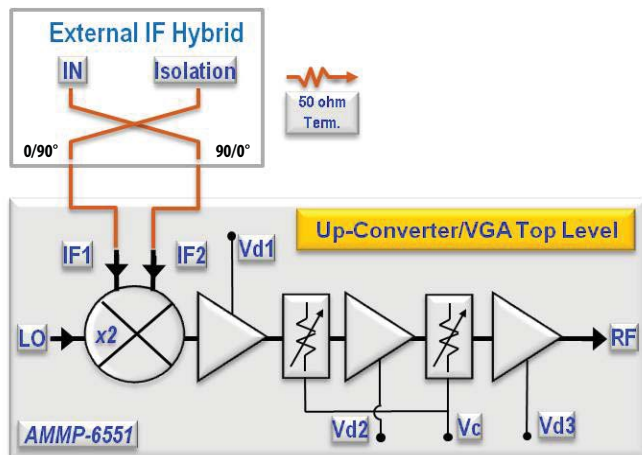
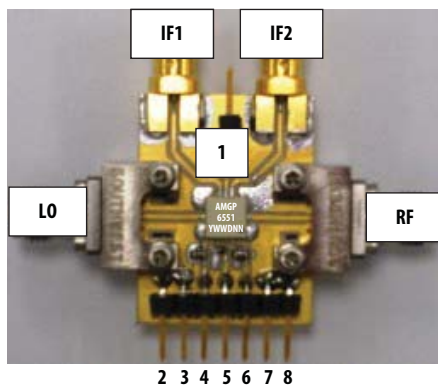

Table 4. Pin Description

Pin #	Function	Typical	Comment
1	Vd1	3.5	100 mA
2	GND		
3	GND		
4	Vd2	3.5	100 mA
5	Vc	-1 to 0 V	< 1 mA
6	Vd3	3.5	100 mA
7	GND		
8	GND		

Demo board circuit



Notes:

1. IF can be applied to either IN or Isolation port of a passive Hybrid.
2. If IF is applied to IN port, terminate Isolation port with 50 ohm
3. If IF is applied to Isolation port, terminate IN port with 50 ohm
4. Switching the IF input from In port to Isolation port or vice versa RF can be switched to LSB or USB

Package Dimension, PCB Layout and Tape and Reel information

Please refer to Avago Technologies Application Note 5521, AMxP-xxxx production Assembly Process (Land Pattern B).

Part Number Ordering Information

Part Number	Devices per Container	Container
AMGP-6551-BLKG	10	antistatic bag
AMGP-6551-TR1G	100	7" Reel
AMGP-6551-TR2G	500	7" Reel

For product information and a complete list of distributors, please go to our web site: www.avagotech.com

Avago, Avago Technologies, and the A logo are trademarks of Avago Technologies in the United States and other countries. Data subject to change. Copyright © 2005-2012 Avago Technologies. All rights reserved. AV02-3211EN - May 10, 2012

AVAGO
TECHNOLOGIES