

2MBI450VJ-120-50

IGBT Modules

IGBT MODULE (V series) 1200V / 450A / 2 in one package

■ Features

- High speed switching
- Voltage drive
- Low Inductance module structure

■ Applications

- Inverter for Motor Drive
- AC and DC Servo Drive Amplifier
- Uninterruptible Power Supply
- Industrial machines, such as Welding machines



■ Maximum Ratings and Characteristics

● Absolute Maximum Ratings (at Tc=25°C unless otherwise specified)

Items	Symbols	Conditions	Maximum ratings	Units	
Inverter	Collector-Emitter voltage	V _{CEs}	1200	V	
	Gate-Emitter voltage	V _{GES}	±20	V	
	Collector current	I _c	Continuous Tc=80°C	450	A
		I _c pulse	1ms Tc=80°C	900	
		-I _c		450	
		-I _c pulse	1ms	900	
Collector power dissipation	P _c	1 device	2270	W	
Junction temperature	T _j		175	°C	
Operating junction temperature (under switching conditions)	T _{jop}		150		
Case temperature	T _c		125		
Storage temperature	T _{stg}		-40 to +125		
Isolation voltage	between terminal and copper base (*1)	V _{iso}	AC : 1min.	2500	VAC
	between thermistor and others (*2)				
Screw torque	Mounting (*3)		3.5	N m	
	Terminals (*4)		4.5		
	PC-Board (*5)		0.6		

Note *1: All terminals should be connected together during the test.

Note *2: Two thermistor terminals should be connected together, other terminals should be connected together and shorted to base plate during the test.

Note *3: Recommendable value : 2.5-3.5 Nm (M5) Note *4: Recommendable value : 3.5-4.5 Nm (M6)

Note *5: Recommendable value : 0.4-0.6 Nm (M2.5)

● Electrical characteristics (at Tj= 25°C unless otherwise specified)

Items	Symbols	Conditions	Characteristics			Units	
			min.	typ.	max.		
Zero gate voltage collector current	I _{CEs}	V _{GE} = 0V, V _{CE} = 1200V	-	-	3.0	mA	
Gate-Emitter leakage current	I _{GES}	V _{GE} = 0V, V _{CE} = ±20V	-	-	600	nA	
Gate-Emitter threshold voltage	V _{GE(th)}	V _{CE} = 20V, I _c = 450mA	6.0	6.5	7.0	V	
Collector-Emitter saturation voltage	V _{CE(sat)} (terminal)	V _{GE} = 15V I _c = 450A	Tj=25°C	-	2.25	2.70	V
			Tj=125°C	-	2.55	-	
			Tj=150°C	-	2.60	-	
	V _{CE(sat)} (chip)		Tj=25°C	-	1.75	2.20	
			Tj=125°C	-	2.05	-	
			Tj=150°C	-	2.10	-	
Input capacitance	C _{ies}	V _{CE} = 10V, V _{GE} = 0V, f = 1MHz	-	41	-	nF	
Turn-on time	t _{on}	V _{CC} = 600V I _c = 450A	-	550	1200	nsec	
	t _r		-	180	600		
	t _{r(i)}		-	120	-		
Turn-off time	t _{off}	V _{GE} = ±15V R _G = 0.52Ω	-	1050	2000	nsec	
	t _f		-	110	350		
			-	110	350		
Forward on voltage	V _F (terminal)	V _{GE} = 0V I _F = 450A	Tj=25°C	-	2.20	2.65	V
			Tj=125°C	-	2.35	-	
			Tj=150°C	-	2.30	-	
	V _F (chip)		Tj=25°C	-	1.70	2.15	
			Tj=125°C	-	1.85	-	
			Tj=150°C	-	1.80	-	
Reverse recovery time	t _{rr}	I _F = 450A	-	200	600	nsec	
Thermistor	Resistance	T=25°C	-	5000	-	Ω	
		T=100°C	465	495	520		
		T=25/50°C	3305	3375	3450		
B value	B	T=25/50°C	3305	3375	3450	K	

● Thermal resistance characteristics

Items	Symbols	Conditions	Characteristics			Units
			min.	typ.	max.	
Thermal resistance (1device)	R _{th(j-c)}	Inverter IGBT	-	-	0.066	°C/W
		Inverter FWD	-	-	0.100	
Contact thermal resistance (1device) (*6)	R _{th(c-f)}	with Thermal Compound	-	0.0167	-	

Note *6: This is the value which is defined mounting on the additional cooling fin with thermal compound.

■ Characteristics (Representative)

[INVERTER]

Collector current vs. Collector-Emmitter voltage (typ.)
T_j = 25°C / chip

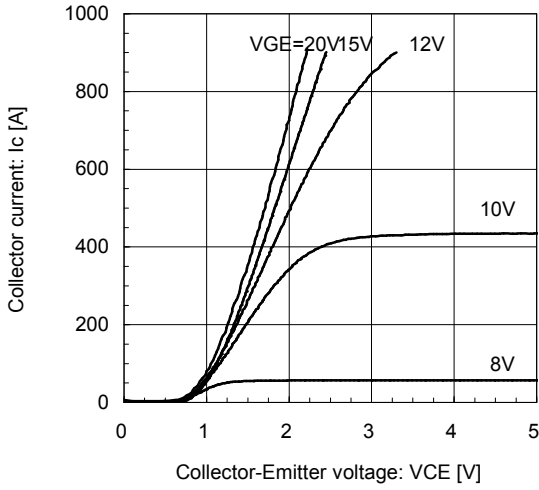

[INVERTER]

Collector current vs. Collector-Emmitter voltage (typ.)
T_j = 150°C / chip

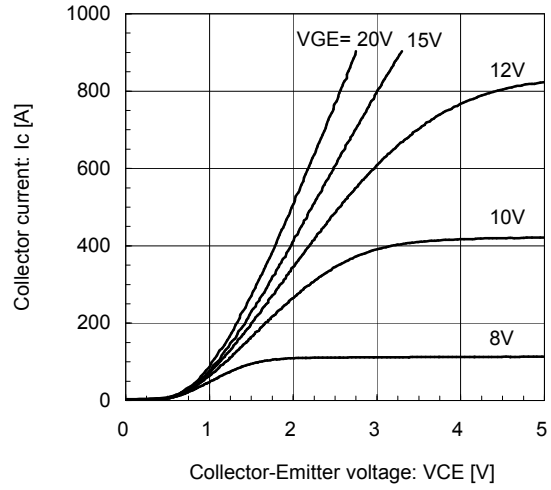

[INVERTER]

Collector current vs. Collector-Emmitter voltage (typ.)
VGE = 15V / chip

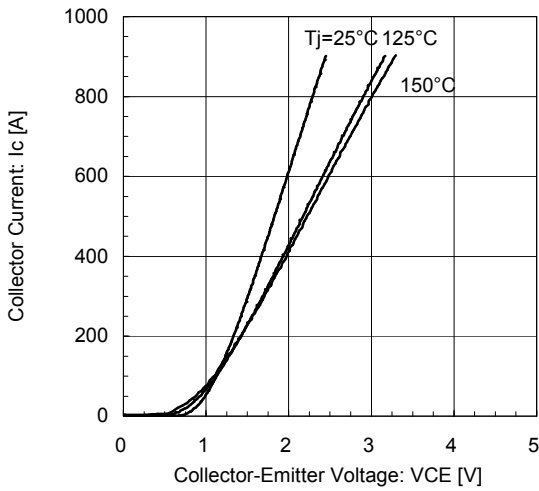

[INVERTER]

Collector-Emmitter voltage vs. Gate-Emmitter voltage (typ.)
T_j = 25°C / chip

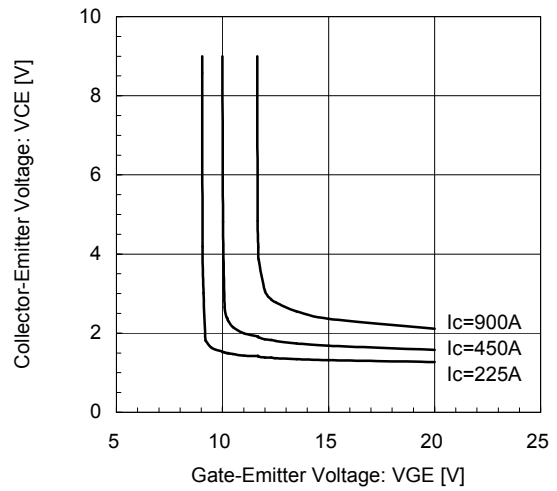

[INVERTER]

Gate Capacitance vs. Collector-Emmitter Voltage (typ.)
VGE = 0V, f = 1MHz, T_j = 25°C

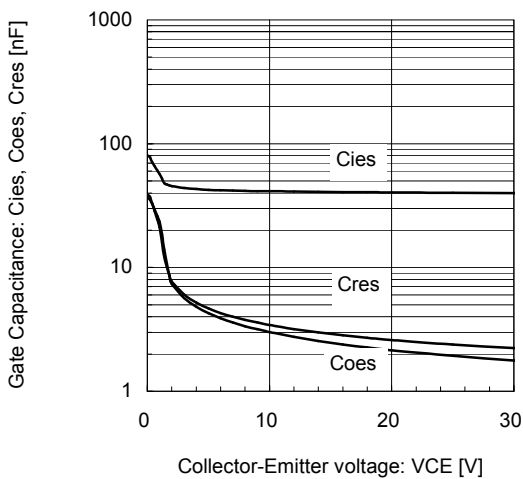

[INVERTER]

Dynamic Gate Charge (typ.)
Vcc = 600V, Ic = 450A, T_j = 25°C

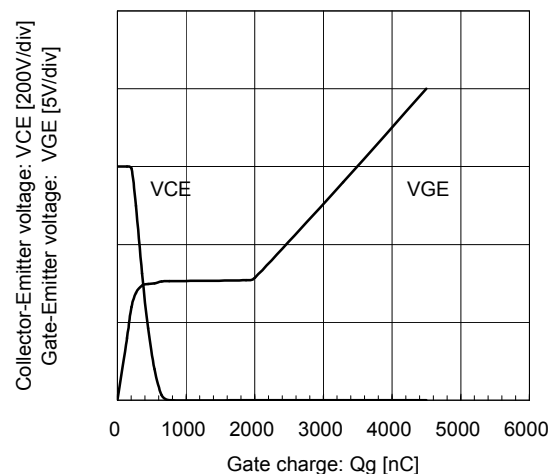

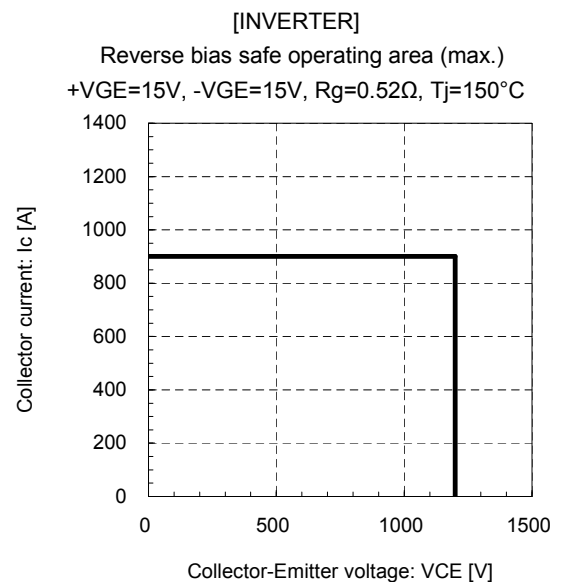
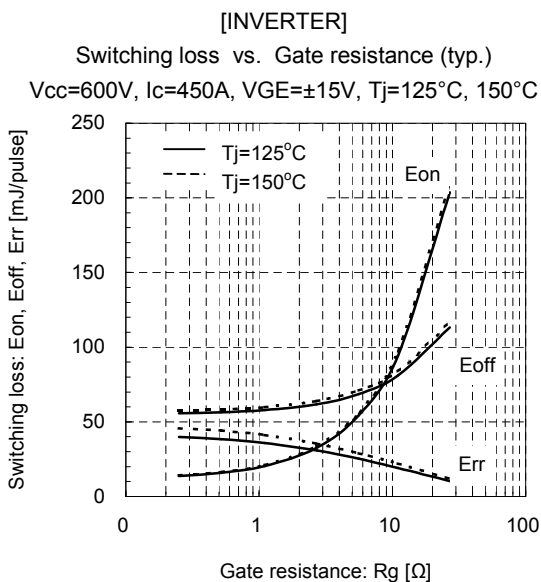
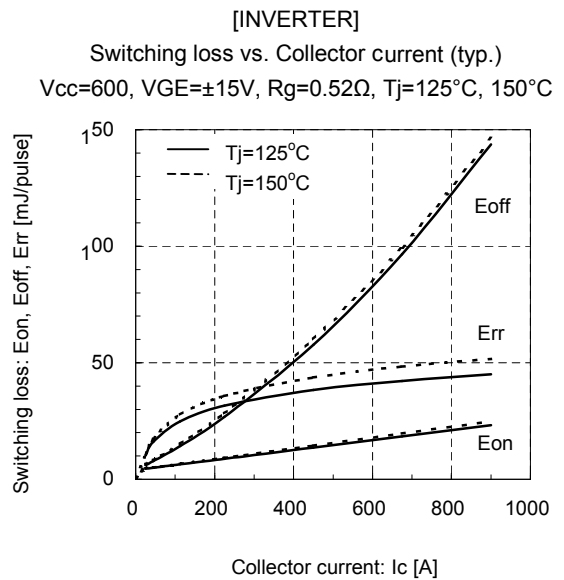
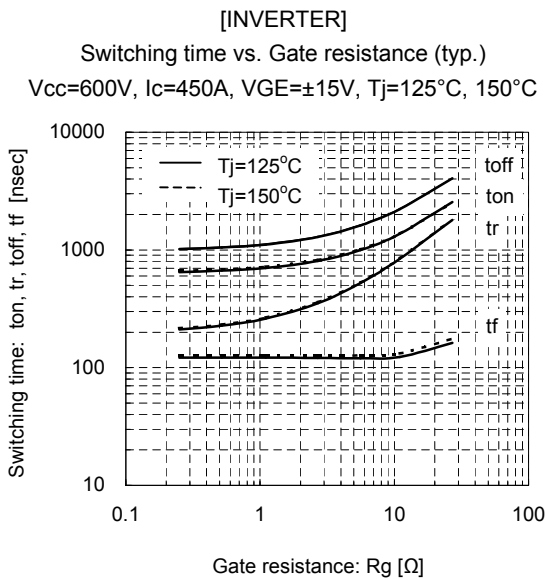
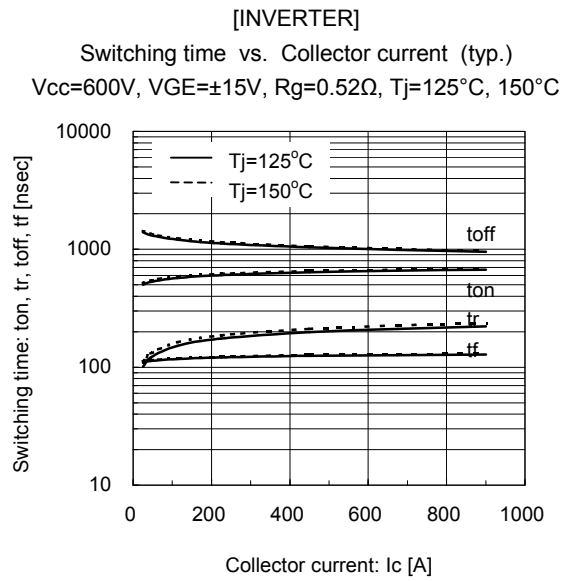
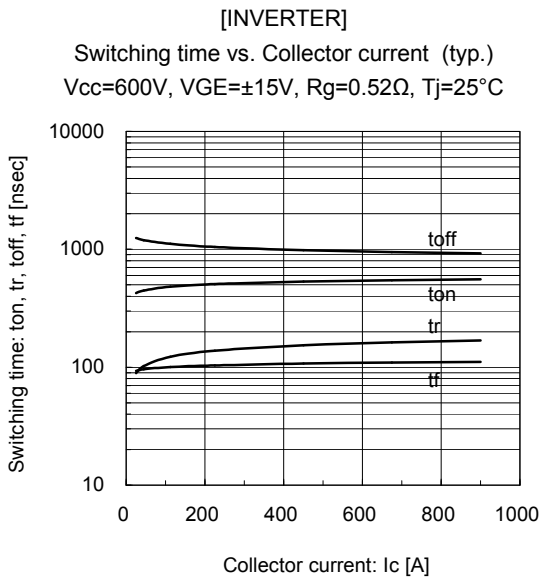

[INVERTER]

Forward Current vs. Forward Voltage (typ.)
chip

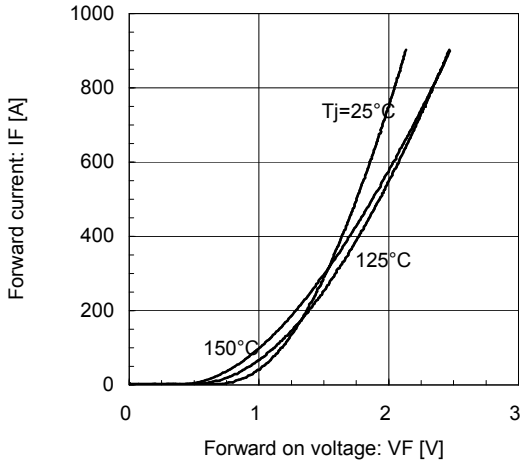

[INVERTER]

Reverse Recovery Characteristics (typ.)
Vcc=600V, VGE=±15V, Rg=0.52Ω, Tj=25°C

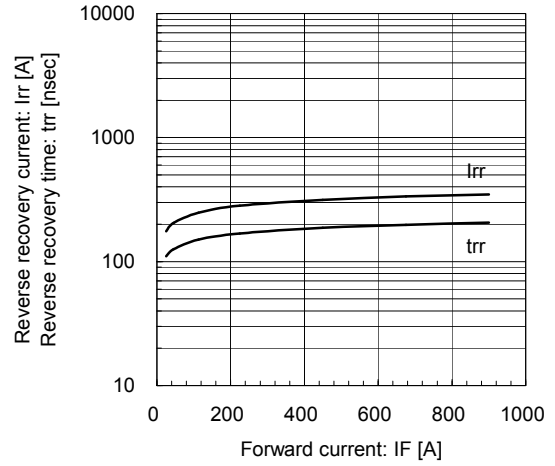

[INVERTER]

Reverse Recovery Characteristics (typ.)
Vcc=600V, VGE=±15V, Rg=0.52Ω, Tj=125°C, 150°C

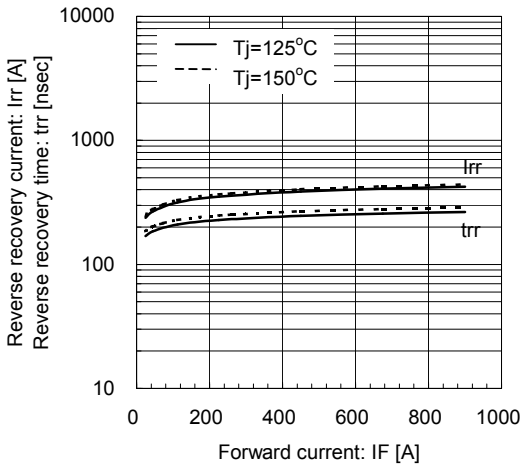

Transient Thermal Resistance (max.)

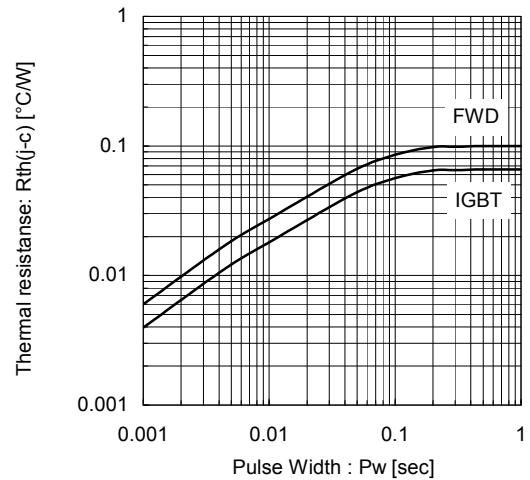

[THERMISTOR]

Temperature characteristic (typ.)

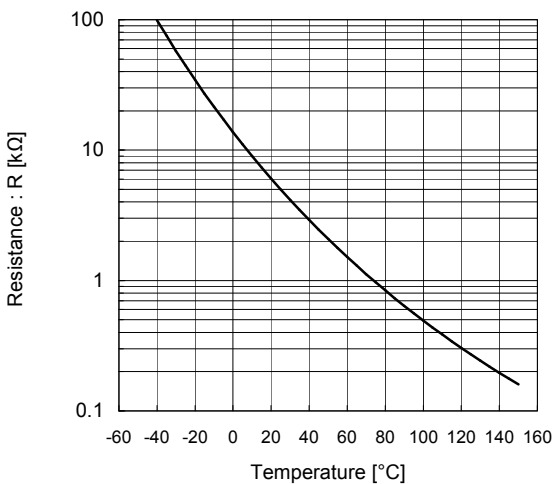

Outline Drawings, mm

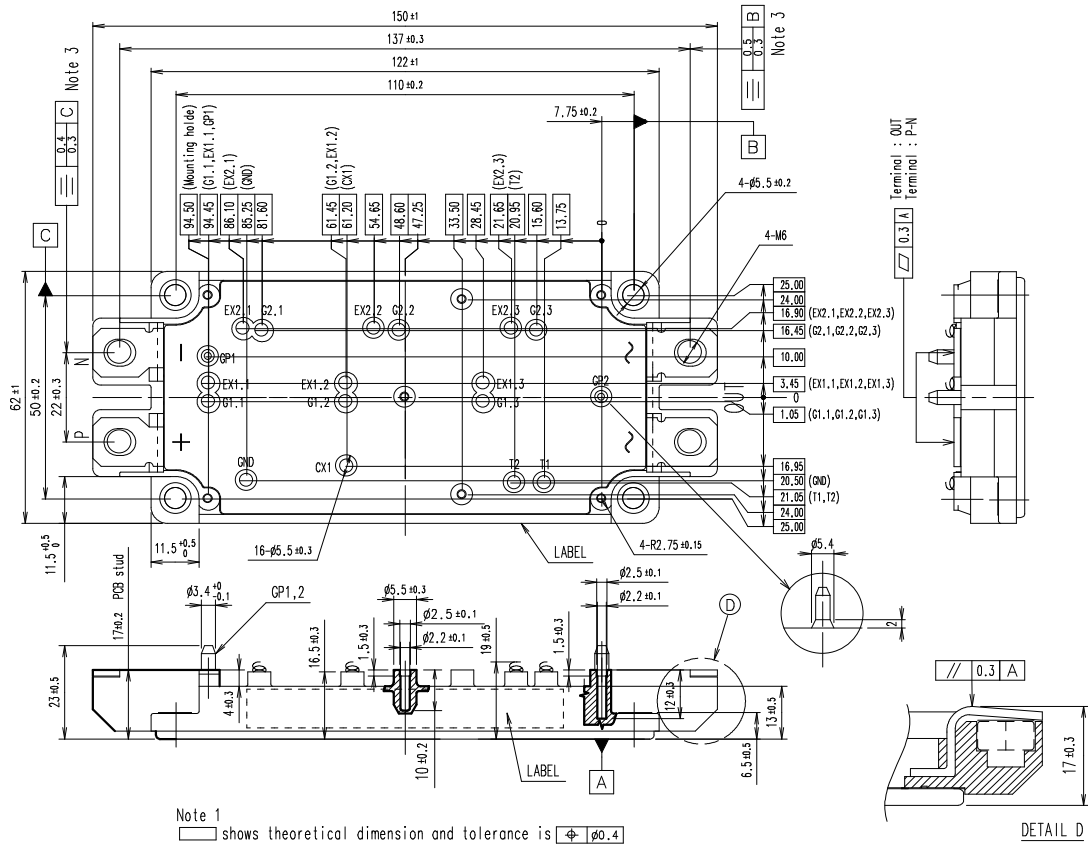

Note 1
 shows theoretical dimension and tolerance is $\phi \pm 0.4$

Note 2
 Rule for PCB
 · Guide pin hole : $\phi 4.0 \pm 0.1$
 · Guide pin distance : 94.45 ± 0.1
 · Spring contact pad : $\phi 3.8 \pm 0.2$
 · Position tol.pad : $\phi \pm 0.4$

Note 3

 Upper value : Terminal hole center
 Lower value : Nut center
 (Including margin of the nut position.)

Equivalent Circuit Schematic

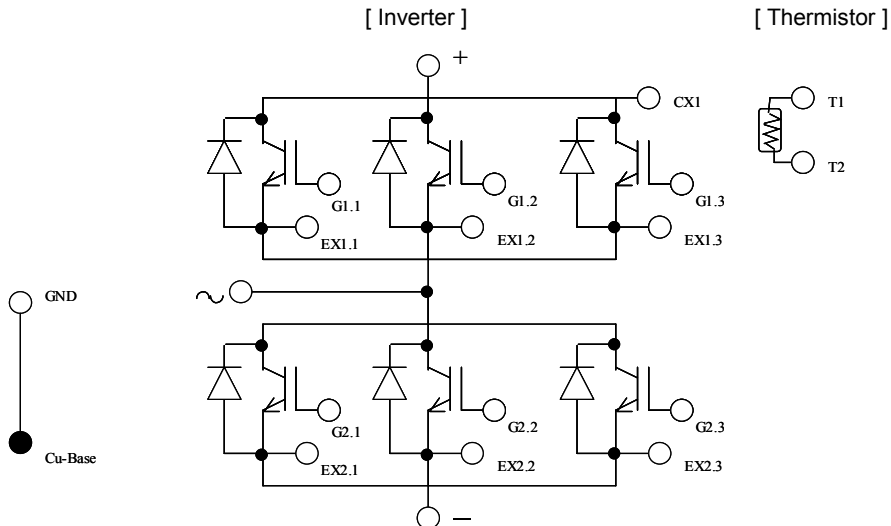

WARNING

1. This Catalog contains the product specifications, characteristics, data, materials, and structures as of March 2010. The contents are subject to change without notice for specification changes or other reasons. When using a product listed in this Catalog, be sure to obtain the latest specifications.
2. All applications described in this Catalog exemplify the use of Fuji's products for your reference only. No right or license, either express or implied, under any patent, copyright, trade secret or other intellectual property right owned by Fuji Electric Systems Co., Ltd. is (or shall be deemed) granted. Fuji Electric Systems Co., Ltd. makes no representation or warranty, whether express or implied, relating to the infringement or alleged infringement of other's intellectual property rights which may arise from the use of the applications described herein.
3. Although Fuji Electric Systems Co., Ltd. is enhancing product quality and reliability, a small percentage of semiconductor products may become faulty. When using Fuji Electric semiconductor products in your equipment, you are requested to take adequate safety measures to prevent the equipment from causing a physical injury, fire, or other problem if any of the products become faulty. It is recommended to make your design fail-safe, flame retardant, and free of malfunction.
4. The products introduced in this Catalog are intended for use in the following electronic and electrical equipment which has normal reliability requirements.
 - Computers
 - OA equipment
 - Communications equipment (terminal devices)
 - Measurement equipment
 - Machine tools
 - Audiovisual equipment
 - Electrical home appliances
 - Personal equipment
 - Industrial robots etc.
5. If you need to use a product in this Catalog for equipment requiring higher reliability than normal, such as for the equipment listed below, it is imperative to contact Fuji Electric Systems Co., Ltd. to obtain prior approval. When using these products for such equipment, take adequate measures such as a backup system to prevent the equipment from malfunctioning even if a Fuji's product incorporated in the equipment becomes faulty.
 - Transportation equipment (mounted on cars and ships)
 - Trunk communications equipment
 - Traffic-signal control equipment
 - Gas leakage detectors with an auto-shut-off feature
 - Emergency equipment for responding to disasters and anti-burglary devices
 - Safety devices
 - Medical equipment
6. Do not use products in this Catalog for the equipment requiring strict reliability such as the following and equivalents to strategic equipment (without limitation).
 - Space equipment
 - Aeronautic equipment
 - Nuclear control equipment
 - Submarine repeater equipment
7. Copyright ©1996-2008 by Fuji Electric Systems Co., Ltd. All rights reserved.
No part of this Catalog may be reproduced in any form or by any means without the express permission of Fuji Electric Systems Co., Ltd.
8. If you have any question about any portion in this Catalog, ask Fuji Electric Systems Co., Ltd. or its sales agents before using the product.
Neither Fuji Electric Systems Co., Ltd. nor its agents shall be liable for any injury caused by any use of the products not in accordance with instructions set forth herein.