

Features

- Operating voltage: 2.4V~5.5V
- Low power consumption
 - Operation: 5mA max.
 - Standby: 5µA max.
- Internal organization
 - 1K (HT24LC01): 128×8
 - 2K (HT24LC02): 256×8
- 2-wire serial interface
- Write cycle time: 5ms max.
- Automatic erase-before-write operation
- Partial page write allowed
- 8-byte Page write modes
- Write operation with built-in timer
- Hardware controlled write protection
- 40-year data retention
- 10⁶ erase/write cycles per word
- 8-pin DIP/SOP package
- 8-pin TSSOP (HT24LC02 only)
- Commercial temperature range (0°C to +70°C)

General Description

The HT24LC01/02 is a 1K/2K-bit serial read/write non-volatile memory device using the CMOS floating gate process. Its 1024/2048 bits of memory are organized into 128/256 words and each word is 8 bits. The device is optimized for use in many industrial and com-

mercial applications where low power and low voltage operation are essential. Up to eight HT24LC01/02 devices may be connected to the same two-wire bus. The HT24LC01/02 is guaranteed for 1M erase/write cycles and 40-year data retention.

Block Diagram

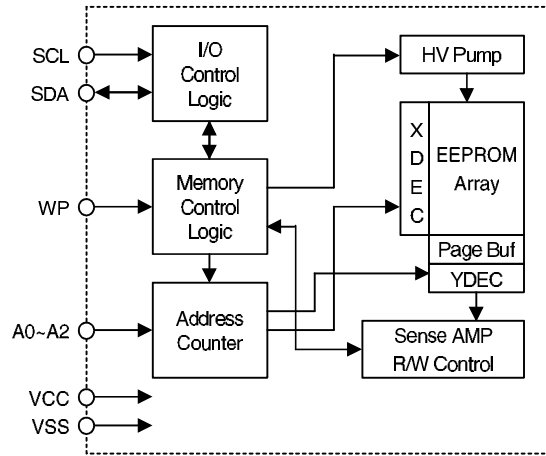

Pin Assignment

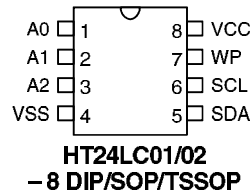

Pin Description

Pin Name	I/O	Description
A0-A2	I	Address inputs
SDA	I/O	Serial data inputs/output
SCL	I	Serial clock data input
WP	I	Write protect
VSS	—	Negative power supply
VCC	I	Positive power supply

Absolute Maximum Ratings

Operating Temperature (Commercial) 0°C to 70°C

Storage Temperature -50°C to 125°C

Applied VCC Voltage with Respect to VSS -0.3V to 6.0V

Applied Voltage on any Pin with Respect to VSS -0.3V to VCC+0.3V

Note: These are stress ratings only. Stresses exceeding the range specified under “Absolute Maximum Ratings” may cause substantial damage to the device. Functional operation of this device at other conditions beyond those listed in the specification is not implied and prolonged exposure to extreme conditions may affect device reliability.

D.C. Characteristics

Ta=0°C to 70°C

Symbol	Parameter	Test Conditions		Min.	Typ.	Max.	Unit
		VCC	Conditions				
VCC	Operating Voltage	—	—	2.4	—	5.5	V
ICC1	Operating Current	5V	Read at 100kHz	—	—	2	mA
ICC2	Operating Current	5V	Write at 100kHz	—	—	5	mA
VIL	Input Low Voltage	—	—	-1	—	0.3VCC	V
VIH	Input High Voltage	—	—	0.7VCC	—	VCC+0.5	V
VOL	Output Low Voltage	2.4V	IOL=2.1mA	—	—	0.4	V
ILI	Input Leakage Current	5V	VIN=0 or VCC	—	—	1	μA
ILO	Output Leakage Current	5V	VOUT=0 or VCC	—	—	1	μA
ISTB1	Standby Current	5V	VIN=0 or VCC	—	—	5	μA
ISTB2	Standby Current	2.4V	VIN=0 or VCC	—	—	4	μA
CIN	Input Capacitance (See Note)	—	f=1MHz 25°C	—	—	6	pF
COUT	Output Capacitance (See Note)	—	f=1MHz 25°C	—	—	8	pF

Note: These parameters are periodically sampled but not 100% tested

A.C. Characteristics

Ta=0°C to 70°C

Symbol	Parameter	Remark	Standard Mode*		V _{CC} =5V±10%		Unit
			Min.	Max.	Min.	Max.	
f _{SK}	Clock Frequency		—	100	—	400	kHz
t _{HIGH}	Clock High Time		4000	—	600	—	ns
t _{LOW}	Clock Low Time		4700	—	1200	—	ns
t _R	SDA and SCL Rise Time	Note	—	1000	—	300	ns
t _F	SDA and SCL Fall Time	Note	—	300	—	300	ns
t _{HD:STA}	START Condition Hold Time	After this period the first clock pulse is generated	4000	—	600	—	ns
t _{SU:STA}	START Condition Setup Time	Only relevant for repeated START condition	4000	—	600	—	ns
t _{HD:DAT}	Data Input Hold Time		0	—	0	—	ns
t _{SU:DAT}	Data Input Setup Time		200	—	100	—	ns
t _{SU:STO}	STOP Condition Setup Time		4000	—	600	—	ns
t _{AA}	Output Valid from Clock		—	3500	—	900	ns
t _{BUF}	Bus Free Time	Time in which the bus must be free before a new transmission can start	4700	—	1200	—	ns
t _{SP}	Input Filter Time Constant (SDA and SCL Pins)	Noise suppression time	—	100	—	50	ns
t _{WR}	Write Cycle Time		—	5	—	5	ms

Notes: These parameters are periodically sampled but not 100% tested

 * The standard mode means V_{CC}=2.4V to 5.5V

For relative timing, refer to timing diagrams

Functional Description

- **Serial clock (SCL)**
The SCL input is used for positive edge clock data into each EEPROM device and negative edge clock data out of each device.
- **Serial data (SDA)**
The SDA pin is bidirectional for serial data transfer. The pin is open-drain driven and may be wired-OR with any number of other open-drain or open collector devices.
- **A0, A1, A2**
The A2, A1 and A0 pins are device address inputs that are hard wired for the HT24LC01/02. As many as eight 1K/2K devices may be addressed on a single bus system (the device addressing is discussed in detail under the Device Addressing section).
- **Write protect (WP)**
The HT24LC01/02 has a write protect pin that provides hardware data protection. The write protect pin allows normal read/write operations when connected to the V_{SS}. When the write protect pin is connected to V_{CC}, the write protection feature is enabled and operates as shown in the following table.

WP Pin Status	Protect Array	
	HT24LC01	HT24LC02
At V _{CC}	Full Array (1K)	Full Array (2K)
At V _{SS}	Normal Read/Write Operations	

Memory organization

- **HT24LC01, 1K Serial EEPROM**
Internally organized with 128 8-bit words, the 1K requires a 7-bit data word address for random word addressing.
- **HT24LC02, 2K Serial EEPROM**
Internally organized with 256 8-bit words, the 2K requires an 8-bit data word address for random word addressing.

Device operations

- **Clock and data transition**
Data transfer may be initiated only when the

bus is not busy. During data transfer, the data line must remain stable whenever the clock line is high. Changes in data line while the clock line is high will be interpreted as a START or STOP condition.

- **Start condition**
A high-to-low transition of SDA with SCL high is a start condition which must precede any other command (refer to Start and Stop Definition Timing diagram).
- **Stop condition**
A low-to-high transition of SDA with SCL high is a stop condition. After a read sequence, the stop command will place the EEPROM in a standby power mode (refer to Start and Stop Definition Timing Diagram).
- **Acknowledge**
All addresses and data words are serially transmitted to and from the EEPROM in 8-bit words. The EEPROM sends a zero to acknowledge that it has received each word. This happens during the ninth clock cycle.

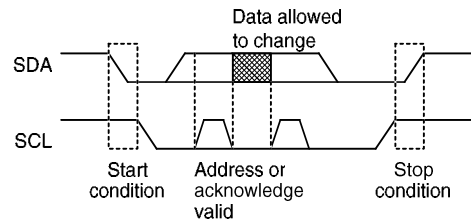

Device addressing

The 1K and 2K EEPROM devices all require an 8-bit device address word following a start condition to enable the chip for a read or write operation. The device address word consist of a mandatory one, zero sequence for the first four most significant bits (refer to the diagram showing the Device Address). This is common to all the EEPROM device.

The next three bits are the A2, A1 and A0 device address bits for the 1K/2K EEPROM. These three bits must compare to their corresponding hard-wired input pins.

The 8th bit of device address is the read/write operation select bit. A read operation is initiated if this bit is high and a write operation is initiated if this bit is low.

If the comparison of the device address succeed the EEPROM will output a zero at ACK bit. If not, the chip will return to a standby state.

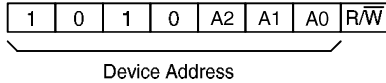

Write operations

- Byte write

A write operation requires an 8-bit data word address following the device address word and acknowledgment. Upon receipt of this address, the EEPROM will again respond with a zero and then clock in the first 8-bit data word. After receiving the 8-bit data word, the EEPROM will output a zero and the addressing device, such as a microcontroller, must terminate the write sequence with a stop condition. At this time the EEPROM enters an internally-timed write cycle to the non-volatile memory. All inputs are disabled during this write cycle and EEPROM will not respond until the write is completed (refer to Byte write timing).

- Page write

The 1K/2K EEPROM is capable of an 8-byte page write.

A page write is initiated the same as byte write, but the microcontroller does not send a stop condition after the first data word is clocked in. Instead, after the EEPROM acknowledges the receipt of the first data word, the microcontroller can transmit up to seven more data words. The EEPROM will respond with a zero after each data word received. The microcontroller must terminate the page write sequence with a stop condition.

The data word address lower three (1K/2K) bits are internally incremented following the receipt of each data word. The higher data word address bits are not incremented, retaining the memory page row location (refer to Page write timing).

- Acknowledge polling

Since the device will not acknowledge during a write cycle, this can be used to determine when the cycle is complete (this feature can be used to maximize bus throughput). Once the stop condition for a write command has been issued from the master, the device initiates the internally timed write cycle. ACK polling can be initiated immediately. This involves the master sending a start condition followed by the control byte for a write command (R/W=0). If the device is still busy with the

Byte write timing

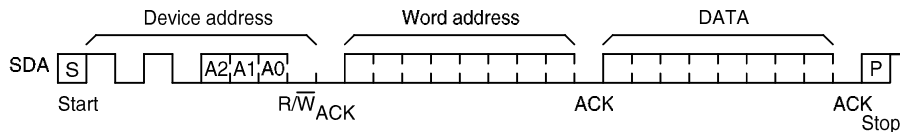

Page write timing

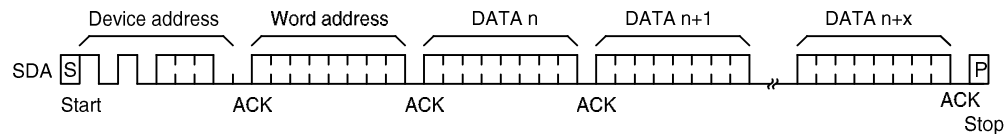

write cycle, then no ACK will be returned. If the cycle is completed, then the device will return the ACK and the master can then proceed with the next read or write command.

• Write protect

The HT24LC01/02 can be used as a serial ROM when the WP pin is connected to VCC. Programming will be inhibited and the entire memory will be write-protected.

• Read operations

Read operations are initiated the same way as write operations with the exception that the read/write select bit in the device address word is set to one. There are three read operations: current address read, random address read and sequential read.

• Current address read

The internal data word address counter maintains the last address accessed during the last read or write operation, incremented by one. This address stays valid between operations as long as the chip power is maintained. The address roll over during read from the last byte of the last memory page to the first byte of the first page. The address roll over during write from the last byte of the current page to the first byte of the same page. Once the device address with the read/write select bit set to one is clocked in and acknowledged by the EEPROM, the current address data word is serially clocked out. The microcontroller does not respond with an input zero but generates a following stop condition (refer to Current read timing).

Current read timing

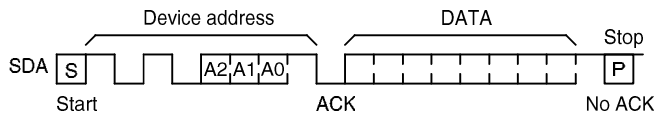

Random read timing

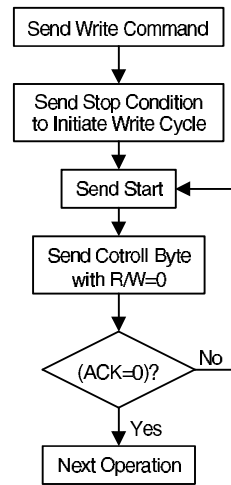
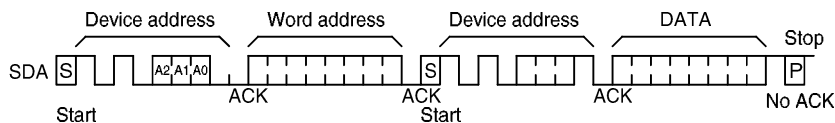

Acknowledge polling flow

• Random read

A random read requires a dummy byte write sequence to load in the data word address which is then clocked in and acknowledged by the EEPROM. The microcontroller must then generate another start condition. The microcontroller now initiates a current address read by sending a device address with the read/write select bit high. The EEPROM acknowledges the device address and serially clocks out the data word. The microcontroller does not respond with a zero but does generates a following stop condition (refer to Random read timing).

• Sequential read

Sequential reads are initiated by either a current address read or a random address read. After the microcontroller receives a data word, it responds with an acknowledgment. As long as the EEPROM receives an acknowledgment, it will continue to increment the data word address and serially clock out sequential data

words. When the memory address limit is reached, the data word address will roll over and the sequential read continues. The sequential read operation is terminated when the microcontroller does not respond with a zero but generates a following stop condition.

Sequential read timing

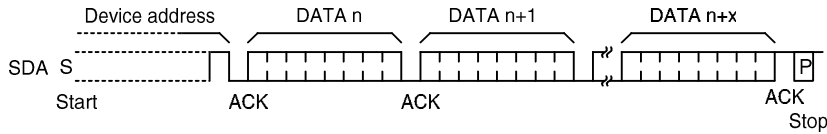

Timing Diagrams

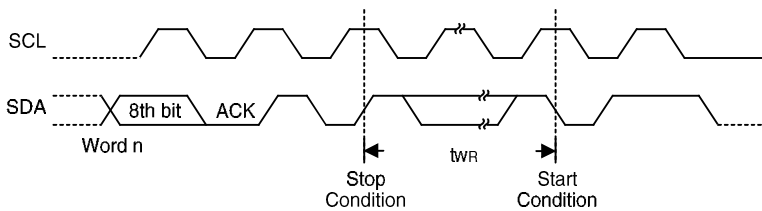
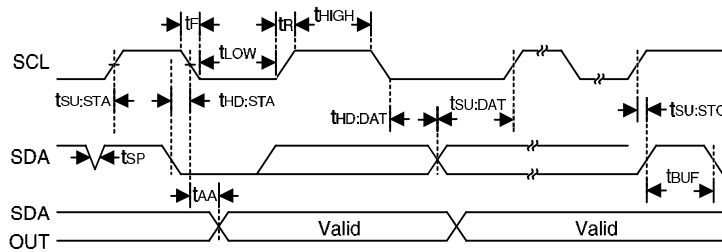

Note: The write cycle time t_{WR} is the time from a valid stop condition of a write sequence to the end of the valid start condition of sequential command.

Holtek Semiconductor Inc. (Headquarters)

No.3 Creation Rd. II, Science-based Industrial Park, Hsinchu, Taiwan, R.O.C.
Tel: 886-3-563-1999
Fax: 886-3-563-1189

Holtek Semiconductor Inc. (Taipei Office)

5F, No.576, Sec.7 Chung Hsiao E. Rd., Taipei, Taiwan, R.O.C.
Tel: 886-2-2782-9635
Fax: 886-2-2782-9636
Fax: 886-2-2782-7128 (International sales hotline)

Holtek Microelectronics Enterprises Ltd.

RM.711, Tower 2, Cheung Sha Wan Plaza, 833 Cheung Sha Wan Rd., Kowloon, Hong Kong
Tel: 852-2-745-8288
Fax: 852-2-742-8657

Copyright © 1999 by HOLTEK SEMICONDUCTOR INC.

The information appearing in this Data Sheet is believed to be accurate at the time of publication. However, Holtek assumes no responsibility arising from the use of the specifications described. The applications mentioned herein are used solely for the purpose of illustration and Holtek makes no warranty or representation that such applications will be suitable without further modification, nor recommends the use of its products for application that may present a risk to human life due to malfunction or otherwise. Holtek reserves the right to alter its products without prior notification. For the most up-to-date information, please visit our web site at <http://www.holtek.com.tw>.